

A. 根據批地文件規定須興建並提供予政府或供公眾使用的設施

1. 行人天橋相關結構及未來行人天橋相關結構

批地文件相關條文：

特別條款第(12)(a)、(b)、(e)、(f)及(g)條

- 「(a) 承批人於本協議日期已自費在該地段內搭建、提供及興建支柱及其他結構性支撐物及接駁位（該等支柱及其他結構性支撐物及接駁位在下文合稱「行人天橋相關結構」），用以連接該地段至於在此夾附的圖則Ia上U1及V1兩點之間標示的位置擁有最少3.0米內部淨闊度、最少2.4米內部通行高度及由香港主水平基準以上11.7米至香港主水平基準以上18.6米之間的最少淨空高度並在此夾附的圖則Ia上以“EW”標示之現有行人天橋（下稱「現有行人天橋」）。此後承批人須自費管理及保養行人天橋相關結構，以使署長在各方面滿意。
- (b) 承批人須於2026年6月30日或C地盤到期日或經延展的到期日（如適用）起計96個月屆滿當日（以較後者為準）或其他署長可能批准的日期或時限或之前自費及使署長在各方面滿意下在該地段內以署長要求或批准的物料、標準、高度、定線、布局及設計搭建、提供及建造署長可能要求的支柱及其他結構性支撐物及接駁位（該等支柱及其他結構性支撐物及接駁位在下文合稱「未來行人天橋相關結構」），並在此後自費管理及保養未來行人天橋相關結構，以連接該地段至可能位於在此夾附的圖則Ia上U3及V3兩點之間標示的位置或位於或經過其他由署長書面批准的位置或點，並擁有全由署長決定的最少內部淨闊度、最少內部通行高度及何等水平之間的最少淨空高度之未來行人天橋。為免生疑問，就未來行人天橋會否建成並無保證。
- (e) 於整個在此協定的批租期內，政府及其人員、承辦商、代理人、工人、僱員及其他正式獲授權人士有權帶同或不帶同工具、設備、裝置、機器或車輛毋須成本、費用及開支在所有時間進入或經過該地段或其任何一個或多個部分之內、之上或進入或經過在其上搭建的任何一幢或多幢建築物之內、下、上或之上：
- (i) 以進行以連接未來行人天橋至未來行人天橋相關結構為目的之工程（該等連接工程在下稱「連接工程」）並在此後享有連接工程、現有行人天橋及未來行人天橋的支撐地役權；及
- (ii) 以維修及保養連接工程、現有行人天橋及未來行人天橋。
- 政府及其人員、承辦商、代理人、工人及僱員毋須就因行使其根據本分條授予之權力引起或相關而令承批人蒙受的任何損失、損害、滋擾或侵擾承擔任何法律責任，而承批人亦不得就任何該等損失、損害、滋擾或侵擾向其索償。
- (f) 當署長要求時，承批人須自費及在署長各方面滿意下進行所有署長要求或批准的工程臨時封閉在該地段上已建或擬建的一幢或多幢建築物的出入口，以連接現有行人天橋及未來行人天橋。臨時封閉處的所有必需的保養工程須由承批人負責，並由其自費展開以使署長滿意。

- (g) 承批人已在本協議日期提供並須於整個在此協定的批租期內自費並在署長各方面滿意下保持一條開放予公眾免費及無阻礙地使用的公眾行人通道，以在特別條款第(46)(a)條定義的黃竹坑站的營運時間內連接在此夾附的圖則Ia上U1及V1兩點之間標示的位置的現有行人天橋及在此夾附的圖則Ia上從U2至V2各點之間標示的位置的地面水平。」

公契相關條文：

主公契中「屋苑公用地方」及「車站」的定義

「『屋苑公用地方』指屋苑中擬供多於一期數的業主而非任何一名業主、一群業主或某一期數的業主獨家使用的部分，包括但不限於設施坑道、未來行人天橋相關結構（按批地文件特別條款第(12)(b)條定義）、通道範圍、位於該土地以外的該部分行人連接通道（僅為管理及保養的目的而包含在此定義中）、部分按批地文件特別條款第(59)(c)條提供的有蓋行人通道（僅為管理及保養的目的而包含位於該土地以外的有蓋行人通道）、護牆、結構牆及柱、建於屋苑及服務多於一期數的建築物的地基及其他結構部分（但不包括構成車站或車廠一部分者）、屋苑公用道路、及所有其他位於屋苑內及並非供任何一名業主、一群業主或某一期數的業主獨家享用的公用地方（但不包括構成住宅發展項目公用地方或就某一期數訂立的副公契或分副公契或單邊契據中劃定或將劃定為某一期數的公用地方的地方）。屋苑公用地方將於就任何一期數訂立的副公契或分副公契或單邊契據附夾的圖則上更詳細標明。」

「『車站』指 (i) 建於該土地的黃竹坑站地盤（按批地文件特別條款第(1)(h)條定義）上或內的黃竹坑站（按批地文件特別條款第(46)(a)條定義），包括一個鐵路車站及附屬鐵路構築物、設施及道路、(ii) 批地文件特別條款第(70)條提述為黃竹坑站的營運需要而於黃竹坑站地盤內提供或將提供予汽車停泊、調動及上落客貨的停車位及(iii) 行人天橋相關結構（按批地文件特別條款第(12)(a)條定義）；為免生疑，以下並不構成車站的一部分：所有服務車廠或屋苑或其任何部分的公用事業、服務、槽、井及設施及車廠及屋苑的所有裝飾物料。」

副公契中「第二期中的屋苑公用地方」的定義

「『第二期中的屋苑公用地方』指位於第二期內擬供予屋苑的業主而非任何一名業主、一群業主或某一期數的業主獨家使用的該部分屋苑公用地方，包括但不限於未來行人天橋相關結構（定義見批地文件特別條款第(12)(b)條）、第二期中的行人通道（僅為管理及保養的目的而包括已建或擬建毗鄰B地盤但位於該土地以外的該部分）、第二期綠化範圍的其中部分、花槽、消防員升降機大堂、暢通易達升降機、消防喉轆、電線槽、防火閘、走廊、樓梯及梯台、護牆、結構牆及柱、建於屋苑及服務多於一期數及位於B地盤以內的建築物的地基及其他結構部分（但不包括構成車站或車廠一部分者），但不包括第二期中的住宅發展項目公用地方、第二期公用地方、第二期住宅公用地方及第二期停車場公用地方；第二期中的屋苑公用地方在經認可人士核證為準確並附夾於副公契的圖則上為辨認用途以靛藍色、靛藍色加黑交叉線及靛藍色加黑交叉線和黑點顯示。」

主公契E章第8(c)條

「港鐵作為車站及車廠的業主須自費負責提供及保持批地文件特別條款第(12)(g)條所要求的公眾行人通道，並於黃竹坑站（按批地文件特別條款第(46)(a)條定義）營運時間內開放予公眾免費及無阻礙地使用，以使署長各方面滿意。」

主公契第二附表第II部分的第2(b)條

「管理人有權帶同或不帶同測量師、工人及其他人士進行署長要求的必要工程臨時關閉建於該土地上的任何建築物（不包括政府樓宇）的任何出口，以便將行人通道、地下通道或行人天橋按批地文件特別條款第(12)條連接至建於該土地上的建築物、的未來行人天橋相關結構（按批地文件特別條款第(12)(b)條定義）或連接至行人連接通道及有蓋行人通道（於批地文件特別條款第(59)(c)條提述）、或按批地文件要求連接至建於該土地以外的其他構築物或建築物。管理人在進行上述工程時必須以書面通知業主其於工程進行期間不可使用該土地及發展項目的有關地方或部分，而業主必須遵守有關通知的要求，惟不得阻礙政府樓宇的出入及不得干擾政府樓宇的正當使用及享用。」

主公契第二附表第II部分的第4(a)條

「受限於批地文件的條文及財政司司長法團作為政府樓宇業主於批地文件、本主公契及任何副公契或分副公契或單邊契據下的權利、地役權及特權，所有公眾人士有權：

- (a) 於按批地文件特別條款第(46)(a)條定義的黃竹坑站的營運時間內使用港鐵按批地文件特別條款第(12)(g)條提供的行人通道；

惟公眾人士行使前述權利時不能影響或損害於批地文件、本主公契及任何副公契或分副公契或單邊契據底下保留予財政司司長法團作為政府樓宇業主的權利、地役權及特權。」

副公契第二附表第II部分的第3(a)條

「在無損主公契第二附表第II部分第3條保留予港鐵之權利之一般性為前提下：

- (a) 港鐵具有權力帶同一切所需的工具、設備、機械及物料，帶同或不帶同傭工、工人或其他人，在一切合理時間之內，在給予事先書面通知後（緊急情況除外）進入B地盤的任何部分（港鐵已出售或轉讓的單位除外），以便按其所需不時在地盤B內的任何一點或部分豎立、提供及興建行人天橋、柱、結構支撐及連接，包括但不限於未來行人天橋相關結構（按批地文件特別條款第12(b)條定義），惟應盡量減低造成的滋擾及就其造成的任何損壞作出彌補。」

2. 綠色範圍及該等構築物

批地文件相關條文：

特別條款第(13)(a)條

「(a) 承批人須：

- (i) 於2026年3月31日或D地盤到期日或經延展的到期日（如適用）起計84個月屆滿當日（以較後者為準）或其他署長可能批准的日期或時限或之前自費並按署長批准的方式、物料、標準、水平、定線和設計並使署長在各方面滿意下：

- (I) 在此所夾附的圖則Ia上以綠色顯示的部份（下稱「綠色範圍」）鋪設及平整部份未來公共道路；及
- (II) 提供及建造該等橋樑、隧道、上跨路、下通道、下水道、高架管道、天橋、行人道、道路或署長以其酌情要求的其他構築物（在下文合稱「該等構築物」）使建築、車輛、行人的交通得以在綠色範圍內往來；
- (ii) 於2026年3月31日或D地盤到期日或經延展的到期日（如適用）起計84個月屆滿當日（以較後者為準）或其他署長可能批准的日期或時限或之前自費在綠色範圍鋪設路面、建造路緣及渠道，並提供署長規定的溝渠、污水渠、排水渠、消防栓連接駁至總水管的水管、服務設施、街燈、交通標誌、街道設施、路面標記及植物，以使署長滿意；及
- (iii) 自費保養綠色範圍連同該等構築物及在其上或其內建造、安裝及提供的所有構築物、路面、溝渠、污水渠、排水渠、消防栓、服務設施、街燈、交通標誌、街道設施、路面標記和植物以使署長滿意，直至綠色範圍的管有權根據特別條款第(14)條交還為止。」

特別條款第(14)條

「僅為了進行特別條款第(13)條指明的所需工程，綠色範圍的管有權將會在本協議日期當日授予承批人。綠色範圍須於要求時交還予政府，並在任何情況下於署長發信表明此等條款以獲符合並使其滿意之日視為已交還予政府。承批人須在其管有綠色範圍的所有合理時間內准許所有政府及公共車輛及行人自由進入及通過綠色範圍，並確保該項進入的權利不受進行的工程干擾或阻礙，不論有關工程是否依據特別條款第(13)條進行。」

特別條款第(15)條

「在未獲署長事先書面同意之前，承批人不得使用綠色範圍作儲存用途或作搭建任何臨時構築物或作任何進行特別條款第(13)條指明之工程以外之任何用途。」

特別條款第(16)條

「承批人須在其管有綠色範圍期間的所有合理時間內准許政府、署長及其人員、承辦商及代理人及任何獲其授權之人士有權進入、離開及再進入該地段及綠色範圍，以視察、檢查及監督任何為遵從特別條款第(13)(a)條而進行的工程及進行、視察、檢查及監督特別條款第(13)(b)條下的工程及任何其他在綠色範圍內署長認為需要的工程。」

公契相關條文：

主公契中「綠色範圍」及「該等構築物」的定義

「『綠色範圍』指該部分按批地文件特別條款第(13)(a)(i)(l)條由港鐵於批地文件附夾的圖則Ia上以綠色顯示的範圍鋪設及平整的公共道路及擬鋪設及平整的未來公共道路。」

「『該等構築物』指按批地文件特別條款第(13)(a)(i)(II)條定義的該等構築物。」

主公契E章第1(b)條

「為免生疑，受限於批地文件及本主公契的條文，港鐵作為批地文件下該土地的原始承批人進行綠色範圍、該等構築物、綠色圓點範圍及綠色圓點範圍構築物的興建，並承擔有關建築成本，在港鐵完成興建綠色範圍、該等構築物、綠色圓點範圍及綠色圓點範圍構築物或其任何一部分而使署長滿意時，綠色範圍、該等構築物、綠色圓點範圍及綠色圓點範圍構築物或其任何已落成的部分將由管理人根據本主公契管理及控制，直至交還予政府為止。」

主公契F章第1條

「受限於本章第12條，應按情況需要不時舉行屋苑業主的會議，以討論及決議以下所述與屋苑及/或（按批地文件交還予政府前）綠色範圍、該等構築物、綠色圓點範圍及綠色圓點範圍構築物相關的事宜，而本章的條文適用於有關會議。屋苑業主會議的程序將由屋苑的業主決定。」

主公契F章第9(a)條

「在正式召開的會議上由親自出席會議的業主或投票代表投票，並以過半數票通過的任何有關屋苑及/或綠色範圍、該等構築物、綠色圓點範圍及綠色圓點範圍構築物相關的決議對所有業主具約束力（於本章第11條提述的事項除外），但是：

- (i) 會議通知必須正式發出並列明擬通過有關事項的議案；
- (ii) 擬在任何該等會議上通過但未有在該會議通知中列明的任何事項之決議均無效；
- (iii) 除非本主公契另有指明，凡擬更改、修訂及抵觸本主公契的決議一概無效；
- (iv) 與香港法院的任何命令、裁決或判決或任何法例的任何強制性條款抵觸或相反的決議一概無效；
- (v) 任何決議均不得影響政府樓宇或其任何部分的使用、操作或保養，或供政府樓宇使用的服務及設施；
- (vi) 任何在港鐵的合理意見下認為可能影響地下鐵路、地下鐵路構築物及裝置、車站或車廠或其任何部分的決議，須受限於港鐵的同意；
- (vii) 任何決議均不得破壞、干擾、阻礙或危害地下鐵路、地下鐵路構築物及裝置、車站或車廠或其任何部分的建造、使用、操作、保養或安全。」

主公契G章第1(b)(ii)條

「發展項目業主委員會的職能為：

- (ii) 討論與維修及管理屋苑公用地方、屋苑公用服務及設施、住宅發展項目公用地方、住宅發展項目公用服務及設施、綠色範圍、該等構築物、綠色圓點範圍及綠色圓點範圍構築物相關的事宜並將其意見告知管理人；」

主公契I章第1(a)條

「受限於該條例的條文，及受限於財政司司長法團作為政府樓宇業主於本主公契、任何副公契或分副公契或單邊契據及批地文件下的權利、地役權及特權，就屋苑中任何已按本主公契訂立副公契的部分（政府樓宇除外）及（按批地文件交還予政府前）綠色範圍、該等構築物、綠色圓點範圍及綠色圓點範圍構築物，管理人有權按本主公契的條文代表所有業主（財政司司長法團作為政府樓宇業主除外）作出任何為管理該土地及屋苑的相關部分（政府樓宇除外）及綠色範圍、該等構築物、綠色圓點範圍及綠色圓點範圍構築物而必要或適宜的行動及事宜及任何與其合理地相關的事宜，而每一位業主（財政司司長法團作為政府樓宇業主除外）不可撤銷地委任管理人作為有關任何涉及公用地方及公用服務或設施及其於本主公契或任何副公契或分副公契下妥獲授權之所有其他事宜的代理人。」

主公契I章第2條

「受限於該條例及本主公契的條文，公用地方、公用服務及設施及（按批地文件交還予政府前）綠色範圍、該等構築物、綠色圓點範圍及綠色圓點範圍構築物將由管理人獨自控制。」

主公契I章第4(b)條

「管理人或（如無管理人）業主立案法團或發展項目業主委員會的主席有權代表該土地的所有業主接受政府就交付綠色範圍、該等構築物、綠色圓點範圍及/或綠色圓點範圍構築物或其任何部分的管有權送達的通知或要求及按批地文件交付綠色範圍、該等構築物、綠色圓點範圍及/或綠色圓點範圍構築物或其任何部分予政府。」

主公契J章第5(b)(II)條

「即使本主公契有另有規定，車站及車廠的業主須分擔(i)屋苑公用地方及設施管理副預算案的成本及支出，但僅限於因綠色範圍、該等構築物、綠色圓點範圍、綠色圓點範圍構築物及通道範圍而非其他部分的保養及管理引致的成本及支出，及(ii)有關綠色範圍、該等構築物、綠色圓點範圍、綠色圓點範圍構築物及通道範圍而非其他部分的資本性質的主要工程或並非預期每年支出的開支，並作出供款，計算基準為車站及車廠的建築樓面總面積佔車站及車廠的建築樓面總面積加屋苑所有當時已落成部分的建築樓面總面積（「已落成的屋苑建築樓面總面積」）的比例。管理人須於屋苑公用地方及設施管理副預算案下準備分副預算案，以顯示來年就綠色範圍、該等構築物、綠色圓點範圍、綠色圓點範圍構築物及通道範圍的保養及管理的預計年度成本及支出，及就綠色範圍、該等構築物、綠色圓點範圍、綠色圓點範圍構築物及通道範圍的資本性質的主要工程或並非預期每年支出的該等開支，並將一份分副預算案的副本送遞予車站及車廠的業主供其參考。就本分條而言，車站及車廠的建築樓面總面積為53,726平方米，而「已落成的屋苑總建築樓面面積」指經屋苑或相關期數的認可人士核證的屋苑已落成部分的實際樓面總面積，不論該樓面總面積於《建築物條例》或批地文件下是否計入樓面總面積。」

3. 綠色圓點範圍及綠色圓點範圍構築物

批地文件相關條文：

特別條款第(17)(a)條

「(a) 承批人須：

(i) 於2026年6月30日或C地盤到期日或經延展的到期日（如適用）起計96個月屆滿當日（以較後者為準）或其他署長可能批准的日期或時限或之前自費並按署長批准的方式、物料、標準、水平、定線和設計並使署長在各方面滿意下：

- (I) 鋪設及平整位於在此夾附的圖則Ia上以綠色圓點顯示之範圍（下稱「綠色圓點範圍」）內一個或多個地面層以下2米至一個或多個地面層以上5.5米之間的空氣層內的部分未來公共道路。為免生疑問，綠色圓點範圍的空氣層與第五預留範圍相同；及
- (II) 提供及建造該等橋樑、隧道、上跨路、下通道、下水道、高架管道、天橋、行人道、道路或署長以其酌情要求的其他構築物（在下文合稱「綠色圓點範圍構築物」）

使建築、車輛、行人的交通得以在綠色圓點範圍內往來；

(ii) 於2026年6月30日或C地盤到期日或經延展的到期日（如適用）起計96個月屆滿當日（以較後者為準）或其他署長可能批准的日期或時限或之前自費在綠色圓點範圍鋪設路面、建造路緣及渠道，並提供署長規定的溝渠、污水渠、排水渠、消防栓連接駁至總水管的水管、服務設施、街燈、交通標誌、街道設施、路面標記及植物，以使署長滿意；及

(iii) 自費保養綠色圓點範圍連同綠色圓點範圍構築物及其上或其內建造、安裝及提供的所有構築物、路面、溝渠、污水渠、排水渠、消防栓、服務設施、街燈、交通標誌、街道設施、路面標記和植物以使署長滿意，直至綠色圓點範圍的管有權根據特別條款第(18)條交還為止。」

特別條款第(18)條

「僅為了進行特別條款第(17)條指明的所需工程，綠色圓點範圍的管有權將會在本協議日期當日授予承批人。綠色圓點範圍須於要求時交還予政府，並在任何情況下於署長發信表明此等條款以獲符合並使其滿意之日視為已交還予政府。承批人須在其管有綠色圓點範圍的所有合理時間內准許所有政府及公共車輛及行人自由進入及通過綠色圓點範圍，並確保該項進入的權利不受進行的工程干擾或阻礙，不論有關工程是否依據特別條款第(17)條進行。」

特別條款第(19)條

「在未獲署長事先書面同意之前，承批人不得使用綠色圓點範圍作儲存用途或作搭建任何臨時構築物或作任何進行特別條款第(17)條指明之工程以外之任何用途。」

特別條款第(20)條

「承批人須在其管有綠色圓點範圍期間的所有合理時間內准許政府、署長及其人員、承辦商及代理人及任何獲其授權之人士有權進入、離開及再進入該地段及綠色圓點範圍，以視察、檢查

及監督任何為遵從特別條款第(17)(a)條而進行的工程及進行、視察、檢查及監督特別條款第(17)(b)條下的工程及任何其他在綠色圓點範圍內署長認為需要的工程。」

公契相關條文：

主公契中「綠色圓點範圍」及「綠色圓點範圍構築物」的定義

「『綠色圓點範圍』指該部分按批地文件特別條款第(17)(a)(i)(I)條由港鐵於批地文件附夾的圖則Ia上以綠色圓點顯示之範圍內的地面層以下2米至地面層以上5.5米之間的空氣層內鋪設及平整的公共道路及擬鋪設及興建的未來公共道路。」

「『綠色圓點範圍構築物』指按批地文件特別條款第(17)(a)(i)(II)條定義的綠色圓點範圍構築物。」

主公契E章第1(b)條

「為免生疑，受限於批地文件及本主公契的條文，港鐵作為批地文件下該土地的原始承批人進行綠色範圍、該等構築物、綠色圓點範圍及綠色圓點範圍構築物的興建，並承擔有關建築成本，在港鐵完成興建綠色範圍、該等構築物、綠色圓點範圍及綠色圓點範圍構築物或其任何一部分而使署長滿意時，綠色範圍、該等構築物、綠色圓點範圍及綠色圓點範圍構築物或其任何已落成的部分將由管理人根據本主公契管理及控制，直至交還予政府為止。」

主公契F章第1條

「受限於本章第12條，應按情況需要不時舉行屋苑業主的會議，以討論及決議以下所述與屋苑及/或（按批地文件交還予政府前）綠色範圍、該等構築物、綠色圓點範圍及綠色圓點範圍構築物相關的事宜，而本章的條文適用於有關會議。屋苑業主會議的程序將由屋苑的業主決定。」

主公契F章第9(a)條

「在正式召開的會議上由親自出席會議的業主或投票代表投票，並以過半數票通過的任何有關屋苑及/或綠色範圍、該等構築物、綠色圓點範圍及綠色圓點範圍構築物相關的決議對所有業主具約束力（於本章第11條提述的事項除外），但是：

- (i) 會議通知必須正式發出並列明擬通過有關事項的議案；
- (ii) 擬在任何該等會議上通過但未有在該會議通知中列明的任何事項之決議均無效；
- (iii) 除非本主公契另有指明，凡擬更改、修訂及抵觸本主公契的決議一概無效；
- (iv) 與香港法院的任何命令、裁決或判決或任何法例的任何強制性條款抵觸或相反的決議一概無效；
- (v) 任何決議均不得影響政府樓宇或其任何部分的使用、操作或保養，或供政府樓宇使用的服務及設施；
- (vi) 任何在港鐵的合理意見下認為可能影響地下鐵路、地下鐵路構築物及裝置、車站或車廠或其任何部分的決議，須受限於港鐵的同意；
- (vii) 任何決議均不得破壞、干擾、阻礙或危害地下鐵路、地下鐵路構築物及裝置、車站或車廠或其任何部分的建造、使用、操作、保養或安全。」

主公契G章第1(b)(ii)條

「發展項目業主委員會的職能為：

- (ii) 討論與維修及管理屋苑公用地方、屋苑公用服務及設施、住宅發展項目公用地方、住宅發展項目公用服務及設施、綠色範圍、該等構築物、綠色圓點範圍及綠色圓點範圍構築物相關的事宜並將其意見告知管理人；」

主公契I章第1(a)條

「受限於該條例的條文，及受限於財政司司長法團作為政府樓宇業主於本主公契、任何副公契或分副公契或單邊契據及批地文件下的權利、地役權及特權，就屋苑中任何已按本主公契訂立副公契的部分（政府樓宇除外）及（按批地文件交還予政府前）綠色範圍、該等構築物、綠色圓點範圍及綠色圓點範圍構築物，管理人有權按本主公契的條文代表所有業主（財政司司長法團作為政府樓宇業主除外）作出任何為管理該土地及屋苑的相關部分（政府樓宇除外）及綠色範圍、該等構築物、綠色圓點範圍及綠色圓點範圍構築物而必要或適宜的行動及事宜及任何與其合理地相關的事宜，而每一位業主（財政司司長法團作為政府樓宇業主除外）不可撤銷地委任管理人作為有關任何涉及公用地方及公用服務或設施及其於本主公契或任何副公契或分副公契下妥獲授權之所有其他事宜的代理人。」

主公契I章第2條

「受限於該條例及本主公契的條文，公用地方、公用服務及設施及（按批地文件交還予政府前）綠色範圍、該等構築物、綠色圓點範圍及綠色圓點範圍構築物將由管理人獨自控制。」

主公契I章第4(b)條

「管理人或（如無管理人）業主立案法團或發展項目業主委員會的主席有權代表該土地的所有業主接受政府就交付綠色範圍、該等構築物、綠色圓點範圍及/或綠色圓點範圍構築物或其任何部分的管有權送達的通知或要求及按批地文件交付綠色範圍、該等構築物、綠色圓點範圍及/或綠色圓點範圍構築物或其任何部分予政府。」

主公契J章第5(b)(II)條

「即使本主公契有另有規定，車站及車廠的業主須分擔(i)屋苑公用地方及設施管理副預算案的成本及支出，但僅限於因綠色範圍、該等構築物、綠色圓點範圍、綠色圓點範圍構築物及通道範圍而非其他部分的保養及管理引致的成本及支出，及(ii)有關綠色範圍、該等構築物、綠色圓點範圍、綠色圓點範圍構築物及通道範圍而非其他部分的資本性質的主要工程或並非預期每年支出的開支，並作出供款，計算基準為車站及車廠的建築樓面總面積佔車站及車廠的建築樓面總面積加屋苑所有當時已落成部分的建築樓面總面積（「已落成的屋苑建築樓面總面積」）的比例。管理人須於屋苑公用地方及設施管理副預算案下準備分副預算案，以顯示來年就綠色範圍、該等構築物、綠色圓點範圍、綠色圓點範圍構築物及通道範圍的保養及管理的預計年度成本及支出，及就綠色範圍、該等構築物、綠色圓點範圍、綠色圓點範圍構築物及通道範圍的資本性質的主要工程或並非預期每年支出的該等開支，並將一份分副預算案的副本送遞予車站及車廠的業主供其參考。就本分條而言，車站及車廠的建築樓面總面積為53,726平方米，而「已落成的屋苑總建築樓面面積」指經屋苑或相關期數的認可人士核證的屋苑已落成部分的實際樓面總面積，不論該樓面總面積於《建築物條例》或批地文件下是否計入樓面總面積。」

4. 政府樓宇

批地文件相關條文：

特別條款第(29)(a)及(b)條

「(a) 承批人須自費及使署長在各方面滿意下在該地段內以良好工藝及依照在此夾附的技術附表（下稱「技術附表」）及根據特別條款第(30)(a)條批核的圖則搭建、興建及提供以下樓宇：

- (i) 在本協議日期起計84個月內完成一所淨作業樓面面積達557平方米的中度智障人士宿舍（下稱「宿舍」），並使其適合佔用及運作；及
- (ii) 在本協議日期起計84個月內完成一所淨作業樓面面積達653平方米的綜合職業康復服務中心（下稱「康復服務中心」），並使其適合佔用及運作；

（該等樓宇連同署長以其絕對酌情權決定及專屬於該等樓宇的任何其他範圍、設施、服務及設備（其決定為最終並對承批人有約束力）在下文合稱「政府樓宇」）。

(b) 政府保留權利在任何時間以其絕對酌情權改動或變更政府樓宇或其任何部分之用途。」

特別條款第(36)(a)條

「承批人須在署長要求時將此特別條款第(b)分條指明的不可分割份數或其任何部分連同政府樓宇或其部分的獨家使用、佔用及享用權，在空置管有及沒有產權負擔下由承批人自費轉讓予財政司司長法團（在文義許可下此詞包括其繼承人及承讓人），而承批人須在署長可能以書面方式指明的一個或多個時間內完成已根據特別條款第(35)條獲發完工證明書的政府樓宇或其任何部分之轉讓。」

特別條款第(38)條

「署長有權在政府樓宇進行根據特別條款第(36)條的轉讓前要求交出而已根據特別條款第(35)條獲發完工證明書的政府樓宇或署長需要的部分的空置管有權，而承批人須按該要求以署長認為合適的條款及條件將有關空置管有權交予政府，供政府獨家使用、佔用及運作。」

公契相關條文：

主公契中「政府樓宇」的定義

「『政府樓宇』指分別按批地文件特別條款第(29)(a)(i)條及第(29)(a)(ii)條定義的宿舍及康復服務中心，各自連同任何其他由署長按批地文件特別條款第(29)條以其絕對酌情權決定於該土地上興建或擬興建並作為發展項目一部分的專屬範圍、設施、服務及裝置。」

主公契E章第9(a)條

「財政司司長法團作為政府樓宇業主須負責保養及管理政府樓宇（物件除外），而非發展項目的任何其他部分或綠色範圍、該等構築物、綠色圓點範圍及綠色圓點範圍構築物的任何部分。財政司司長法團作為政府樓宇業主僅須按批地文件特別條款第(64)(a)(iv)(I)(2)條負責支付有關實際上服務政府樓宇或由該處佔用人、其傭工、承辦商、代理人或訪客使用的設施或服務的管理及保養費用，惟前提是財政司司長法團的責任將由政府產業署署長或署長為此提名的人士釐定，且於任何情況下須支付的管理及保養費用的比例均不得超過政府樓宇的樓面總面積佔（就有關該土地的管理及保養費用而言）所有已建或擬建於該土地上的建築物的樓面總面積或（就有關A地盤的管理及保養費而言）所有已建或擬建於A地盤上的建築物的樓面總面積的比例，有關的維修及管理費用的繳付責任將由政府樓宇的轉讓契據的日期或接收政府樓宇的日期起計，以較早者為準；另一前提為除非及直至政府產業署署長或署長為此提名的人士已經以書面方式批准有關金額，財政司司長法團作為政府樓宇業主並無責任支付任何管理及保養費用。財政司司長法團作為政府樓宇業主並無責任就政府產業署署長或署長就此提名的其他人士認為並非直接服務或惠及政府樓宇的發展項目任何其他部分（不論是否屬公用地方）或綠色範圍、該等構築物、綠色圓點範圍及綠色圓點範圍構築物的任何部分或任何設施或服務的管理及保養費用作出任何供款。財政司司長法團作為政府樓宇業主毋須就管理費作出任何供款。」

主公契F章第9(a)(v)條

「在正式召開的會議上由親自出席會議的業主或投票代表投票，並以過半數票通過的任何有關屋苑及/或綠色範圍、該等構築物、綠色圓點範圍及綠色圓點範圍構築物相關的決議對所有業主具約束力（於本章第11條提述的事項除外），但是：

- (v) 任何決議均不得影響政府樓宇或其任何部分的使用、操作或保養，或供政府樓宇使用的服務及設施。」

主公契G章第1(e)條

「任何發展項目業主委員會或期數的業主附屬委員會的決議均不得與本主公契條文或香港法院的任何判決或命令相抵觸，亦不得影響政府樓宇或其任何部分的使用、操作或保養。」

主公契G章第12條

「發展項目業主委員會須邀請財政司司長法團作為政府樓宇業主提名作其代表的人士出席其所有會議，並按本主公契L章第3(a)條向該等人士免費提供該會議的議程、通知及記錄。財政司司長法團作為政府樓宇業主須不時以書面形式通知發展項目業主委員會其代表。出席任何發展項目業主委員會會議之財政司司長法團作為政府樓宇業主的代表有權將其對討論事項的意見告知委員會，但無權投票。」

主公契J章第1條的但書

「惟受本主公契本章第5(b)(II)條及E章第9(a)條所限，港鐵作為車站及車廠的業主（而非以其其他身份）及政府樓宇的業主不須攤付管理人因保養及管理屋苑產生的任何成本、費用及開支，政府樓宇的業主亦不須攤付本章第2條及第9條分別提述的特別基金或按金，以及保險費、泥頭清理費、利息、懲罰費用或性質類似的費用。」

主公契K章第8條

「建築規則及裝修規則（包括任何根據本章第3條所作的更改及修訂）不能不利地影響或干擾政府樓宇或其任何部分的使用、操作及享用，亦不能阻止、阻礙或限制政府樓宇或其任何部分的出入。」

主公契第二附表第I部分的第2條

- (a) 即使本主公契或任何副公契或副分公契另有規定，財政司司長法團、其承租人、租客、被許可人、及任何獲授權人士及政府樓宇或其任何部分當時的業主及佔用人有以下權利、特權及地役權：
- (i) 政府樓宇受庇護、支撐物及保護的權利；
 - (ii) 在任何時候讓氣體、電力、食水、污水、空調、電話及所有其他服務自由透過現時或於批租期內於該土地的任何部分及發展項目的任何部分鋪設或越過的溝渠、污水管、排水渠、排煙管、管線、管道、水道、電纜、水管、電線及其他導體往來政府樓宇的權利；
 - (iii) 於任何時候全權酌情，自費改動、改道、更改、重鋪或還原任何政府樓宇或其任何部分專用的服務及設施（「政府樓宇服務」）的權利，而無須向其他業主或管理人支付任何費用，亦無須取得其批准或同意，惟在進行上述政府樓宇服務的改動、改道、更改、重鋪或還原工程時必須採取適當及足夠的預防措施，以確保不會對該土地內及服務除政府樓宇外該土地上發展項目的所有部分的該等服務及設施造成損壞；
 - (iv) 為正確地使用及享用政府樓宇或其任何部分的目的通行及再通行、進出、往返及使用該土地的公用地方或發展項目的公用地方，以及使用和享用該土地或發展項目內任何公用設施的權利；
 - (v) 在所有合理時間不論是否連同測量師、承辦商、工人及其他人，及不論是否攜帶車輛、機械、設備、物料及機器進入該土地或發展項目任何部分的權利，以便擴建政府樓宇或其任何部分或進行保養、維修、加建、改建及其他工程，以及進行政府樓宇服務或其任何部分的保養、維修、改建、改道、更改、重鋪、還原及其他工程；
 - (vi) 按署長要求享有暢通無阻進出政府樓宇的通行權；
 - (vii) 在財政司司長法團認為合適時在政府樓宇或其任何部分內、周圍及邊界上的牆、柱及其他結構組件安裝、建設、展示、陳列、保養、維修、拆除和更新招牌及廣告的專有權，及進入該土地或其任何部分或發展項目任何部分的通行權，不論是否連同受僱人、工人及其他人，及不論是否攜帶機械、設備、機器及物料，以便檢查、安裝、建設、展示、陳列、保養、維修、拆除及更新此等招牌及廣告；
 - (viii) 固定於政府樓宇的天台樓板、牆及其他結構組件上面、裏面或表面的照明管道、消防、通風及其他服務、設施、裝置、固定裝置、輔助工程，設備及物料的通行權；
 - (ix) 於政府樓宇內、周圍、其範圍內、其上及其下的牆、圓柱、樑、天花、天台板、行車道或樓板及其他結構組件上或其任何部分改變及運行附加服務以專門服務或惠及政府樓宇的權利，及相關通行該土地或發展項目任何部分的權利，不論是否連同傭人、工人及其他人，及不論是否攜帶機械、設備、機器及物料，惟在進行上述改動工程時必須採取適當及足夠的預防措施，以確保不會對該土地內及服務除政府樓宇外發展項目的所有部分的該等服務及設施造成損壞；以及
 - (x) 署長視為必要或恰當的其他權利、特權及地役權。

- (b) 政府或財政司司長法團於任何時候更改政府樓宇或其任何部分之用途的權利，而無須取得港鐵、其他業主及管理人的批准或同意。
- (c) 行使任何上述第2(a)至(b)段的權利、特權及地役權無須港鐵、其他業主及管理人的任何許可、批准或同意。

5. 公共休憩空間

批地文件相關條文：

特別條款第(43)(a)-(c)條

- 「(a) 承批人須於2026年6月30日或C地盤到期日或經延展的到期日（如適用）起計96個月屆滿當日（以較後者為準）或之前自費搭建、建造及提供一個不小於1300平方米的地面公共休憩空間（下稱「公共休憩空間」）並使署長在各方面滿意。公共休憩空間須由承批人自費以署長要求的標準及使用署長要求的物料、設備及設施設置、平整、服務、美化、種植、處理及提供，使署長在各方面滿意。
- (b) 承批人須於整個在此協定的批租期內自費修理、保養、維修、管理公共休憩空間及其上之一切物件，並使署長在各方面滿意。就此特別條款而言，「承批人」一詞指商業樓宇（根據特別條款第(48)(b)條定義）業主。
- (c) 在不影響本特別條款第(b)分條的一般性下，承批人須於完成公共休憩空間工程後及整個在此協定的批租期內：
 - (i) 保持公共休憩空間每日24小時開放給公眾不受阻礙地使用及享受；及
 - (ii) 自費並使署長滿意地在顯眼處張貼告示通知公眾公共休憩空間開放予公眾使用，及列明其開放時間及其他署長不時要求的相關資料。」

公契相關條文：

主公契中「商業發展項目」的定義

「『商業發展項目』指按批地文件特別條款第(48)(b)條定義並於C地盤內按經批准圖則已建或擬建作商業及/或零售用的商業樓宇及其附屬地方，並為免生疑，包括公共休憩空間（按批地文件特別條款第(43)(a)條定義）、部分按批地文件特別條款第(59)(c)條提供的有蓋行人通道、供商業發展項目的佔用人及其真正賓客、訪客及受邀人使用的私家車及電單車停車位、劃定供商業發展項目使用的貨車上落貨車位及其相連車道及通道地方、所有位於商業發展項目內及其附屬的結構柱，並將於就C地盤訂立的副公契或分副公契中更詳細描述。」

主公契第二附表第II部分的第4(b)條

「受限於批地文件的條款及財政司司長法團作為政府樓宇業主於批地文件、主公契及任何副公契或分副公契或單邊契據下的權利、地役權及特權，所有公眾人士有權

- (b) 於每日24小時免費及不受阻礙地使用及享用按批地文件特別條款第(43)(a)條提供的公眾休憩空間；

惟公眾人士行使前述權利時不能影響或損害於批地文件、主公契及任何副公契或分副公契或單邊契據底下保留予財政司司長法團作為政府樓宇業主的權利、地役權及特權。」

6. 行人通道

批地文件相關條文：

特別條款第(59)(c)、(d)及(e)條

- 「(c) 承批人須於2026年6月30日或C地盤到期日或經延展的到期日（如適用）起計96個月屆滿當日（以較後者為準）或其他署長可能批准的日期或時限或之前自費及使署長在各方面滿意下在該地段內提供一條闊4米的有蓋行人通道，以連接黃竹坑站、政府樓宇、現有行人天橋、位於黃竹坑站下方的公共交通設施、沿南朗山道的公共巴士總站、沿警校道的公共小巴總站及未來行人天橋（其連接點於夾附於此的圖則Ia上之U3及V3點之間顯示及標記）。為免生疑問，署長可以其絕對酌情權准許沿南朗山道的公共巴士總站及沿警校道的公共小巴總站之間的部分行人通道搭建於署長可能決定的其他位置或以署長可能決定的其他闊度搭建。
- (d) 承批人須於整個在此協定的批租期內自費保養按本特別條款第(a)及(c)分條要求提供的隔離行人道或行人徑（連同該等樓梯、斜道、照明及升降機）及行人通道至良好及充足的維修狀態，以使署長滿意。
- (e) 承批人須於整個在此協定的批租期內保持此特別條款第(d)分條下提供的有蓋行人通道每日24小時不受阻礙地開放予公眾使用。」

公契相關條文：

主公契中「屋苑公用地方」的定義

「『屋苑公用地方』指屋苑中擬供多於一期數的業主而非任何一名業主、一群業主或某一期數的業主獨家使用的部分，包括但不限於設施坑道、未來行人天橋相關結構（按批地文件特別條款第(12)(b)條定義）、通道範圍、位於該土地以外的該部分行人連接通道（僅為管理及保養的目的而包含在此定義中）、部分按批地文件特別條款第(59)(c)條提供的有蓋行人通道（僅為管理及保養的目的而包含位於該土地以外的有蓋行人通道）、護牆、結構牆及柱、建於屋苑及服務多於一期數的建築物的地基及其他結構部分（但不包括構成車站或車廠一部分者）、屋苑公用道路、及所有其他位於屋苑內及並非供任何一名業主、一群業主或某一期數的業主獨家享用的公用地方（但不包括構成住宅發展項目公用地方或就某一期數訂立的副公契或分副公契或單邊契據中劃定或將劃定為某一期數的公用地方的地方）。屋苑公用地方將於就任何一期數訂立的副公契或分副公契或單邊契據附夾的圖則上更詳細標明。」

副公契中「第二期中的屋苑公用地方」及「第二期中的行人通道」的定義

「『第二期中的屋苑公用地方』指位於第二期內擬供予屋苑的業主而非任何一名業主、一群業主或某一期數的業主獨家使用的該部分屋苑公用地方，包括但不限於未來行人天橋相關結構（定義見批地文件特別條款第(12)(b)條）、第二期中的行人通道（僅為管理及保養的目的而包括已建或擬建毗鄰B地盤但位於該土地以外的該部分）、第二期綠化範圍的其中部分、花槽、消防員升降機大堂、暢通易達升降機、消防喉轆、電線槽、防火閘、走廊、樓梯及梯台、護牆、結構牆及柱、建於屋苑及服務多於一期數及位於B地盤以內的建築物的地基及其他結構部分（但不包括構成車站或車廠一部分者），但不包括第二期中的住宅發展項目公用地方、第二期公用地方、第二期住宅公用地方及第二期停車場公用地方；第二期中的屋苑公用地方在經認可人士核證為準確並附夾於副公契的圖則上為辨認用途以靛藍色、靛藍色加黑交叉線及靛藍色加黑交叉線和黑點顯示。」

「『第二期中的行人通道』指根據批地文件特別條款第(59)(c)條B地盤內已建或擬建的該部分行人通道及已建或擬建毗鄰B地盤但位於該土地以外的該部分行人通道（僅為管理及保養的目的而包括於此），並在經認可人士核證為準確並附夾於副公契的圖則上為辨認用途以靛藍色加黑交叉線及靛藍色加黑交叉線和黑點顯示。」

主公契第二附表第II部分的第2(b)條

「管理人有權帶同或不帶同測量師、工人及其他人士進行署長要求的必要工程臨時關閉建於該土地上的任何建築物（不包括政府樓宇）的任何出口，以便將行人通道、地下通道或行人天橋按批地文件特別條款第(12)條連接至建於該土地上的建築物、的未來行人天橋相關結構（按批地文件特別條款第(12)(b)條定義）或連接至行人連接通道及有蓋行人通道（於批地文件特別條款第(59)(c)條提述）、或按批地文件要求連接至建於該土地以外的其他構築物或建築物。管理人在進行上述工程時必須以書面通知業主其於工程進行期間不可使用該土地及發展項目的有關地方或部分，而業主必須遵守有關通知的要求，惟不得阻礙政府樓宇的出入及不得干擾政府樓宇的正當使用及享用。」

主公契第二附表第II部分的第4(c)條

「受限於批地文件的條文及財政司司長法團作為政府樓宇業主於批地文件、本主公契及任何副公契或分副公契或單邊契據下的權利、地役權及特權，所有公眾人士有權：

- (c) 於每天的24內免費及無阻礙地使用按批地文件特別條款第(59)(c)條提供的有蓋行人通道；

惟公眾人士行使前述權利時不能影響或損害於批地文件、本主公契及任何副公契或分副公契或單邊契據底下保留予財政司司長法團作為政府樓宇業主的權利、地役權及特權。」

副公契第二附表第II部分的第3(b)條

「在無損主公契第二附表第II部分第3條保留予港鐵之權利之一般性為前提下：

- (a) 港鐵具有權力帶同一切所需的工具、設備、機械及物料，帶同或不帶同傭工、工人或其他人，在一切合理時間之內，在給予事先書面通知後（緊急情況除外）進入B地盤的任何部分（港鐵已出售或轉讓的單位除外），以便按其所需不時在地盤B內的任何一點或部分以提供、興建及維修第二期內的行人通道，惟應盡量減低造成的滋擾及就其造成的任何損壞作出彌補。」

7. 通道範圍

批地文件相關條文：

特別條款第(61)(a)-(f)及(h)條

- 「(a) 除非事先獲得署長書面同意，除於本協議日期已存有的構築物外，不得在該地段中(i)在此夾附的圖則Ia上以粉紅色加橙點顯示之範圍（除非已預留由地面水平向上延伸5.5米高的淨空間作公眾行人通道之用）及(ii)在此夾附的圖則Ia上以粉紅色加棕斜線橙點顯示之範圍（除非已預留由地面水平向上延伸3.0米高的淨空間作公眾行人通道之用）內搭建或興建建築物或構築物或任何建築物或構築物的支撐物（該等在上述粉紅色加橙點範圍及粉紅色加棕斜線橙點範圍內的淨空間在下文合稱「通道範圍」）。
- (b) 承批人須於2027年6月30日或F地盤到期日或經延展的到期日（如適用）起計84個月屆滿當日（以較後者為準）或其他署長可能批准的日期或時限或之前自費及使署長在各方面滿意下以署長批准的方式、物料、標準、高度、定線及設計鋪設、平整、提供、建造、鋪設表面及美化通道範圍，包括安裝街燈、種植灌木及樹木及提供及建造其他署長可能要求的該等行人道或其他構築物，以使通道範圍可作公眾行人通道之用。
- (c) 在此特別條款第(b)分條提述的工程完成後，承批人須於整個在此協定的批租期內准許所有公眾人士於所有時間以步行或輪椅方式自由及毋須以任何方式付費地經過及再經過通道範圍以作一切合法用途。
- (d) 受限於此特別條款第(b)分條，承批人不得進行任何署長認為可能影響通道範圍的工程（署長之意見為最終並對承批人具約束力）。
- (e) 通道範圍不得用作公眾人士以步行或輪椅方式通行以外的任何其他用途。
- (f) 承批人須於整個在此協定的批租期內自費保養通道範圍至良好及充足的維修狀態，並保持其整潔，以使署長在各方面滿意。
- (h) 承批人須於整個在此協定的批租期內的所有時間准許政府及其人員、代理人、承辦商、工人或其他妥獲授權之人士有權帶同或不帶同工具、設備、裝置、機器或車輛進入、離開或再進入該地段或其任何一個或多個部分及在其上已建或將建的任何一幢或多幢建築物，以視察、檢查及監督任何由承批人按此特別條款第(b)及(f)分條下進行的工程及進行、視察、檢查及監督特別條款此特別條款第(g)分條下的工程。」

公契相關條文：

主公契中「屋苑公用地方」及「通道範圍」的定義

「『屋苑公用地方』指屋苑中擬供多於一期數的業主而非任何一名業主、一群業主或某一期數的業主獨家使用的部分，包括但不限於設施坑道、未來行人天橋相關結構（按批地文件特別條款第(12)(b)條定義）、通道範圍、位於該土地以外的該部分行人連接通道（僅為管理及保養的目的而包含在此定義中）、部分按批地文件特別條款第(59)(c)條提供的有蓋行人通道（僅為管理及

保養的目的而包含位於該土地以外的有蓋行人通道)、護牆、結構牆及柱、建於屋苑及服務多於一期數的建築物的地基及其他結構部分(但不包括構成車站或車廠一部分者)、屋苑公用道路、及所有其他位於屋苑內及並非供任何一名業主、一群業主或某一期數的業主獨家享用的公用地方(但不包括構成住宅發展項目公用地方或就某一期數訂立的副公契或分副公契或單邊契據中劃定或將劃定為某一期數的公用地方的地方)。屋苑公用地方將於就任何一期數訂立的副公契或分副公契或單邊契據附夾的圖則上更詳細標明。」

「『通道範圍』指批地文件特別條款第(61)(a)條所定義的通道範圍。」

主公契第二附表第II部分的4(d)條

「受限於批地文件的條文及財政司司長法團作為政府樓宇業主於批地文件、本主公契及任何副公契或分副公契或單邊契據下的權利、地役權及特權，所有公眾人士有權：

- (d) 於所有時間自由及免付任何性質的費用徒步或乘坐輪椅經過及再經過通道範圍作所有合法用途；

惟公眾人士行使前述權利時不能影響或損害於批地文件、本主公契及任何副公契或分副公契或單邊契據底下保留予財政司司長法團作為政府樓宇業主的權利、地役權及特權。」

B. 根據批地文件規定須由期數中的住宅物業的擁有人出資管理、營運或維持以供公眾使用的設施

1. 第一預留範圍內現有的服務設施及與鐵路相關的構築物

批地文件相關條文：

特別條款第(11)(a)及(b)條

- 「(a) 謹此確認承批人已於第一預留範圍內搭建現有的服務設施及與鐵路相關的構築物，承批人須自費保養、維修及更換現有的服務設施及與鐵路相關的構築物以使署長在各方面滿意。
- (b) 在批租期完結時及署長要求下，承批人須自費及在署長以書面指明的時間內拆卸及移除此特別條款第(a)分條指明的所有現有的服務設施及與鐵路相關的構築物。」

公契相關條文：

主公契E章第8(b)條

「港鐵作為車站及車廠的業主須自費並在署長各方面滿意下按批地文件特別條款第(11)(a)保養、維修及更換位於第一預留範圍(按批地文件特別條款第(10)(a)條定義)內現有的設施及與鐵路相關的構築物。」

2. 未來行人天橋相關結構

批地文件相關條文：

特別條款第(12)(a)、(b)、(e)、(f)及(g)條

- 「(a) 承批人於本協議日期已自費在該地段內搭建、提供及興建支柱及其他結構性支撐物及接駁位(該等支柱及其他結構性支撐物及接駁位在下文合稱「行人天橋相關結構」)，用以連接該地段至於在此夾附的圖則Ia上U1及V1兩點之間標示的位置擁有最少3.0米內部淨闊度、最少2.4米內部通行高度及由香港主水平基準以上11.7米至香港主水平基準以上18.6米之間的最少淨空高度並在此夾附的圖則Ia上以“EW”標示之現有行人天橋(下稱「現有行人天橋」)。此後承批人須自費管理及保養行人天橋相關結構，以使署長在各方面滿意。
- (b) 承批人須於2026年6月30日或C地盤到期日或經延展的到期日(如適用)起計96個月屆滿當日(以較後者為準)或其他署長可能批准的日期或時限或之前自費及使署長在各方面滿意下在該地段內以署長要求或批准的物料、標準、高度、定線、布局及設計搭建、提供及建造署長可能要求的支柱及其他結構性支撐物及接駁位(該等支柱及其他結構性支撐物及接駁位在下文合稱「未來行人天橋相關結構」)，並在此後自費管理及保養未來行人天橋相關結構，以連接該地段至可能位於在此夾附的圖則Ia上U3及V3兩點之間標示的位置或位於或經過其他由署長書面批准的位置或點，並擁有全由署長決定的最少內部淨闊度、最少內部通行高度及何等水平之間的最少淨空高度之未來行人天橋。為免生疑問，就未來行人天橋會否建成並無保證。
- (e) 於整個在此協定的批租期內，政府及其人員、承辦商、代理人、工人、僱員及其他正式獲授權人士有權帶同或不帶同工具、設備、裝置、機器或車輛毋須成本、費用及開支在所有時間進入或經過該地段或其任何一個或多個部分之內、之上或進入或經過在其上搭建的任何一幢或多幢建築物之內、下、上或之上：
- (i) 以進行以連接未來行人天橋至未來行人天橋相關結構為目的之工程(該等連接工程在下稱「連接工程」)並在此後享有連接工程、現有行人天橋及未來行人天橋的支撐地役權；及
- (ii) 以維修及保養連接工程、現有行人天橋及未來行人天橋。
- 政府及其人員、承辦商、代理人、工人及僱員毋須就因行使其根據本分條授予之權力引起或相關而令承批人蒙受的任何損失、損害、滋擾或侵擾承擔任何法律責任，而承批人亦不得就任何該等損失、損害、滋擾或侵擾向其索償。
- (f) 當署長要求時，承批人須自費及在署長各方面滿意下進行所有署長要求或批准的工程臨時封閉在該地段上已建或擬建的一幢或多幢建築物的出入口，以連接現有行人天橋及未來行人天橋。臨時封閉處的所有必需的保養工程須由承批人負責，並由其自費展開以使署長滿意。
- (g) 承批人已在本協議日期提供並須於整個在此協定的批租期內自費並在署長各方面滿意下保持一條開放予公眾免費及無阻礙地使用的公眾行人通道，以在特別條款第(46)(a)條定義的黃竹坑站的營運時間內連接在此夾附的圖則Ia上U1及V1兩點之間標示的位置的現有行人天橋及在此夾附的圖則Ia上從U2至V2各點之間標示的位置的地面水平。」

公契相關條文：

主公契中「屋苑公用地方」及「車站」的定義

「『屋苑公用地方』指屋苑中擬供多於一期數的業主而非任何一名業主、一群業主或某一期數的業主獨家使用的部分，包括但不限於設施坑道、未來行人天橋相關結構（按批地文件特別條款第(12)(b)條定義）、通道範圍、位於該土地以外的該部分行人連接通道（僅為管理及保養的目的而包含在此定義中）、部分按批地文件特別條款第(59)(c)條提供的有蓋行人通道（僅為管理及保養的目的而包含位於該土地以外的有蓋行人通道）、護牆、結構牆及柱、建於屋苑及服務多於一期數的建築物的地基及其他結構部分（但不包括構成車站或車廠一部分者）、屋苑公用道路、及所有其他位於屋苑內及並非供任何一名業主、一群業主或某一期數的業主獨家享用的公用地方（但不包括構成住宅發展項目公用地方或就某一期數訂立的副公契或分副公契或單邊契據中劃定或將劃定為某一期數的公用地方的地方）。屋苑公用地方將於就任何一期數訂立的副公契或分副公契或單邊契據附夾的圖則上更詳細標明。」

「『車站』指 (i) 建於該土地的黄竹坑站地盤（按批地文件特別條款第(1)(h)條定義）上或內的黄竹坑站（按批地文件特別條款第(46)(a)條定義），包括一個鐵路車站及附屬鐵路構築物、設施及道路、(ii) 批地文件特別條款第(70)條提述為黄竹坑站的營運需要而於黄竹坑站地盤內提供或將提供予汽車停泊、調動及上落客貨的停車位及(iii) 行人天橋相關結構（按批地文件特別條款第(12)(a)條定義）；為免生疑，以下並不構成車站的一部分：所有服務車廠或屋苑或其任何部分的公用事業、服務、槽、井及設施及車廠及屋苑的所有裝飾物料。」

副公契中「第二期中的屋苑公用地方」的定義

「『第二期中的屋苑公用地方』指位於第二期內擬供予屋苑的業主而非任何一名業主、一群業主或某一期數的業主獨家使用的該部分屋苑公用地方，包括但不限於未來行人天橋相關結構（定義見批地文件特別條款第(12)(b)條）、第二期中的行人通道（僅為管理及保養的目的而包括已建或擬建毗鄰B地盤但位於該土地以外的該部分）、第二期綠化範圍的其中部分、花槽、消防員升降機大堂、暢通易達升降機、消防喉轆、電線槽、防火閘、走廊、樓梯及梯台、護牆、結構牆及柱、建於屋苑及服務多於一期數及位於B地盤以內的建築物的地基及其他結構部分（但不包括構成車站或車廠一部分者），但不包括第二期中的住宅發展項目公用地方、第二期公用地方、第二期住宅公用地方及第二期停車場公用地方；第二期中的屋苑公用地方在經認可人士核證為準確並附夾於副公契的圖則上為辨認用途以靛藍色、靛藍色加黑交叉線及靛藍色加黑交叉線和黑點顯示。」

主公契E章第8(c)條

「港鐵作為車站及車廠的業主須自費負責提供及保持批地文件特別條款第(12)(g)條所要求的公眾行人通道，並於黄竹坑站（按批地文件特別條款第(46)(a)條定義）營運時間內開放予公眾免費及無阻礙地使用，以使署長各方面滿意。」

主公契第二附表第II部分的第2(b)條

「管理人有權帶同或不帶同測量師、工人及其他人士進行署長要求的必要工程臨時關閉建於該土地上的任何建築物（不包括政府樓宇）的任何出口，以便將行人通道、地下通道或行人天橋按批地文件特別條款第(12)條連接至建於該土地上的建築物、的未來行人天橋相關結構（按批地文件特別條款第(12)(b)條定義）或連接至行人連接通道及有蓋行人通道（於批地文件特別條

款第(59)(c)條提述）、或按批地文件要求連接至建於該土地以外的其他構築物或建築物。管理人在進行上述工程時必須以書面通知業主其於工程進行期間不可使用該土地及發展項目的有關地方或部分，而業主必須遵守有關通知的要求，惟不得阻礙政府樓宇的出入及不得干擾政府樓宇的正當使用及享用。」

主公契第二附表第II部分的第4(a)條

「受限於批地文件的條文及財政司司長法團作為政府樓宇業主於批地文件、本主公契及任何副公契或分副公契或單邊契據下的權利、地役權及特權，所有公眾人士有權：

- (a) 於按批地文件特別條款第(46)(a)條定義的黄竹坑站的營運時間內使用港鐵按批地文件特別條款第(12)(g)條提供的行人通道；

惟公眾人士行使前述權利時不能影響或損害於批地文件、本主公契及任何副公契或分副公契或單邊契據底下保留予財政司司長法團作為政府樓宇業主的權利、地役權及特權。」

副公契第二附表第II部分的第3(a)條

「在無損主公契第二附表第II部分第3條保留予港鐵之權利之一般性為前提下：

- (a) 港鐵具有權力帶同一切所需的工具、設備、機械及物料，帶同或不帶同傭工、工人或其他人，在一切合理時間之內，在給予事先書面通知後（緊急情況除外）進入B地盤的任何部分（港鐵已出售或轉讓的單位除外），以便按其所需不時在地盤B內的任何一點或部分豎立、提供及興建行人天橋、柱、結構支撐及連接，包括但不限於未來行人天橋相關結構（按批地文件特別條款第12(b)條定義），惟應盡量減低造成的滋擾及就其造成的任何損壞作出彌補。」

3. 綠色範圍及該等構築物

批地文件相關條文：

特別條款第(13)(a)條

「(a) 承批人須：

- (i) 於2026年3月31日或D地盤到期日或經延展的到期日（如適用）起計84個月屆滿當日（以較後者為準）或其他署長可能批准的日期或時限或之前自費並按署長批准的方式、物料、標準、水平、定線和設計並使署長在各方面滿意下：
 - (I) 在此所夾附的圖則1a上以綠色顯示的部份（下稱「綠色範圍」）鋪設及平整部份未來公共道路；及
 - (II) 提供及建造該等橋樑、隧道、上跨路、下通道、下水道、高架管道、天橋、行人道、道路或署長以其酌情要求的其他構築物（在下文合稱「該等構築物」）使建築、車輛、行人的交通得以在綠色範圍內往來；
- (ii) 於2026年3月31日或D地盤到期日或經延展的到期日（如適用）起計84個月屆滿當日（以較後者為準）或其他署長可能批准的日期或時限或之前自費在綠色範圍

鋪設路面、建造路緣及渠道，並提供署長規定的溝渠、污水渠、排水渠、消防栓連接駁至總水管的水管、服務設施、街燈、交通標誌、街道設施、路面標記及植物，以使署長滿意；及

- (iii) 自費保養綠色範圍連同該等構築物及在其上或其內建造、安裝及提供的所有構築物、路面、溝渠、污水渠、排水渠、消防栓、服務設施、街燈、交通標誌、街道設施、路面標記和植物以使署長滿意，直至綠色範圍的管有權根據特別條款第(14)條交還為止。」

特別條款第(14)條

「僅為了進行特別條款第(13)條指明的所需工程，綠色範圍的管有權將會在本協議日期當日授予承批人。綠色範圍須於要求時交還予政府，並在任何情況下於署長發信表明此等條款以獲符合並使其滿意之日視為已交還予政府。承批人須在其管有綠色範圍的所有合理時間內准許所有政府及公共車輛及行人自由進入及通過綠色範圍，並確保該項進入的權利不受進行的工程干擾或阻礙，不論有關工程是否依據特別條款第(13)條進行。」

特別條款第(15)條

「在未獲署長事先書面同意之前，承批人不得使用綠色範圍作儲存用途或作搭建任何臨時構築物或作任何進行特別條款第(13)條指明之工程以外之任何用途。」

特別條款第(16)條

「承批人須在其管有綠色範圍期間的所有合理時間內准許政府、署長及其人員、承辦商及代理人及任何獲其授權之人士有權進入、離開及再進入該地段及綠色範圍，以視察、檢查及監督任何為遵從特別條款第(13)(a)條而進行的工程及進行、視察、檢查及監督特別條款第(13)(b)條下的工程及任何其他在綠色範圍內署長認為需要的工程。」

公契相關條文：

主公契中「綠色範圍」及「該等構築物」的定義

「『綠色範圍』指該部分按批地文件特別條款第(13)(a)(i)(I)條由港鐵於批地文件附夾的圖則Ia上以綠色顯示的範圍鋪設及平整的公共道路及擬鋪設及平整的未來公共道路。」

「『該等構築物』指按批地文件特別條款第(13)(a)(i)(II)條定義的該等構築物。」

主公契E章第1(b)條

「為免生疑，受限於批地文件及本主公契的條文，港鐵作為批地文件下該土地的原始承批人進行綠色範圍、該等構築物、綠色圓點範圍及綠色圓點範圍構築物的興建，並承擔有關建築成本，在港鐵完成興建綠色範圍、該等構築物、綠色圓點範圍及綠色圓點範圍構築物或其任何一部分而使署長滿意時，綠色範圍、該等構築物、綠色圓點範圍及綠色圓點範圍構築物或其任何已落成的部分將由管理人根據本主公契管理及控制，直至交還予政府為止。」

主公契F章第1條

「受限於本章第12條，應按情況需要不時舉行屋苑業主的會議，以討論及決議以下所述與屋苑及/或（按批地文件交還予政府前）綠色範圍、該等構築物、綠色圓點範圍及綠色圓點範圍構築物相關的事宜，而本章的條文適用於有關會議。屋苑業主會議的程序將由屋苑的業主決定。」

主公契F章第9(a)條

「在正式召開的會議上由親自出席會議的業主或投票代表投票，並以過半數票通過的任何有關屋苑及/或綠色範圍、該等構築物、綠色圓點範圍及綠色圓點範圍構築物相關的決議對所有業主具約束力（於本章第11條提述的事項除外），但是：

- (i) 會議通知必須正式發出並列明擬通過有關事項的議案；
- (ii) 擬在任何該等會議上通過但未有在該會議通知中列明的任何事項之決議均無效；
- (iii) 除非本主公契另有指明，凡擬更改、修訂及抵觸本主公契的決議一概無效；
- (iv) 與香港法院的任何命令、裁決或判決或任何法例的任何強制性條款抵觸或相反的決議一概無效；
- (v) 任何決議均不得影響政府樓宇或其任何部分的使用、操作或保養，或供政府樓宇使用的服務及設施；
- (vi) 任何在港鐵的合理意見下認為可能影響地下鐵路、地下鐵路構築物及裝置、車站或車廠或其任何部分的決議，須受限於港鐵的同意；
- (vii) 任何決議均不得破壞、干擾、阻礙或危害地下鐵路、地下鐵路構築物及裝置、車站或車廠或其任何部分的建造、使用、操作、保養或安全。」

主公契G章第1(b)(ii)條

「發展項目業主委員會的職能為：

- (ii) 討論與維修及管理屋苑公用地方、屋苑公用服務及設施、住宅發展項目公用地方、住宅發展項目公用服務及設施、綠色範圍、該等構築物、綠色圓點範圍及綠色圓點範圍構築物相關的事宜並將其意見告知管理人；」

主公契I章第1(a)條

「受限於該條例的條文，及受限於財政司司長法團作為政府樓宇業主於本主公契、任何副公契或分副公契或單邊契據及批地文件下的權利、地役權及特權，就屋苑中任何已按本主公契訂立副公契的部分（政府樓宇除外）及（按批地文件交還予政府前）綠色範圍、該等構築物、綠色圓點範圍及綠色圓點範圍構築物，管理人有權按本主公契的條文代表所有業主（財政司司長法團作為政府樓宇業主除外）作出任何為管理該土地及屋苑的相關部分（政府樓宇除外）及綠色範圍、該等構築物、綠色圓點範圍及綠色圓點範圍構築物而必要或適宜的行動及事宜及任何與其合理地相關的事宜，而每一位業主（財政司司長法團作為政府樓宇業主除外）不可撤銷地委任管理人作為有關任何涉及公用地方及公用服務或設施及其於本主公契或任何副公契或分副公契下受獲授權之所有其他事宜的代理人。」

主公契I章第2條

「受限於該條例及本主公契的條文，公用地方、公用服務及設施及（按批地文件交還予政府前）綠色範圍、該等構築物、綠色圓點範圍及綠色圓點範圍構築物將由管理人獨自控制。」

主公契I章第4(b)條

「管理人或（如無管理人）業主立案法團或發展項目業主委員會的主席有權代表該土地的所有業主接受政府就交付綠色範圍、該等構築物、綠色圓點範圍及/或綠色圓點範圍構築物或其任何部分的管有權送達的通知或要求及按批地文件交付綠色範圍、該等構築物、綠色圓點範圍及/或綠色圓點範圍構築物或其任何部分予政府。」

主公契J章第5(b)(II)條

「即使本主公契有另有規定，車站及車廠的業主須分擔(i)屋苑公用地方及設施管理副預算案的成本及支出，但僅限於因綠色範圍、該等構築物、綠色圓點範圍、綠色圓點範圍構築物及通道範圍而非其他部分的保養及管理引致的成本及支出，及(ii)有關綠色範圍、該等構築物、綠色圓點範圍、綠色圓點範圍構築物及通道範圍而非其他部分的資本性質的主要工程或並非預期每年支出的開支，並作出供款，計算基準為車站及車廠的建築樓面總面積佔車站及車廠的建築樓面總面積加屋苑所有當時已落成部分的建築樓面總面積（「已落成的屋苑建築樓面總面積」）的比例。管理人須於屋苑公用地方及設施管理副預算案下準備分副預算案，以顯示來年就綠色範圍、該等構築物、綠色圓點範圍、綠色圓點範圍構築物及通道範圍的保養及管理的預計年度成本及支出，及就綠色範圍、該等構築物、綠色圓點範圍、綠色圓點範圍構築物及通道範圍的資本性質的主要工程或並非預期每年支出的該等開支，並將一份分副預算案的副本送遞予車站及車廠的業主供其參考。就本分條而言，車站及車廠的建築樓面總面積為53,726平方米，而「已落成的屋苑總建築樓面面積」指經屋苑或相關期數的認可人士核證的屋苑已落成部分的實際樓面總面積，不論該樓面總面積於《建築物條例》或批地文件下是否計入樓面總面積。」

4. 綠色圓點範圍及綠色圓點範圍構築物

批地文件相關條文：

特別條款第(17)(a)條

「(a) 承批人須：

- (i) 於2026年6月30日或C地盤到期日或經延展的到期日（如適用）起計96個月屆滿當日（以較後者為準）或其他署長可能批准的日期或時限或之前自費並按署長批准的方式、物料、標準、水平、定線和設計並使署長在各方面滿意下：

- (I) 鋪設及平整位於在此夾附的圖則Ia上以綠色圓點顯示之範圍（下稱「綠色圓點範圍」）內一個或多個地面層以下2米至一個或多個地面層以上5.5米之間的空氣層內的部分未來公共道路。為免生疑問，綠色圓點範圍的空氣層與第五預留範圍相同；及

- (II) 提供及建造該等橋樑、隧道、上跨路、下通道、下水道、高架管道、天橋、行人道、道路或署長以其酌情要求的其他構築物（在下文合稱「綠色圓點範圍構築物」）使建築、車輛、行人的交通得以在綠色圓點範圍內往來；

- (ii) 於2026年6月30日或C地盤到期日或經延展的到期日（如適用）起計96個月屆滿當日（以較後者為準）或其他署長可能批准的日期或時限或之前自費在綠色圓點範圍鋪設路面、建造路緣及渠道，並提供署長規定的溝渠、污水渠、排水渠、消防栓連接駁至總水管的水管、服務設施、街燈、交通標誌、街道設施、路面標記及植物，以使署長滿意；及

- (iii) 自費保養綠色圓點範圍連同綠色圓點範圍構築物及在其上或其內建造、安裝及提供的所有構築物、路面、溝渠、污水渠、排水渠、消防栓、服務設施、街燈、交通標誌、街道設施、路面標記和植物以使署長滿意，直至綠色圓點範圍的管有權根據特別條款第(18)條交還為止。」

特別條款第(18)條

「僅為了進行特別條款第(17)條指明的所需工程，綠色圓點範圍的管有權將會在本協議日期當日授予承批人。綠色圓點範圍須於要求時交還予政府，並在任何情況下於署長發信表明此等條款以獲符合並使其滿意之日視為已交還予政府。承批人須在其管有綠色圓點範圍的所有合理時間內准許所有政府及公共車輛及行人自由進入及通過綠色圓點範圍，並確保該項進入的權利不受進行的工程干擾或阻礙，不論有關工程是否依據特別條款第(17)條進行。」

特別條款第(19)條

「在未獲署長事先書面同意之前，承批人不得使用綠色圓點範圍作儲存用途或作搭建任何臨時構築物或作任何進行特別條款第(17)條指明之工程以外之任何用途。」

特別條款第(20)條

「承批人須在其管有綠色圓點範圍期間的所有合理時間內准許政府、署長及其人員、承辦商及代理人及任何獲其授權之人士有權進入、離開及再進入該地段及綠色圓點範圍，以視察、檢查及監督任何為遵從特別條款第(17)(a)條而進行的工程及進行、視察、檢查及監督特別條款第(17)(b)條下的工程及任何其他在綠色圓點範圍內署長認為需要的工程。」

公契相關條文：

主公契中「綠色圓點範圍」及「綠色圓點範圍構築物」的定義

「『綠色圓點範圍』指該部分按批地文件特別條款第(17)(a)(i)(I)條由港鐵於批地文件附夾的圖則Ia上以綠色圓點顯示之範圍內的地面層以下2米至地面層以上5.5米之間的空氣層內鋪設及平整的公共道路及擬鋪設及興建的未來公共道路。」

「『綠色圓點範圍構築物』指按批地文件特別條款第(17)(a)(i)(II)條定義的綠色圓點範圍構築物。」

主公契E章第1(b)條

「為免生疑，受限於批地文件及本主公契的條文，港鐵作為批地文件下該土地的原始承批人進行綠色範圍、該等構築物、綠色圓點範圍及綠色圓點範圍構築物的興建，並承擔有關建築成本，在港鐵完成興建綠色範圍、該等構築物、綠色圓點範圍及綠色圓點範圍構築物或其任何一部分而使署長滿意時，綠色範圍、該等構築物、綠色圓點範圍及綠色圓點範圍構築物或其任何已落成的部分將由管理人根據本主公契管理及控制，直至交還予政府為止。」

主公契F章第1條

「受限於本章第12條，應按情況需要不時舉行屋苑業主的會議，以討論及決議以下所述與屋苑及/或（按批地文件交還予政府前）綠色範圍、該等構築物、綠色圓點範圍及綠色圓點範圍構築物相關的事宜，而本章的條文適用於有關會議。屋苑業主會議的程序將由屋苑的業主決定。」

主公契F章第9(a)條

「在正式召開的會議上由親自出席會議的業主或投票代表投票，並以過半數票通過的任何有關屋苑及/或綠色範圍、該等構築物、綠色圓點範圍及綠色圓點範圍構築物相關的決議對所有業主具約束力（於本章第11條提述的事項除外），但是：

- (i) 會議通知必須正式發出並列明擬通過有關事項的議案；
- (ii) 擬在任何該等會議上通過但未有在該會議通知中列明的任何事項之決議均無效；
- (iii) 除非本主公契另有指明，凡擬更改、修訂及抵觸本主公契的決議一概無效；
- (iv) 與香港法院的任何命令、裁決或判決或任何法例的任何強制性條款抵觸或相反的決議一概無效；
- (v) 任何決議均不得影響政府樓宇或其任何部分的使用、操作或保養，或供政府樓宇使用的服務及設施；
- (vi) 任何在港鐵的合理意見下認為可能影響地下鐵路、地下鐵路構築物及裝置、車站或車廠或其任何部分的決議，須受限於港鐵的同意；
- (vii) 任何決議均不得破壞、干擾、阻礙或危害地下鐵路、地下鐵路構築物及裝置、車站或車廠或其任何部分的建造、使用、操作、保養或安全。」

主公契G章第1(b)(ii)條

「發展項目業主委員會的職能為：

- (ii) 討論與維修及管理屋苑公用地方、屋苑公用服務及設施、住宅發展項目公用地方、住宅發展項目公用服務及設施、綠色範圍、該等構築物、綠色圓點範圍及綠色圓點範圍構築物相關的事宜並將其意見告知管理人；」

主公契I章第1(a)條

「受限於該條例的條文，及受限於財政司司長法團作為政府樓宇業主於本主公契、任何副公契或分副公契或單邊契據及批地文件下的權利、地役權及特權，就屋苑中任何已按本主公契訂立副公契的部分（政府樓宇除外）及（按批地文件交還予政府前）綠色範圍、該等構築物、綠色

圓點範圍及綠色圓點範圍構築物，管理人有權按本主公契的條文代表所有業主（財政司司長法團作為政府樓宇業主除外）作出任何為管理該土地及屋苑的相關部分（政府樓宇除外）及綠色範圍、該等構築物、綠色圓點範圍及綠色圓點範圍構築物而必要或適宜的行動及事宜及任何與其合理地相關的事宜，而每一位業主（財政司司長法團作為政府樓宇業主除外）不可撤銷地委任管理人作為有關任何涉及公用地方及公用服務或設施及其於本主公契或任何副公契或分副公契下妥獲授權之所有其他事宜的代理人。」

主公契I章第2條

「受限於該條例及本主公契的條文，公用地方、公用服務及設施及（按批地文件交還予政府前）綠色範圍、該等構築物、綠色圓點範圍及綠色圓點範圍構築物將由管理人獨自控制。」

主公契I章第4(b)條

「管理人或（如無管理人）業主立法法團或發展項目業主委員會的主席有權代表該土地的所有業主接受政府就交付綠色範圍、該等構築物、綠色圓點範圍及/或綠色圓點範圍構築物或其任何部分的管有權送達的通知或要求及按批地文件交付綠色範圍、該等構築物、綠色圓點範圍及/或綠色圓點範圍構築物或其任何部分予政府。」

主公契J章第5(b)(II)條

「即使本主公契有另有規定，車站及車廠的業主須分擔(i)屋苑公用地方及設施管理副預算案的成本及支出，但僅限於因綠色範圍、該等構築物、綠色圓點範圍、綠色圓點範圍構築物及通道範圍而非其他部分的保養及管理引致的成本及支出，及(ii)有關綠色範圍、該等構築物、綠色圓點範圍、綠色圓點範圍構築物及通道範圍而非其他部分的資本性質的主要工程或並非預期每年支出的開支，並作出供款，計算基準為車站及車廠的建築樓面總面積佔車站及車廠的建築樓面總面積加屋苑所有當時已落成部分的建築樓面總面積（「已落成的屋苑建築樓面總面積」）的比例。管理人須於屋苑公用地方及設施管理副預算案下準備分副預算案，以顯示來年就綠色範圍、該等構築物、綠色圓點範圍、綠色圓點範圍構築物及通道範圍的保養及管理的預計年度成本及支出，及就綠色範圍、該等構築物、綠色圓點範圍、綠色圓點範圍構築物及通道範圍的資本性質的主要工程或並非預期每年支出的該等開支，並將一份分副預算案的副本送遞予車站及車廠的業主供其參考。就本分條而言，車站及車廠的建築樓面總面積為53,726平方米，而「已落成的屋苑總建築樓面面積」指經屋苑或相關期數的認可人士核證的屋苑已落成部分的實際樓面總面積，不論該樓面總面積於《建築物條例》或批地文件下是否計入樓面總面積。」

5. 物件

批地文件相關條文：

特別條款第(42)(a)、(b)及(c)條

- (a) 受限於特別條款第(64)(a)(iv)(I)條提述由財政司司長法團作出的任何供款，承批人須於整個在此協定的批租期內自費保養以下物件（下稱「物件」）使署長在各方面滿意：
 - (i) 政府樓宇的外部裝修物料及政府樓宇的及其中、周圍、其內、其上及其下的一切牆壁、支柱、橫樑、天花板、天台樓板、行車道或樓板的結構及任何其他結構件；

- (ii) 服務政府樓宇和該地段的發展項目餘下部分的所有升降機、扶手電梯及樓梯；
 - (iii) 構成服務政府樓宇和該地段的發展項目餘下部分之系統一部分的所有屋宇裝備裝置、機械及設備（包括但不限於攜帶式和固定消防裝置設備）；及
 - (iv) 服務政府樓宇和該地段的發展項目餘下部分的所有其他公用部分及設施。
- (b) 承批人須就所有因其未有保養物件而引致或導致任何性質的責任、賠償、開支、申索、成本、索償、費用、法律行動及程序彌償政府及財政司司長法團，並保證他們獲得彌償。
- (c) 就此特別條款而言，「承批人」一詞不包括財政司司長法團。」

公契相關條文：

主公契中「物件」的定義

「『物件』指 (i) 政府樓宇的外部裝修物料及政府樓宇的及其中、周圍、其內、其上及其下的一切牆壁、支柱、橫樑、天花板、天台樓板、行車道或樓板及任何其他結構件；(ii) 服務政府樓宇和發展項目餘下部分的所有升降機、扶手電梯及樓梯；(iii) 構成服務政府樓宇和發展項目餘下部分之系統一部分的所有屋宇裝備裝置、機械及設備（包括但不限於攜帶式和固定消防裝置設備）；及(iv) 批地文件特別條款第(42)(a)條提述服務政府樓宇和發展項目餘下部分的所有其他公用部分及設施。」

主公契C章第5條

「共用牆須由該共用牆所分隔的單位的業主共同出資維修及保養，惟若共用牆的任何部分構成物件的一部分，共用牆的該部分則按本主主契E章第9(b)條由A地盤的單位的業主（政府樓宇業主除外）保養。」

主公契E章第9(b)條

「A地盤的單位的業主（政府樓宇業主除外）須通過管理人負責保養、管理及維修物件（受限於財政司司長法團按本條第(a)分條作出的任何供款）及須就因其未有如前述保養、管理及維修物件而招致或構成的任何人身或財產損失或損害所招致或有關的所有訴訟、法律程序、申索及索償彌償財政司司長法團及政府。」

主公契I章第(1)(b)(xii)條

「在毋損前文的一般性下，管理人擁有以下權利及職責：

- (xii) 受限於本主公契E章第9(b)條，保養、管理及保持物件至維修充足及良好的狀態。」

6. 行人通道

批地文件相關條文：

特別條款第(59)(c)、(d)及(e)條

- 「(c) 承批人須於2026年6月30日或C地盤到期日或經延展的到期日（如適用）起計96個月屆滿當日（以較後者為準）或其他署長可能批准的日期或時限或之前自費及使署長在各方面滿意下在該地段內提供一條闊4米的有蓋行人通道，以連接黃竹坑站、政府樓宇、現有行人天橋、位於黃竹坑站下方的公共交通設施、沿南朗山道的公共巴士總站、沿警校道的公共小巴總站及未來行人天橋（其連接點於夾附於此的圖則Ia上之U3及V3點之間顯示及標記）。為免生疑問，署長可以其絕對酌情權准許沿南朗山道的公共巴士總站及沿警校道的公共小巴總站之間的部分行人通道搭建於署長可能決定的其他位置或以署長可能決定的其他闊度搭建。
- (d) 承批人須於整個在此協定的批租期內自費保養按本特別條款第(a)及(c)分條要求提供的隔離行人道或行人徑（連同該等樓梯、斜道、照明及升降機）及行人通道至良好及充足的維修狀態，以使署長滿意。
- (e) 承批人須於整個在此協定的批租期內保持此特別條款第(d)分條下提供的有蓋行人通道每日24小時不受阻礙地開放予公眾使用。」

公契相關條文：

主公契中「屋苑公用地方」的定義

「『屋苑公用地方』指屋苑中擬供多於一期數的業主而非任何一名業主、一群業主或某一期數的業主獨家使用的部分，包括但不限於設施坑道、未來行人天橋相關結構（按批地文件特別條款第(12)(b)條定義）、通道範圍、位於該土地以外的該部分行人連接通道（僅為管理及保養的目的而包含在此定義中）、部分按批地文件特別條款第(59)(c)條提供的有蓋行人通道（僅為管理及保養的目的而包含位於該土地以外的有蓋行人通道）、護牆、結構牆及柱、建於屋苑及服務多於一期數的建築物的地基及其他結構部分（但不包括構成車站或車廠一部分者）、屋苑公用道路、及所有其他位於屋苑內及並非供任何一名業主、一群業主或某一期數的業主獨家享用的公用地方（但不包括構成住宅發展項目公用地方或就某一期數訂立的副公契或分副公契或單邊契據中劃定或將劃定為某一期數的公用地方的地方）。屋苑公用地方將於就任何一期數訂立的副公契或分副公契或單邊契據附夾的圖則上更詳細標明。」

副公契中「第二期中的屋苑公用地方」及「第二期中的行人通道」的定義

「『第二期中的屋苑公用地方』指位於第二期內擬供予屋苑的業主而非任何一名業主、一群業主或某一期數的業主獨家使用的該部分屋苑公用地方，包括但不限於未來行人天橋相關結構（定義見批地文件特別條款第(12)(b)條）、第二期中的行人通道（僅為管理及保養的目的而包括已建或擬建毗鄰B地盤但位於該土地以外的該部分）、第二期綠化範圍的其中部分、花槽、消防員升降機大堂、暢通易達升降機、消防喉轆、電線槽、防火閘、走廊、樓梯及梯台、護牆、結構牆及柱、建於屋苑及服務多於一期數及位於B地盤以內的建築物的地基及其他結構部分（但不包括構成車站或車廠一部分者），但不包括第二期中的住宅發展項目公用地方、第二期公用

地方、第二期住宅公用地方及第二期停車場公用地方；第二期中的屋苑公用地方在經認可人士核證為準確並附夾於副公契的圖則上為辨認用途以靛藍色、靛藍色加黑交叉線及靛藍色加黑交叉線和黑點顯示。」

「『第二期中的行人通道』指根據批地文件特別條款第(59)(c)條B地盤內已建或擬建的該部分行人通道及已建或擬建毗鄰B地盤但位於該土地以外的該部分行人通道（僅為管理及保養的目的而包括於此），並在經認可人士核證為準確並附夾於副公契的圖則上為辨認用途以靛藍色加黑交叉線及靛藍色加黑交叉線和黑點顯示。」

主公契第二附表第II部分的第2(b)條

「管理人有權帶同或不帶同測量師、工人及其他人士進行署長要求的必要工程臨時關閉建於該土地上的任何建築物（不包括政府樓宇）的任何出口，以便將行人通道、地下通道或行人天橋按批地文件特別條款第(12)條連接至建於該土地上的建築物、的未來行人天橋相關結構（按批地文件特別條款第(12)(b)條定義）或連接至行人連接通道及有蓋行人通道（於批地文件特別條款第(59)(c)條提述）、或按批地文件要求連接至建於該土地以外的其他構築物或建築物。管理人在進行上述工程時必須以書面通知業主其於工程進行期間不可使用該土地及發展項目的有關地方或部分，而業主必須遵守有關通知的要求，惟不得阻礙政府樓宇的出入及不得干擾政府樓宇的正當使用及享用。」

主公契第二附表第II部分的第4(c)條

「受限於批地文件的條文及財政司司長法團作為政府樓宇業主於批地文件、本主公契及任何副公契或分副公契或單邊契據下的權利、地役權及特權，所有公眾人士有權：

- (c) 於每天的24內免費及無阻礙地使用按批地文件特別條款第(59)(c)條提供的有蓋行人通道；

惟公眾人士行使前述權利時不能影響或損害於批地文件、本主公契及任何副公契或分副公契或單邊契據底下保留予財政司司長法團作為政府樓宇業主的權利、地役權及特權。」

副公契第二附表第II部分的第3(b)條

「在無損主公契第二附表第II部分第3條保留予港鐵之權利之一般性為前提下：

- (a) 港鐵具有權力帶同一切所需的工具、設備、機械及物料，帶同或不帶同傭工、工人或其他人，在一切合理時間之內，在給予事先書面通知後（緊急情況除外）進入B地盤的任何部分（港鐵已出售或轉讓的單位除外），以便按其所需不時在地盤B內的任何一點或部分以提供、興建及維修第二期內的行人通道，惟應盡量減低造成的滋擾及就其造成的任何損壞作出彌補。」

7. 通道範圍

批地文件相關條文：

特別條款第(61)(a)-(f)及(h)條

- (a) 除非事先獲得署長書面同意，除於本協議日期已存有的構築物外，不得在該地段中(i)在此夾附的圖則Ia上以粉紅色加橙點顯示之範圍（除非已預留由地面水平向上延伸5.5米高的淨空間作公眾行人通道之用）及(ii)在此夾附的圖則Ia上以粉紅色加棕斜線橙點顯示之範圍（除非已預留由地面水平向上延伸3.0米高的淨空間作公眾行人通道之用）內搭建或興建建築物或構築物或任何建築物或構築物的支撐物（該等在上述粉紅色加橙點範圍及粉紅色加棕斜線橙點範圍內的淨空間在下文合稱「通道範圍」）。
- (b) 承批人須於2027年6月30日或F地盤到期日或經延展的到期日（如適用）起計84個月屆滿當日（以較後者為準）或其他署長可能批准的日期或時限或之前自費及使署長在各方面滿意下以署長批准的方式、物料、標準、高度、定線及設計鋪設、平整、提供、建造、鋪設表面及美化通道範圍，包括安裝街燈、種植灌木及樹木及提供及建造其他署長可能要求的該等行人道或其他構築物，以使通道範圍可作公眾行人通道之用。
- (c) 在此特別條款第(b)分條提述的工程完成後，承批人須於整個在此協定的批租期內准許所有公眾人士於所有時間以步行或輪椅方式自由及毋須以任何方式付費地經過及再經過通道範圍以作一切合法用途。
- (d) 受限於此特別條款第(b)分條，承批人不得進行任何署長認為可能影響通道範圍的工程（署長之意見為最終並對承批人具約束力）。
- (e) 通道範圍不得用作公眾人士以步行或輪椅方式通行以外的任何其他用途。
- (f) 承批人須於整個在此協定的批租期內自費保養通道範圍至良好及充足的維修狀態，並保持其整潔，以使署長在各方面滿意。
- (h) 承批人須於整個在此協定的批租期內的所有時間准許政府及其人員、代理人、承辦商、工人或其他妥獲授權之人士有權帶同或不帶同工具、設備、裝置、機器或車輛進入、離開或再進入該地段或其任何一個或多個部分及在其上已建或將建的任何一幢或多幢建築物，以視察、檢查及監督任何由承批人按此特別條款第(b)及(f)分條下進行的工程及進行、視察、檢查及監督特別條款此特別條款第(g)分條下的工程。」

公契相關條文：

主公契中「屋苑公用地方」及「通道範圍」的定義

「『屋苑公用地方』指屋苑中擬供多於一期數的業主而非任何一名業主、一群業主或某一期數的業主獨家使用的部分，包括但不限於設施坑道、未來行人天橋相關結構（按批地文件特別條款第(12)(b)條定義）、通道範圍、位於該土地以外的該部分行人連接通道（僅為管理及保養的目的而包含在此定義中）、部分按批地文件特別條款第(59)(c)條提供的有蓋行人通道（僅為管理及保養的目的而包含位於該土地以外的有蓋行人通道）、護牆、結構牆及柱、建於屋苑及服務多於一期數的建築物的地基及其他結構部分（但不包括構成車站或車廠一部分者）、屋苑公用道路、及所有其他位於屋苑內及並非供任何一名業主、一群業主或某一期數的業主獨家享用的公用地方（但不包括構成住宅發展項目公用地方或就某一期數訂立的副公契或分副公契或單邊契據中劃定或將劃定為某一期數的公用地方的地方）。屋苑公用地方將於就任何一期數訂立的副公契或分副公契或單邊契據附夾的圖則上更詳細標明。」

「『通道範圍』指批地文件特別條款第(61)(a)條所定義的通道範圍。」

主公契第二附表第II部分的第4(d)條

「受限於批地文件的條文及財政司司長法團作為政府樓宇業主於批地文件、本主公契及任何副公契或分副公契或單邊契據下的權利、地役權及特權，所有公眾人士有權：

- (d) 於所有時間自由及免付任何性質的費用徒步或乘坐輪椅經過及再經過通道範圍作所有合法用途；

惟公眾人士行使前述權利時不能影響或損害於批地文件、本主公契及任何副公契或分副公契或單邊契據底下保留予財政司司長法團作為政府樓宇業主的權利、地役權及特權。」

C. 根據批地文件規定須由期數中的住宅物業的擁有人出資管理、營運或維持以供公眾使用的休憩用地

不適用

D. 期數所位於的土地中為施行《建築物（規劃）規例》（第113章，附屬法例F）第21條而撥供公眾用途的部分

不適用

就上述的供公眾使用的任何該等設施及休憩用地，及土地中的該等部分，公眾有權按照批地文件或撥出私人地方供公眾使用的契據（視屬何情況而定）使用該等設施或休憩用地，或土地中的該等部分。

就上述B或C部分所述的任何該等設施及休憩用地，該等設施或休憩用地按規定須由期數中的住宅物業的擁有人出資管理、營運或維持，及該等擁有人按規定須以由有關住宅物業分攤的管理開支，應付管理、營運或維持該等設施或休憩用地的部分開支。

備註：

1. 在本章節中，所有對「特別條款」的提述均為對批地文件的特別條款的提述，而「主公契」及「副公契」則分別指發展項目的主公契及管理協議及期數的副公契及管理協議。
2. 根據一封由地政總署鐵路發展組於2020年10月21日發出並已於土地註冊處以文件摘要編號20113001010307註冊的信件（「該信件」），批地文件內規定完成發展、平整、建造或提供（視屬何種情況而定）以下範圍及設施之日期將被更改如下：

特別條款	描述	於以下日期或之前完成
(12)(b)	建造連接未來行人天橋的結構性支撐物及接駁位	2027年3月23日
(13)(a)	平整綠色範圍	2027年6月10日
(17)(a)	平整綠色圓點範圍	2027年3月23日
(29)(a)	提供政府樓宇	2024年12月11日
(43)(a)	提供公共休憩用地	2027年3月23日
(59)(c)	提供行人通道	2027年3月23日

A. Facilities that are required under the land grant to be constructed and provided for the Government, or for public use

1. Footbridge Associated Structures and Future Footbridge Associated Structures

Relevant provisions of the land grant:

Special Condition No.(12)(a), (b), (e), (f) and (g)

- “ (a) The Grantee has at the date of this Agreement at his own expense erected, provided and constructed within the lot columns and other structural supports and connections (which columns and other structural supports and connections are hereinafter collectively referred to as "the Footbridge Associated Structures") for linking the lot to the existing footbridge as shown and marked "EW" on Plan Ia annexed hereto (hereinafter referred to as "the Existing Footbridge") with a minimum clear internal width of 3.0 metres and a clear internal headroom of 2.4 metres and a minimum vertical clearance between the level of 11.7 metres above the HKPD and the level of 18.6 metres above the HKPD located at the positions shown and marked through the points U1 and V1 on Plan Ia annexed hereto. The Grantee shall thereafter manage and maintain at his own expense the Footbridge Associated Structures in all respects to the satisfaction of the Director.
- (b) The Grantee shall on or before the 30th day of June 2026 or the expiry of 96 months from the Due Date or, if applicable, the Extended Due Date of Site C, whichever is the later or such other date or period as may be approved by the Director at his own expense and in all respects to the satisfaction of the Director erect, provide and construct within the lot the columns and such other structural supports and connections as may be required by the Director (which columns and such other structural supports and connections are hereinafter collectively referred to as "the Future Footbridge Associated Structures") with such materials and to such standards, levels, alignment, disposition and designs as may be required or approved by the Director and thereafter manage and maintain at his own expense the Future Footbridge Associated Structures for linking the lot to a future footbridge with such minimum clear internal width, such clear internal headroom and such minimum vertical clearance between such levels all to be determined by the Director which may be located at a position between the points U3 and V3 as shown and marked on Plan Ia annexed hereto or at such other locations and through such other points as may be approved in writing by the Director. For the avoidance of doubt, there is no guarantee that the future footbridge will be constructed.
- (e) Throughout the term hereby agreed to be granted, there is reserved unto the Government, its officers, contractors, agents, workmen, employees and other duly authorized personnel with or without tools, equipment, plant, machinery or vehicles free of all costs charges and expenses the right to enter into, upon and through the lot or any part or parts thereof and in, under, through, on or over any building or buildings or any part thereof erected thereon at all times:
- (i) to carry out works for the purposes of connecting the future footbridge to the Future Footbridge Associated Structures (which connection works are hereinafter referred to as "the Connections") and thereafter to enjoy the easement of support of the Connections and the Existing Footbridge and the future footbridge; and

- (ii) to repair and maintain the Connections and the Existing Footbridge and the future footbridge.

The Government, its officers, contractors, agents, workmen and employees shall have no liability in respect of any loss, damage, nuisance or disturbance whatsoever caused to or suffered by the Grantee arising out of or incidental to the exercise by it or them of the rights conferred under this sub-clause, and no claim shall be made against it or them by the Grantee in respect of any such loss, damage, nuisance or disturbance.

- (f) When called upon to do so by the Director, the Grantee shall at his own expense and in all respects to the satisfaction of the Director execute all necessary works as shall be required or approved by the Director for the temporary closure of any opening in the building or buildings erected or to be erected on the lot so as to enable the Existing Footbridge and the future footbridge to be connected thereto. All necessary maintenance works for the temporary closure shall be the responsibility of the Grantee and shall be carried out at his own expense to the satisfaction of the Director.
- (g) The Grantee has at the date of this Agreement provided and shall throughout the term hereby agreed to be granted keep at his own expense and in all respects to the satisfaction of the Director a public pedestrian access open for use by the public free of charge and without any interruption so as to link up the Existing Footbridge at such location between the points U1 and V1 shown and marked on Plan Ia annexed hereto and the ground level at such location between the points through U2 and V2 shown and marked on Plan Ia annexed hereto during the operational hours of the Wong Chuk Hang Station as defined in Special Condition No. (46) (a) hereof.”

Relevant provisions of the deed of mutual covenant:

Definitions of “Estate Common Areas” and “Station” in PDMC

“ “Estate Common Areas” means those parts of the Estate which are intended for use by Owners of more than one Phase and not for the sole benefit of any Owner, group of Owners or Owners of a particular Phase including, but not limited to, the Utility Trenches, the Future Footbridge Associated Structures (as defined in Special Condition No.(12)(b) of the Government Grant), the Passage Area, such part of the Pedestrian Link located outside the Land (which are included in this definition solely for management and maintenance purposes), part of the covered pedestrian walkway provided under Special Condition No.(59)(c) of the Government Grant (which solely for management and maintenance purposes, including those part of the covered pedestrian walkway located outside the Land), parapet walls, structural walls and columns, the foundations and other structural elements of the buildings erected on the Estate serving more than one Phase (but excluding those forming part of the Station or the Depot), common estate roads, and all other communal areas within the Estate not used for the sole benefit of any Owner, group of Owners or Owners of a particular Phase (but excluding those areas forming parts of the Residential Development Common Areas or the Common Areas of a particular Phase as designated or to be designated in the Sub-Deed of Mutual Covenant or Sub-Sub-Deed of Mutual Covenant or Deed Poll to be executed in connection with such Phase). The Estate Common Areas shall be more particularly identified on plans to be annexed to any Sub-Deed of Mutual Covenant or Sub-Sub-Deed of Mutual Covenant or Deed Poll to be executed in connection with any Phase.”

“Station” means (i) the Wong Chuk Hang Station (as defined in Special Condition No.(46)(a) of the Government Grant) constructed on or within the Wong Chuk Hang Station Site (as defined in Special Condition No.(1)(h) of the Government Grant) of the Land comprising a railway station and ancillary railway structures, facilities and roads, (ii) the spaces provided or to be provided within the Wong Chuk Hang Station Site for the parking, manoeuvring, loading and unloading of motor vehicles for the operational needs of the Wong Chuk Hang Station as referred to in Special Condition No.(70) of the Government Grant and (iii) the Footbridge Associated Structures (as defined in Special Condition No.(12)(a) of the Government Grant); for the avoidance of doubt, the following shall not form part of the Station: all utilities, services, trenches, pits and facilities which serve the Depot or the Estate or any part thereof, and all finishes of the Depot and the Estate.”

Definition of “Estate Common Areas in Phase 2” in SDMC

“Estate Common Areas in Phase 2” means those parts of the Estate Common Areas situated within Phase 2 which are intended for use by Owners of the Estate and not for the sole benefit of any Owner, group of Owners or Owners of a particular Phase including, but not limited to the Future Footbridge Associated Structures (as defined in Special Condition No.(12)(b) of the Government Grant), the Pedestrian Walkway in Phase 2 (including those parts provided or to be provided adjacent to Site B but outside the Land solely for management and maintenance purposes), part of the Phase 2 Greenery Areas, planters, fireman’s lift lobbies, accessible lift, hose reels, electrical duct, fire shutter, corridors, staircases and landings, parapet walls, structural walls and columns, the foundations and other structural elements of the buildings erected on the Estate serving more than one Phase and within Site B (but excluding those forming part of the Station or the Depot), but excluding the Residential Development Common Areas in Phase 2, the Phase 2 Common Areas, the Phase 2 Residential Common Areas and the Phase 2 Car Park Common Areas; and the Estate Common Areas in Phase 2 are for the purpose of identification shown coloured Indigo, Indigo Cross-hatched Black and Indigo Cross-hatched Black Stippled Black on the plans certified as to their accuracy by the Authorized Person and annexed hereto.”

Clause 8(c) of Section E of PDMC

“MTR as Owner of the Station and the Depot shall be responsible to provide and keep at its own expenses and in all respects to the satisfaction of the Director the public pedestrian access as required under Special Condition No.(12)(g) of the Government Grant open for use by the public free of charge and without any interruption during the operational hours of the Wong Chuk Hang Station (as defined in Special Condition No.(46)(a) of the Government Grant).”

Clause 2(b) of Part II of the Second Schedule to PDMC

“The rights for the Manager with or without surveyors workmen and others to carry out all necessary works required by the Director for the temporary closure of any opening in the building or buildings (excluding the Government Accommodation) erected on the Land so as to enable the connection of pedestrian passageways, subways or footbridges to the buildings erected on the Land or the Future Footbridge Associated Structures (as defined in Special Condition No.(12)(b) of the Government Grant) pursuant to the provisions of Special Condition No.(12) of the Government Grant or the Pedestrian Link and the covered pedestrian walkway (as referred to in Special Condition No.(59)(c) of the Government Grant) or such other structures or buildings outside the Land as may be required under the Government Grant. The Manager in pursuance of any such works shall notify the Owners in writing as to the areas

or parts of the Land and the Development which the Owners may not use while such works are being carried out and the Owners shall comply with the requirements of such notification PROVIDED THAT the ingress to or egress from the Government Accommodation shall not be interrupted and the proper use and enjoyment of the Government Accommodation shall not be affected.”

Clause 4(a) of Part II of the Second Schedule to PDMC

“Subject to the terms of the Government Grant and the rights, easements and privileges of FSI as the Owner of the Government Accommodation under the Government Grant, this Deed and any Sub-Deed of Mutual Covenant or Sub-Sub-Deed of Mutual Covenant or Deed Poll, the rights for all members of the public

- (a) to use the public pedestrian access provided by MTR under Special Condition No.(12)(g) of the Government Grant during the operational hours of the Wong Chuk Hang Station as defined in Special Condition No.(46)(a) of the Government Grant;

PROVIDED THAT the exercise of such rights by the members of the public shall not in any way adversely affect or prejudice the rights, easements and privileges reserved to FSI as the Owner of the Government Accommodation under the Government Grant, this Deed and any Sub-Deed of Mutual Covenant or Sub-Sub-Deed of Mutual Covenant or Deed Poll.”

Clause 3(a) of Part II of the Second Schedule to SDMC

“Without prejudice to the generality of the rights reserved to MTR in Clause 3 of Part II of the Second Schedule to the Principal Deed :-

- (a) the right for MTR with all necessary tools, equipment, plant and materials with or without servants, workmen and others at all reasonable times on reasonable prior written notice (except in case of emergency) to enter into and upon any part or parts of Site B (other than the Units sold or assigned by MTR) for the purpose of erecting, providing and constructing footbridges, columns, structural supports and connections including but not limited to the Future Footbridge Associated Structures (as defined in Special Condition No.(12)(b) of the Government Grant) at such point or points or part or parts of Site B as it may require from time to time causing as little disturbance as possible and making good any damage caused thereby.”

2. Green Area and Structures

Relevant provisions of the land grant:

Special Condition No.(13)(a)

- “ (a) The Grantee shall:
- (i) on or before the 31st day of March 2026 or the expiry of 84 months from the Due Date or, if applicable, the Extended Due Date of Site D, whichever is the later or such other

date or period as may be approved by the Director, at his own expense, in such manner with such materials and to such standards, levels, alignment and design as the Director shall approve and in all respects to the satisfaction of the Director:

- (I) lay and form those portions of future public roads shown coloured green on Plan Ia annexed hereto (hereinafter referred to as "the Green Area"); and
 - (II) provide and construct such bridges, tunnels, over-passes, under-passes, culverts, viaducts, flyovers, pavements, roads or such other structures as the Director in his sole discretion may require (hereinafter collectively referred to as "the Structures") so that building, vehicular and pedestrian traffic may be carried on the Green Area.
- (ii) on or before the 31st day of March 2026 or the expiry of 84 months from the Due Date or, if applicable, the Extended Due Date of Site D, whichever is the later or such other date or period as may be approved by the Director, at his own expense and to the satisfaction of the Director, surface, kerb and channel the Green Area and provide the same with such gullies, sewers, drains, fire hydrants with pipes connected to water mains, services, street lights, traffic signs, street furniture and road markings and plant as the Director may require; and
- (iii) maintain at his own expense the Green Area together with the Structures and all structures, surfaces, gullies, sewers, drains, fire hydrants, services, street lights, traffic signs, street furniture, road markings and plant, constructed, installed and provided thereon or therein to the satisfaction of the Director until such time as possession of the Green Area shall have been re-delivered in accordance with Special Condition No. (14) hereof."

Special Condition No.(14)

"For the purpose only of carrying out the necessary works specified in Special Condition No. (13) hereof, the Grantee shall on the date of this Agreement be granted possession of the Green Area. The Green Area shall be re-delivered to the Government on demand and in any event shall be deemed to have been re-delivered to the Government by the Grantee on the date of a letter from the Director indicating that these Conditions have been complied with to his satisfaction. The Grantee shall at all reasonable times while he is in possession of the Green Area allow free access over and along the Green Area for all Government and public vehicular and pedestrian traffic and shall ensure that such access shall not be interfered with or obstructed by the carrying out of the works whether under Special Condition No. (13) hereof or otherwise."

Special Condition No.(15)

"The Grantee shall not without the prior written consent of the Director use the Green Area for the purpose of storage or for the erection of any temporary structure or for any purposes other than the carrying out of the works specified in Special Condition No. (13) hereof."

Special Condition No.(16)

"The Grantee shall at all reasonable times while he is in possession of the Green Area permit the Government, the Director and his officers, contractors and agents and any persons authorized by the Director, the right of ingress, egress and regress to, from and through the lot and the Green Area for the purpose of inspecting, checking and supervising any works to be carried out in compliance with Special Condition No. (13)(a) hereof and the carrying out, inspecting, checking and supervising of the works under Special Condition No. (13)(b) hereof and any other works which the Director may consider necessary in the Green Area."

Relevant provisions of the deed of mutual covenant:

Definitions of "Green Area" and "Structures" in PDMC

" "Green Area" means those portions of public roads laid and formed and future public roads to be laid and formed by MTR at the area shown coloured green on Plan Ia annexed to the Government Grant pursuant to Special Condition No.(13)(a)(i)(I) of the Government Grant."

" "Structures" means the Structures as defined in Special Condition No.(13)(a)(i)(II) of the Government Grant."

Clause 1(b) of Section E of PDMC

"For the avoidance of doubt, subject to the provisions in the Government Grant and this Deed, the construction of the Green Area, the Structures, the Stippled Green Area and the Stippled Green Area Structures shall be carried out and the construction costs therefor shall be borne by MTR as the original grantee of the Land under the Government Grant, and upon the completion of the construction of the Green Area, the Structures, the Stippled Green Area and the Stippled Green Area Structures or any part thereof by MTR to the satisfaction of the Director, the Green Area, the Structures, the Stippled Green Area and the Stippled Green Area Structures or such completed part thereof shall be managed and controlled by the Manager in accordance with this Deed until re-delivery to the Government."

Clause 1 of Section F of PDMC

"Subject to Clause 12 of this Section, from time to time as occasion may require there shall be meetings of the Owners of the Estate to discuss and decide matters concerning the Estate and/or (prior to re-delivery to the Government pursuant to the Government Grant) the Green Area, the Structures, the Stippled Green Area and the Stippled Green Area Structures as hereinafter mentioned and in regard to such meetings the provisions of this Section shall apply. The procedure at a meeting of the Owners of the Estate shall be as is determined by the Owners of the Estate."

Clause 9(a) of Section F of PDMC

Any resolution on any matter concerning the Estate and/or the Green Area, the Structures, the Stippled Green Area and the Stippled Green Area Structures, save only those matters referred to in Clause 11 of this Section, passed at a duly convened meeting by a majority vote of the Owners present in person or by proxy and voting shall be binding on all the Owners PROVIDED THAT:

- (i) the notice convening the meeting shall have been duly given and shall have specified the intention to propose a resolution concerning such matter;
- (ii) no resolution purporting to be passed at any such meeting concerning any matter not mentioned in such notice shall be valid;
- (iii) no resolution shall be valid to the extent that it purports to alter or amend the provisions of this Deed or is inconsistent therewith save as herein specifically provided;
- (iv) no resolution shall be valid to the extent that it is in conflict with or contrary to any order ruling or judgment of the Hong Kong courts or any mandatory provision of any statute;
- (v) no resolution shall have any adverse effect on the use, operation or maintenance of the Government Accommodation or any part thereof or the services and facilities supplying the Government Accommodation;
- (vi) any resolution on matters or issues which in the reasonable opinion of MTR may affect or have an impact on the Mass Transit Railway, the Mass Transit Railway Structures and Installations, the Station or the Depot or any part thereof, shall be subject to the agreement of MTR; and
- (vii) no resolution shall damage, interfere with, obstruct or endanger the construction, use, operation, maintenance or safety of the Mass Transit Railway, the Mass Transit Railway Structures and Installations, the Station or the Depot or any part thereof.”

Clause 1(b)(ii) of Section G of PDMC

“ The function of the Development Owners’ Committee shall be to:

- (ii) discuss issues relating to the maintenance and management of the Estate Common Areas, Estate Common Services and Facilities, Residential Development Common Areas, Residential Development Common Services and Facilities, the Green Area, the Structures, the Stippled Green Area and the Stippled Green Area Structures and to make known to the Manager its views;”

Clause 1(a) Section I of PDMC

“Subject to the provisions of the Ordinance, subject to the rights, easements and privileges of FSI as Owner of the Government Accommodation under this Deed, any Sub-Deed of Mutual Covenant or Sub-Sub-Deed of Mutual Covenant or Deed Poll and the Government Grant and subject to as provided in this Deed, the Manager shall in respect of any part of the Estate in respect of which a Sub-Deed of Mutual Covenant has been entered into pursuant to this Deed (save and except the Government Accommodation) and (before re-delivery to the Government pursuant to the Government Grant) the Green Area, the Structures, the Stippled Green Area and the Stippled Green Area Structures have the authority to do all such acts and things as may be necessary or expedient for the management of the relevant part of the Land and the Estate (save and except the Government Accommodation) and the Green Area, the Structures, the Stippled Green Area and the Stippled Green Area Structures and anything reasonably incidental thereto for and on behalf of all Owners (save and except FSI as the Owner of the Government Accommodation) in accordance with the provisions of this Deed and each Owner of the Estate (save and except FSI as the Owner of the Government Accommodation) irrevocably appoints the Manager as agent in respect of any matter concerning the Common Areas and the Common Services and Facilities and all other matters duly authorized under this Deed or any Sub-Deed of Mutual Covenant or Sub-Sub-Deed of Mutual Covenant.”

Clause 2 of Section I of PDMC

“Subject to the Ordinance and the provisions of this Deed, the Common Areas, the Common Services and Facilities and (before re-delivery to the Government pursuant to the Government Grant) the Green Area, the Structures, the Stippled Green Area and the Stippled Green Area Structures shall be under the exclusive control of the Manager.”

Clause 4(b) of Section I of PDMC

“The Manager, or in the absence of the Manager, the Owners’ Corporation or the Chairman of the Development Owners’ Committee, shall have the power to accept service of notice and demand by the Government for delivery of possession of the Green Area, the Structures, the Stippled Green Area and/or the Stippled Green Area Structures or any part thereof and deliver the Green Area, the Structures, the Stippled Green Area and/or the Stippled Green Area Structures or any part thereof to the Government pursuant to the Government Grant for and on behalf of all the Owners of the Land.”

Clause 5(b)(II) of Section J of PDMC

“Notwithstanding anything contained in this Deed to the contrary, the Owner of the Station and the Depot shall share, and contribute to, (i) the costs and expenses of the Estate Common Areas and Facilities Management Sub-Budget in so far as the same is attributable to the maintenance and management of the Green Area, the Structures, the Stippled Green Area, the Stippled Green Area Structures and the Passage Area but not otherwise and (ii) the expenditure for major works of a capital nature or of a kind not expected to be incurred annually in respect of the Green Area, the Structures, the Stippled Green Area, the Stippled Green Area Structures and the Passage Area but not otherwise in the proportion that the construction gross floor area of the Station and the Depot bears to the total of the construction gross floor area of the Station and the Depot and the construction gross floor areas of all those parts of the Estate which have been completed for the time being (“the Construction GFA of the Completed Estate”). The Manager shall prepare a sub-sub-budget under the Estate Common Areas and Facilities Management Sub-Budget showing the estimated annual costs and expenses for the management and maintenance of the Green Area, the Structures, the Stippled Green Area, the Stippled Green Area Structures and the Passage Area and such expenditure for major works of a capital nature or of a kind not expected to be incurred annually in respect of the Green Area, the Structures, the Stippled Green Area, the Stippled Green Area Structures and the Passage Area for the ensuing year and a copy of such sub-budget shall be sent to the Owner of the Station and the Depot for its information. For the purpose of this sub-clause, the construction gross floor area of the Station and the Depot is 53,726 m² and the “Construction GFA of the Completed Estate” shall mean the actual gross floor area of the completed part(s) of the Estate irrespective of whether that gross floor area is accountable or non-accountable under the Buildings Ordinance or the Government Grant as certified by the authorized person(s) for the Estate or the relevant Phase.”

3. Stippled Green Area and Stippled Green Area Structures

Relevant provisions of the land grant:

Special Condition No.(17)(a)

“ (a) The Grantee shall:

(i) on or before the 30th day of June 2026 or the expiry of 96 months from the Due Date or, if applicable, the Extended Due Date of Site C, whichever is the later or such other date or period as may be approved by the Director, at his own expense, in such manner with such materials and to such standards, levels, alignment and design as the Director shall approve and in all respects to the satisfaction of the Director:

(I) lay and form those portions of future public roads in the air stratum shown coloured stippled green on Plan Ia annexed hereto between the level of 2 metres below the ground, level or levels and the level of 5.5 metres above the ground level or levels (hereinafter referred to as "the Stippled Green Area"). For the avoidance of doubt, the air stratum of the Stippled Green Area and the Fifth Reserved Area are the same; and

(II) provide and construct such bridges, tunnels, over-passes, under-passes, culverts, viaducts, flyovers, pavements, roads or such other - structures as the Director in his sole discretion may require (hereinafter collectively referred to as "the Stippled Green Area Structures")

so that building, vehicular and pedestrian traffic may be carried on the Stippled Green Area;

(ii) on or before the 30th day of June 2026 or the expiry of 96 months from the Due Date or, if applicable, the Extended Due Date of Site C, whichever is the later or such other date or period as may be approved by the , Director, at his own expense and to the satisfaction of the Director, surface, kerb and channel the Stippled Green Area and provide the same with such gullies, sewers, drains, fire hydrants with pipes connected to water mains, services, street lights, traffic signs, street furniture and road markings and plant as the Director may require; and

(iii) maintain at his own expense the Stippled Green Area together with the Stippled Green Area Structures and all structures, surfaces, gullies, sewers, drains, fire hydrants, services, street lights, traffic signs, street furniture, road markings and plant constructed, installed and provided thereon or therein to the satisfaction of the Director until such time as possession of the Stippled Green Area shall have been re-delivered in accordance with Special Condition No. (18) hereof.”

Special Condition No.(18)

“For the purpose only of carrying out the necessary works specified in Special Condition No. (17) hereof, the Grantee shall on the date of this Agreement be granted possession of the Stippled Green Area. The Stippled Green Area shall be re-delivered to the Government on demand and in any event shall be deemed to have been re-delivered to the Government by the Grantee on the date of a letter from the Director indicating that these Conditions have been complied with to his satisfaction. The Grantee shall at all reasonable times while he is in possession of the Stippled Green Area allow free access over and along the Stippled Green Area for all Government and public vehicular and pedestrian

traffic and shall ensure that such access shall not be interfered with or obstructed by the carrying out of the works whether under Special Condition No. (17) hereof or otherwise.”

Special Condition No.(19)

“The Grantee shall not without the prior written consent of the Director use the Stippled Green Area for the purpose of storage or for the erection of any temporary structure or for any purposes other than the carrying out of the works specified in Special Condition No. (17) hereof.”

Special Condition No.(20)

“The Grantee shall at all reasonable times while he is in possession of the Stippled Green Area permit the Government, the Director and his officers, contractors and agents and any persons authorized by the Director, the right of ingress, egress and regress to, from and through the lot and the Stippled Green Area for the purpose of inspecting, checking and supervising any works to be carried out in compliance with Special Condition No. (17)(a) hereof and the carrying out, inspecting, checking and supervising of the works under Special Condition No. (17)(b) hereof and any other works which the Director may consider necessary in the Stippled Green Area.”

Relevant provisions of the deed of mutual covenant:

Definitions of “Stippled Green Area” and “Stippled Green Area Structures” in PDMC

“ “Stippled Green Area” means those portions of public roads laid and formed and future public roads to be laid and formed by MTR in the air stratum shown coloured stippled green on Plan Ia annexed to the Government Grant between the level of 2 metres below the ground level or levels and the level of 5.5 metres above the ground level or levels pursuant to in Special Condition No.(17)(a)(i)(I) of the Government Grant.”

“ “Stippled Green Area Structures” means the Stippled Green Area Structures as defined in Special Condition No.(17)(a)(i)(II) of the Government Grant.”

Clause 1(b) of Section E of PDMC

“For the avoidance of doubt, subject to the provisions in the Government Grant and this Deed, the construction of the Green Area, the Structures, the Stippled Green Area and the Stippled Green Area Structures shall be carried out and the construction costs therefor shall be borne by MTR as the original grantee of the Land under the Government Grant, and upon the completion of the construction of the Green Area, the Structures, the Stippled Green Area and the Stippled Green Area Structures or any part thereof by MTR to the satisfaction of the Director, the Green Area, the Structures, the Stippled Green Area and the Stippled Green Area Structures or such completed part thereof shall be managed and controlled by the Manager in accordance with this Deed until re-delivery to the Government.”

Clause 1 of Section F of PDMC

“Subject to Clause 12 of this Section, from time to time as occasion may require there shall be

meetings of the Owners of the Estate to discuss and decide matters concerning the Estate and/or (prior to re-delivery to the Government pursuant to the Government Grant) the Green Area, the Structures, the Stippled Green Area and the Stippled Green Area Structures as hereinafter mentioned and in regard to such meetings the provisions of this Section shall apply. The procedure at a meeting of the Owners of the Estate shall be as is determined by the Owners of the Estate.”

Clause 9(a) of Section F of PDMC

“Any resolution on any matter concerning the Estate and/or the Green Area, the Structures, the Stippled Green Area and the Stippled Green Area Structures, save only those matters referred to in Clause 11 of this Section, passed at a duly convened meeting by a majority vote of the Owners present in person or by proxy and voting shall be binding on all the Owners PROVIDED THAT:

- (i) the notice convening the meeting shall have been duly given and shall have specified the intention to propose a resolution concerning such matter;
- (ii) no resolution purporting to be passed at any such meeting concerning any matter not mentioned in such notice shall be valid;
- (iii) no resolution shall be valid to the extent that it purports to alter or amend the provisions of this Deed or is inconsistent therewith save as herein specifically provided;
- (iv) no resolution shall be valid to the extent that it is in conflict with or contrary to any order ruling or judgment of the Hong Kong courts or any mandatory provision of any statute;
- (v) no resolution shall have any adverse effect on the use, operation or maintenance of the Government Accommodation or any part thereof or the services and facilities supplying the Government Accommodation;
- (vi) any resolution on matters or issues which in the reasonable opinion of MTR may affect or have an impact on the Mass Transit Railway, the Mass Transit Railway Structures and Installations, the Station or the Depot or any part thereof, shall be subject to the agreement of MTR; and
- (vii) no resolution shall damage, interfere with, obstruct or endanger the construction, use, operation, maintenance or safety of the Mass Transit Railway, the Mass Transit Railway Structures and Installations, the Station or the Depot or any part thereof.”

Clause 1(b)(ii) of Section G of PDMC

“ The function of the Development Owners’ Committee shall be to:

- (ii) discuss issues relating to the maintenance and management of the Estate Common Areas, Estate Common Services and Facilities, Residential Development Common Areas, Residential Development Common Services and Facilities, the Green Area, the Structures, the Stippled Green Area and the Stippled Green Area Structures and to make known to the Manager its views;”

Clause 1(a) of Section I of PDMC

“Subject to the provisions of the Ordinance, subject to the rights, easements and privileges of FSI as Owner of the Government Accommodation under this Deed, any Sub-Deed of Mutual Covenant or

Sub-Sub-Deed of Mutual Covenant or Deed Poll and the Government Grant and subject to as provided in this Deed, the Manager shall in respect of any part of the Estate in respect of which a Sub-Deed of Mutual Covenant has been entered into pursuant to this Deed (save and except the Government Accommodation) and (before re-delivery to the Government pursuant to the Government Grant) the Green Area, the Structures, the Stippled Green Area and the Stippled Green Area Structures have the authority to do all such acts and things as may be necessary or expedient for the management of the relevant part of the Land and the Estate (save and except the Government Accommodation) and the Green Area, the Structures, the Stippled Green Area and the Stippled Green Area Structures and anything reasonably incidental thereto for and on behalf of all Owners (save and except FSI as the Owner of the Government Accommodation) in accordance with the provisions of this Deed and each Owner of the Estate (save and except FSI as the Owner of the Government Accommodation) irrevocably appoints the Manager as agent in respect of any matter concerning the Common Areas and the Common Services and Facilities and all other matters duly authorized under this Deed or any Sub-Deed of Mutual Covenant or Sub-Sub-Deed of Mutual Covenant.”

Clause 2 of Section I of PDMC

“Subject to the Ordinance and the provisions of this Deed, the Common Areas, the Common Services and Facilities and (before re-delivery to the Government pursuant to the Government Grant) the Green Area, the Structures, the Stippled Green Area and the Stippled Green Area Structures shall be under the exclusive control of the Manager.”

Clause 4(b) of Section I of PDMC

“The Manager, or in the absence of the Manager, the Owners’ Corporation or the Chairman of the Development Owners’ Committee, shall have the power to accept service of notice and demand by the Government for delivery of possession of the Green Area, the Structures, the Stippled Green Area and/or the Stippled Green Area Structures or any part thereof and deliver the Green Area, the Structures, the Stippled Green Area and/or the Stippled Green Area Structures or any part thereof to the Government pursuant to the Government Grant for and on behalf of all the Owners of the Land.”

Clause 5(b)(II) of Section J of PDMC

“Notwithstanding anything contained in this Deed to the contrary, the Owner of the Station and the Depot shall share, and contribute to, (i) the costs and expenses of the Estate Common Areas and Facilities Management Sub-Budget in so far as the same is attributable to the maintenance and management of the Green Area, the Structures, the Stippled Green Area, the Stippled Green Area Structures and the Passage Area but not otherwise and (ii) the expenditure for major works of a capital nature or of a kind not expected to be incurred annually in respect of the Green Area, the Structures, the Stippled Green Area, the Stippled Green Area Structures and the Passage Area but not otherwise in the proportion that the construction gross floor area of the Station and the Depot bears to the total of the construction gross floor area of the Station and the Depot and the construction gross floor areas of all those parts of the Estate which have been completed for the time being (“the Construction GFA of the Completed Estate”). The Manager shall prepare a sub-sub-budget under the Estate Common Areas and Facilities Management Sub-Budget showing the estimated annual costs and expenses for the management and maintenance of the Green Area, the Structures, the Stippled Green Area, the Stippled Green Area Structures and the Passage Area and such expenditure for major works of a capital nature or of a kind not expected to be incurred annually in respect of the Green Area, the

Structures, the Stippled Green Area, the Stippled Green Area Structures and the Passage Area for the ensuing year and a copy of such sub-budget shall be sent to the Owner of the Station and the Depot for its information. For the purpose of this sub-clause, the construction gross floor area of the Station and the Depot is 53,726 m² and the “Construction GFA of the Completed Estate” shall mean the actual gross floor area of the completed part(s) of the Estate irrespective of whether that gross floor area is accountable or non-accountable under the Buildings Ordinance or the Government Grant as certified by the authorized person(s) for the Estate or the relevant Phase.”

4. Government Accommodation

Relevant provisions of the land grant:

Special Condition No.(29)(a) and (b)

“ (a) The Grantee shall at his own expense and in all respects to the satisfaction of the Director erect, construct and provide within the lot, in a good workmanlike manner and in accordance with the Technical Schedule annexed hereto (hereinafter referred to as "the Technical Schedule") and the plans approved under Special Condition No. (30)(a) hereof, the following accommodation:

- (i) One hostel for moderately mentally handicapped persons with a net operational floor area of 557 square metres (hereinafter referred to as "the Hostel") to be completed and made fit for occupation and operation within 84 months from the date of this Agreement; and
- (ii) One integrated vocational rehabilitation services centre with a net operational floor area of 653 square metres (hereinafter referred to as "the Rehabilitation Services Centre") to be completed and made fit for occupation and operation within 84 months from the date of this Agreement;

(which accommodation together with any other areas, facilities, services and installations exclusive thereto as the Director may in his absolute discretion determine (whose determination shall be conclusive and binding on the Grantee) are hereinafter collectively referred to as "the Government Accommodation").

- (b) The Government hereby reserves the right to alter or vary in its absolute discretion at any time the use of the Government Accommodation or any part thereof.”

Special Condition No.(36)(a)

“The Grantee shall when called upon so to do by the Director assign to F.S.I. (which expression shall if the context permits include its successors and assigns), with vacant possession, free from incumbrances, at the expense of the Grantee, the undivided shares specified in sub-clause (b) of this Special Condition or part thereof together with the right to the exclusive use, occupation and enjoyment of the Government Accommodation or part thereof and the Grantee shall complete the assignment of the Government Accommodation or any part thereof in respect of which a certificate of

completion shall have been issued under Special Condition No. (35) hereof within such time or times as may be specified in writing by the Director.”

Special Condition No.(38)

“The Director shall have the right to demand at any time before the assignment of the Government Accommodation pursuant to Special Condition No. (36) hereof, delivery of vacant possession of the Government Accommodation or such part thereof as required by the Director in respect of which a certificate of completion shall have been issued under Special Condition No. (35) hereof and the Grantee shall upon such demand deliver the same to the Government for its exclusive use, occupation and operation upon such terms and conditions as the Director may consider appropriate.”

Relevant provisions of the deed of mutual covenant:

Definition of “Government Accommodation” in PDMC

“ “Government Accommodation” means collectively the Hostel and the Rehabilitation Services Centre as respectively defined in Special Conditions No.(29)(a)(i) and (29)(a)(ii) of the Government Grant each together with any other areas, facilities, services and installations exclusive thereto as the Director may in his absolute discretion determine constructed and to be constructed on the Land as part of the Development pursuant to Special Condition No.(29) of the Government Grant.”

Clause 9(a) of Section E of PDMC

“FSI as the Owner of the Government Accommodation shall be responsible for the maintenance and management of the Government Accommodation (excluding the Items) but not any other part of the Development nor any part of the Green Area, the Structures, the Stippled Green Area and the Stippled Green Area Structures. FSI as the Owner of the Government Accommodation shall in accordance with Special Condition No.(64)(a)(iv)(I)(2) of the Government Grant be liable for payment of the management and maintenance charges only in respect of facilities or services which actually serve the Government Accommodation or are used by the occupier thereof, his servants, contractors, agents or visitors PROVIDED HOWEVER THAT the liability of FSI shall be as determined by the GPA or the person nominated by the Director for this purpose and in any event shall not exceed the proportion of the management and maintenance charges which the Gross Floor Area of the Government Accommodation bears to the Gross Floor Area of all the buildings erected or to be erected on the Land (for those management and maintenance charges in respect of the Land) or all the buildings erected or to be erected on Site A (for those management and maintenance charges in respect of Site A exclusively) and shall only commence from the date of the assignment or the date of taking over of the Government Accommodation, whichever is the earlier and PROVIDED FURTHER THAT FSI as the Owner of the Government Accommodation shall incur no liability for payment of any management and maintenance charges unless and until the amount of the same shall have first been approved in writing by the GPA or person nominated by the Director for this purpose. FSI as the Owner of the Government Accommodation shall have no liability for any contribution towards any management and maintenance charges for any other part of the Development (whether Common Areas or otherwise) or any part of the Green Area, the Structures, the Stippled Green Area and the Stippled Green Area Structures or for the provision of facilities or services which do not, in the opinion of the GPA or person nominated by the Director for this purpose, directly serve or otherwise directly benefit

the Government Accommodation. FSI as the Owner of the Government Accommodation shall not be liable to make any contribution towards the Management Charges.”

Clause 9(a)(v) of Section F of PDMC

“Any resolution on any matter concerning the Estate and/or the Green Area, the Structures, the Stippled Green Area and the Stippled Green Area Structures, save only those matters referred to in Clause 11 of this Section, passed at a duly convened meeting by a majority vote of the Owners present in person or by proxy and voting shall be binding on all the Owners PROVIDED THAT:-

- (v) no resolution shall have any adverse effect on the use, operation or maintenance of the Government Accommodation or any part thereof or the services and facilities supplying the Government Accommodation.”

Clause 1(e) of Section G of PDMC

“No resolution of the Development Owners’ Committee or any Owners’ Sub Committee of a Phase shall be in conflict with the provisions of this Deed or of any judgment or order of the Hong Kong courts nor adversely affect the use, operation or maintenance of the Government Accommodation or any part thereof.”

Clause 12 of Section G of PDMC

“The Development Owners’ Committee shall invite to all of its meetings the person nominated from time to time by FSI as Owner of the Government Accommodation as its representative and provide such person free of charge with agendas, notices and minutes of the said meetings in the manner set out in Clause 3(a) of Section L of this Deed. FSI as Owner of the Government Accommodation shall notify the Development Owners’ Committee in writing of its representative from time to time. The representative of FSI as Owner of the Government Accommodation attending any meeting of the Development Owners’ Committee shall be entitled to make his views known to the Committee on any subject for discussion but shall have no vote.”

Proviso to Clause 1 of Section J of PDMC

“PROVIDED THAT subject to Clause 5(b)(II) of this Section and Clause 9(a) of Section E of this Deed, MTR in its capacity as Owner of the Station and the Depot (but not otherwise) and the Owner of the Government Accommodation shall not be required to contribute to the Management Charges or any costs charges or expenses incurred by the Manager in the maintenance and management of the Estate, and PROVIDED FURTHER THAT the Owner of the Government Accommodation shall not be required to contribute to the Special Fund or deposits respectively referred to in Clauses 2 and 9 of this Section nor any insurance premia, debris removal fees, interest, penalty charges or payment of a like nature.”

Clause 8 of Section K of PDMC

“The Building Rules and the Fitting Out Rules (including any amendment and variation made in accordance with Clause 3 of this Section) shall not adversely affect or interfere with the use, operation

and enjoyment of nor prevent, impede or restrict the access to the Government Accommodation or any part thereof.”

Clause 2 of Part I of the Second Schedule to PDMC

“ (a) Notwithstanding any provisions contained in this Deed or any Sub-Deed of Mutual Covenant or any Sub-Sub-Deed of Mutual Covenant, FSI, its lessees, tenants, licensees, and persons authorised by it and the Owners and occupiers for the time being of the Government Accommodation or any part thereof shall have the benefit of the following rights privileges and easements:

- (i) the right of shelter, support and protection for the Government Accommodation;
- (ii) the right at all times of free passage and running of gas, electricity, water, sewage, air-conditioning, telephone and all other services from and to the Government Accommodation through the gutters, sewers, drains, flues, conduits, ducts, watercourse, cables, pipes, wires and other conducting media now or during the Term laid on or running through any part of the Land and any part of the Development;
- (iii) the right at its own cost to alter, divert, vary, relay or reinstate any of the services and facilities serving exclusively the Government Accommodation or any part thereof (the “Government Accommodation Services”) at any time at its absolute discretion without any charge by and without having to obtain the approval or consent of any other Owners or the Manager PROVIDED THAT proper and adequate care and precaution shall be taken during any alteration, diversion, variation, relaying or reinstatement works of the Government Accommodation Services so as to ensure that no damage is caused to the services and facilities within the Land and serving all those parts of the Development on the Land other than the Government Accommodation;
- (iv) the right to go pass and repass over and along and to use any common parts of the Land or any common parts of the Development in connection with the proper use and enjoyment of the Government Accommodation or any part thereof and to use and receive the benefit of any common facilities within the Land or the Development;
- (v) the right at all reasonable times with or without surveyors, contractors, workmen and others and with or without vehicles, plant, equipment, material and machinery to enter upon the Land or any part of the Development for the purpose of extending or carrying out maintenance, repair, addition, alteration and other works to the Government Accommodation or any part thereof and maintenance, repair, addition, alteration, diversion, variation, relaying and reinstatement works and other works to the Government Accommodation Services or any part thereof;
- (vi) the free and uninterrupted rights of way to and from the Government Accommodation as may be required by the Director;
- (vii) the exclusive right to install, erect, exhibit, display, maintain, repair, remove and renew signs and advertisements on the walls, columns and other structural elements of, within, around and on the boundary of the Government Accommodation or any part thereof as FSI shall deem fit and the right of access over the Land or any part of the Development with or without servants, workmen and others and with or without plant, equipment, machinery and material for the purposes of inspecting, installing, erecting, exhibiting, displaying, maintaining, repairing, removing and renewing such signs and advertisements;
- (viii) the right of access to the lighting conduits, such fire services, ventilation and other

services, facilities, installations, fixtures, ancillary works, plants and materials fixed on, in or to the roof slabs, walls and other structural elements of the Government Accommodation;

- (ix) the right to alter and run additional services to serve and benefit exclusively the Government Accommodation or any part thereof on the walls, columns, beams, ceilings, roof slabs, carriageway or floor slabs and other structural elements of, in, around, within, above and below the same and the related right of access over the Land or any part of the Development with or without servants, workmen and others and with or without plant, equipment, machinery and material PROVIDED THAT proper and adequate care and precautions shall be taken during any such alteration works so as to ensure that no damage is caused to the services and facilities within the Land and serving all those parts of the Development other than the Government Accommodation; and
- (x) such other rights, privileges and easements as may be deemed necessary or desirable by the Director.

(b) The right of the Government or FSI to alter or vary at any time the use of the Government Accommodation or any part or parts thereof without having to obtain the approval or consent of MTR, the other Owners or the Manager.

(c) The exercise of the rights privileges and easements referred to in Paragraphs 2(a) to (b) above shall not be subject to any permission, approval or consent of MTR, the other Owners or the Manager.”

5. Public Open Space

Relevant provisions of the land grant:

Special Condition No.(43)(a)-(c)

- “ (a) The Grantee shall on or before the 30th day of June 2026 or the expiry of 96 months from the Due Date or, if applicable, the Extended Due Date of Site C, whichever is the later at his own expense and in all respects to the satisfaction of the Director erect, construct and provide within the lot an at-grade public open space of not less than 1,300 square metres (hereinafter referred to as "the Public Open Space"). The Public Open Space shall be located, formed, serviced, landscaped, planted, treated and provided in such manner, with such materials and with such equipment and facilities at the expense of the Grantee as the Director may require and in all respects to his satisfaction.
- (b) The Grantee shall throughout the term hereby agreed to be granted at his own expense upkeep, maintain, repair and manage the Public Open Space together with everything thereon in all respects to the satisfaction of the Director. For the purposes of this Special Condition, the expression "Grantee" shall mean the owner of the Commercial Accommodation (as defined in Special Condition No. (48)(b) hereof).
- (c) Without prejudice to the generality of sub-clause (b) of this Special Condition, the Grantee

shall upon completion of construction of the Public Open Space and throughout the term hereby agreed to be granted:

- (i) keep the Public Open Space open 24 hours a day for the use and enjoyment by all members of the public at all times free of charge without any interruption; and
- (ii) at his own expense and to the satisfaction of the Director display notice in prominent location informing the public that the Public Open Space is open to the public and setting out the opening hours and such other relevant information as may be required from time to time by the Director.”

Relevant provisions of the deed of mutual covenant:

Definition of “Commercial Development” in PDMC

“ “Commercial Development” means the Commercial Accommodation as defined in Special Condition No.(48)(b) of the Government Grant constructed or to be constructed within Site C in accordance with Approved Plans for commercial and/or retail use and accommodation ancillary thereto, and for the avoidance of doubt, includes the Public Open Space (as defined in Special Condition No.(43)(a) of the Government Grant), the spaces for parking of motor vehicles and motor cycles belonging to the occupiers of the Commercial Development and their bona fide guests, visitors and invitees, part of the covered pedestrian walkway provided under Special Condition No.(59)(c) of the Government Grant, the spaces for loading and unloading of goods vehicles designated for use by the Commercial Development and the associated driveways and circulation areas, all structural columns within and appertaining to the Commercial Development and as more particularly described in the Sub-Deed of Mutual Covenant or the Sub-Sub-Deed of Mutual Covenant to be executed in respect of Site C.”

Clause 4(b) of Part II of the Second Schedule to PDMC

“Subject to the terms of the Government Grant and the rights, easements and privileges of FSI as the Owner of the Government Accommodation under the Government Grant, this Deed and any Sub-Deed of Mutual Covenant or Sub-Sub-Deed of Mutual Covenant or Deed Poll, the rights for all members of the public

- (b) to use and enjoy the Public Open Space provided under Special Condition No.(43)(a) of the Government Grant 24 hours a day free of charge without any interruption;

PROVIDED THAT the exercise of such rights by the members of the public shall not in any way adversely affect or prejudice the rights, easements and privileges reserved to FSI as the Owner of the Government Accommodation under the Government Grant, this Deed and any Sub-Deed of Mutual Covenant or Sub-Sub-Deed of Mutual Covenant or Deed Poll.”

6. Pedestrian Walkway

Relevant provisions of the land grant:

Special Condition No.(59) (c), (d) and (e)

- “ (c) The Grantee shall, on or before the 30th day of June 2026 or the expiry of 96 months from the Due Date or, if applicable, the Extended Due Date of Site C, whichever is the later or such other date or period as may be determined by the Director, at his own expense and in all respects to the satisfaction of the Director provide a covered pedestrian walkway within the lot with a width of 4 metres so as to link up the Wong Chuk Hang Station, the Government Accommodation, the Existing Footbridge, the public transport facilities underneath the Wong Chuk Hang Station, the public bus terminus along Nam Long Shan Road, the public minibus terminus along Police School Road and the future footbridge (the connection points of which are as shown and marked between points U3 and V3 on Plan Ia annexed hereto). For the avoidance of doubt, the Director may at its absolute discretion allow the portion of the pedestrian walkway between the public bus terminus along Nam Long Shan Road and the public minibus terminus along, Police School Road to be erected at such other positions as may be determined by the Director or with such other widths as may be determined by the Director.
- (d) The Grantee shall throughout the term hereby agreed to be granted maintain at his own expense the segregated pedestrian ways or paths (together with such stairs, ramps, lightings and escalators) and the pedestrian walkway required to be provided under sub-clauses (a) and (c) of this Special Condition in good and substantial condition and repair to the satisfaction of the Director.
- (e) The Grantee shall throughout the term hereby agreed to be granted keep the covered pedestrian walkway required to be provided under sub-clause (d) of this Special Condition open for the use by the public 24 hours a day free of charge without any interruption.”

Relevant provisions of the deed of mutual covenant:

Definition of “Estate Common Areas” in PDMC

“ “Estate Common Areas” means those parts of the Estate which are intended for use by Owners of more than one Phase and not for the sole benefit of any Owner, group of Owners or Owners of a particular Phase including, but not limited to, the Utility Trenches, the Future Footbridge Associated Structures (as defined in Special Condition No.(12)(b) of the Government Grant), the Passage Area, such part of the Pedestrian Link located outside the Land (which are included in this definition solely for management and maintenance purposes), part of the covered pedestrian walkway provided under Special Condition No.(59)(c) of the Government Grant (which solely for management and maintenance purposes, including those part of the covered pedestrian walkway located outside the Land), parapet walls, structural walls and columns, the foundations and other structural elements of the buildings erected on the Estate serving more than one Phase (but excluding those forming part of the Station or the Depot), common estate roads, and all other communal areas within the Estate not used for the sole benefit of any Owner, group of Owners or Owners of a particular Phase (but excluding those areas forming parts of the Residential Development Common Areas or the Common Areas of a particular Phase as designated or to be designated in the Sub-Deed of Mutual Covenant or Sub-Sub-Deed of Mutual Covenant or Deed Poll to be executed in connection with such Phase). The Estate Common Areas shall be more particularly identified on plans to be annexed to any Sub-Deed of Mutual Covenant or Sub-Sub-Deed of Mutual Covenant or Deed Poll to be executed in connection with any Phase.”

Definitions of “Estate Common Areas in Phase 2” and “Pedestrian Walkway in Phase 2” in SDMC

“ “Estate Common Areas in Phase 2” means those parts of the Estate Common Areas situated within Phase 2 which are intended for use by Owners of the Estate and not for the sole benefit of any Owner, group of Owners or Owners of a particular Phase including, but not limited to the Future Footbridge Associated Structures (as defined in Special Condition No.(12)(b) of the Government Grant), the Pedestrian Walkway in Phase 2 (including those parts provided or to be provided adjacent to Site B but outside the Land solely for management and maintenance purposes), part of the Phase 2 Greenery Areas, planters, fireman’s lift lobbies, accessible lift, hose reels, electrical duct, fire shutter, corridors, staircases and landings, parapet walls, structural walls and columns, the foundations and other structural elements of the buildings erected on the Estate serving more than one Phase and within Site B (but excluding those forming part of the Station or the Depot), but excluding the Residential Development Common Areas in Phase 2, the Phase 2 Common Areas, the Phase 2 Residential Common Areas and the Phase 2 Car Park Common Areas; and the Estate Common Areas in Phase 2 are for the purpose of identification shown coloured Indigo, Indigo Cross-hatched Black and Indigo Cross-hatched Black Stippled Black on the plans certified as to their accuracy by the Authorized Person and annexed hereto.”

“ “Pedestrian Walkway in Phase 2” means those parts of the covered pedestrian walkway provided or to be provided in Site B and those parts of the covered pedestrian walkway provided or to be provided adjacent to Site B but outside the Land (which are included herein solely for management and maintenance purposes) pursuant to Special Condition No.(59)(c) of the Government Grant, which are for the purpose of identification as shown coloured Indigo Cross-hatched Black and Indigo Cross-hatched Black Stippled Black on the plans certified as to their accuracy by the Authorized Person and annexed hereto.”

Clause 2(b) of Part II of the Second Schedule to PDMC

“The rights for the Manager with or without surveyors workmen and others to carry out all necessary works required by the Director for the temporary closure of any opening in the building or buildings (excluding the Government Accommodation) erected on the Land so as to enable the connection of pedestrian passageways, subways or footbridges to the buildings erected on the Land or the Future Footbridge Associated Structures (as defined in Special Condition No.(12)(b) of the Government Grant) pursuant to the provisions of Special Condition No.(12) of the Government Grant or the Pedestrian Link and the covered pedestrian walkway (as referred to in Special Condition No.(59)(c) of the Government Grant) or such other structures or buildings outside the Land as may be required under the Government Grant. The Manager in pursuance of any such works shall notify the Owners in writing as to the areas or parts of the Land and the Development which the Owners may not use while such works are being carried out and the Owners shall comply with the requirements of such notification PROVIDED THAT the ingress to or egress from the Government Accommodation shall not be interrupted and the proper use and enjoyment of the Government Accommodation shall not be affected.”

Clause 4(c) of Part II of the Second Schedule to PDMC

“Subject to the terms of the Government Grant and the rights, easements and privileges of FSI as the Owner of the Government Accommodation under the Government Grant, this Deed and any Sub-Deed of Mutual Covenant or Sub-Sub-Deed of Mutual Covenant or Deed Poll, the rights for all members of the public

(c) to use the covered pedestrian walkway provided under Special Condition No.(59)(c) of the Government Grant 24 hours a day free of charge without any interruption; and

PROVIDED THAT the exercise of such rights by the members of the public shall not in any way adversely affect or prejudice the rights, easements and privileges reserved to FSI as the Owner of the Government Accommodation under the Government Grant, this Deed and any Sub-Deed of Mutual Covenant or Sub-Sub-Deed of Mutual Covenant or Deed Poll.”

Clause 3(b) of Part II of the Second Schedule to SDMC

“Without prejudice to the generality of the rights reserved to MTR in Clause 3 of Part II of the Second Schedule to the Principal Deed:-

(b) the right for MTR with all necessary tools, equipment, plant and materials with or without servants, workmen and others at all reasonable times on reasonable prior written notice (except in case of emergency) to enter into and upon any part or parts of Site B (other than the Units sold or assigned by MTR) for the purpose of providing, constructing and maintaining the Pedestrian Walkway in Phase 2 at such point or points or part or parts of Site B as it may require from time to time causing as little disturbance as possible and making good any damage caused thereby.”

7. Passage Area

Relevant provisions of the land grant:

Special Condition No.(61)(a)-(f) and (h)

“ (a) Except with the prior written consent of the Director, no building or structure or support for any building or structure except the structures existing as at the date of this Agreement may be erected or constructed within the area of the lot shown coloured (i) pink stippled orange on Plan Ia annexed hereto unless a clear space extending upwards from the ground level or levels thereof to a height of 5.5 metres and (ii) pink hatched brown stippled orange on Plan Ia annexed hereto unless a clear space extending upwards from the ground level or levels thereof to a height of 3.0 metres are provided for public pedestrian passage purpose (which clear spaces in the said pink stippled orange area and the said pink hatched brown stippled orange area are hereinafter collectively referred to as "the Passage Area").

(b) The Grantee shall on or before the 30th day of June 2027 or the expiry of 84 months from the Due Date or, if applicable, the Extended Due Date of Site F, whichever is the later or such other date or period as may be approved by the Director, at his own expense and in all respects to the satisfaction of the Director lay, form, provide, construct, surface and landscape the Passage Area in such manner with such materials and to such standards, levels, alignment and design as the Director shall approve including installation of street lights, planting of such shrubs and trees and provision and construction of such pavements or such other structures as the Director may require so that the Passage Area may be used for public pedestrian passage.

(c) Upon completion of the works referred to in sub-clause (b) of this Special Condition, the Grantee shall throughout the term hereby agreed to be granted permit all members of the public at all times and for all lawful purposes freely and without payment of any nature whatsoever to pass and repass on foot or by wheelchair over the Passage Area.

(d) Subject to sub-clause (b) of this Special Condition, the Grantee shall not carry out any work which may in the opinion of the Director (whose opinion shall be final and binding on the Grantee) affect the Passage Area.

(e) The Passage Area shall not be used for any purpose other than for the passage of all members of the public on foot or by wheelchair.

(f) The Grantee shall throughout the term hereby agreed to be granted at his own expense maintain the Passage Area in good and substantial repair and condition and keep the same clean and tidy in all respects to the satisfaction of the Director.

(h) The Grantee shall throughout the term hereby agreed to be granted at all times permit the Government, its officers, agents, contractors, workmen or other duly authorized personnel with or without tools, equipment, plants, machinery or motor vehicles, the right of ingress, egress and regress to, from and through the lot or any part or parts thereof and any building or buildings erected or to be erected thereon for the purpose of inspecting, checking and supervising any works to be carried out by the Grantee under sub-clauses (b) and (f) of this Special Condition and the carrying out, inspecting, checking and supervising of the works under sub-clause (g) of this Special Condition.”

Relevant provisions of the deed of mutual covenant:

Definitions of “Estate Common Areas” and “Passage Area” in PDMC

“ “Estate Common Areas” means those parts of the Estate which are intended for use by Owners of more than one Phase and not for the sole benefit of any Owner, group of Owners or Owners of a particular Phase including, but not limited to, the Utility Trenches, the Future Footbridge Associated Structures (as defined in Special Condition No.(12)(b) of the Government Grant), the Passage Area, such part of the Pedestrian Link located outside the Land (which are included in this definition solely for management and maintenance purposes), part of the covered pedestrian walkway provided under Special Condition No.(59)(c) of the Government Grant (which solely for management and maintenance purposes, including those part of the covered pedestrian walkway located outside the Land), parapet walls, structural walls and columns, the foundations and other structural elements of the buildings erected on the Estate serving more than one Phase (but excluding those forming part of the Station or the Depot), common estate roads, and all other communal areas within the Estate not used for the sole benefit of any Owner, group of Owners or Owners of a particular Phase (but excluding those areas forming parts of the Residential Development Common Areas or the Common Areas of a particular Phase as designated or to be designated in the Sub-Deed of Mutual Covenant or Sub-Sub-Deed of Mutual Covenant or Deed Poll to be executed in connection with such Phase). The Estate Common Areas shall be more particularly identified on plans to be annexed to any Sub-Deed of Mutual Covenant or Sub-Sub-Deed of Mutual Covenant or Deed Poll to be executed in connection with any Phase.”

“ “Passage Area” means the Passage Area as defined in Special Condition No.(61)(a) of the Government Grant.”

Clause 4(d) of Part II of the Second Schedule to PDMC

“Subject to the terms of the Government Grant and the rights, easements and privileges of FSI as the Owner of the Government Accommodation under the Government Grant, this Deed and any Sub-Deed of Mutual Covenant or Sub-Sub-Deed of Mutual Covenant or Deed Poll, the rights for all members of the public

- (d) to pass and repass on foot or by wheelchair over the Passage Area at all times and for all lawful purposes freely and without payment of any nature whatsoever

PROVIDED THAT the exercise of such rights by the members of the public shall not in any way adversely affect or prejudice the rights, easements and privileges reserved to FSI as the Owner of the Government Accommodation under the Government Grant, this Deed and any Sub-Deed of Mutual Covenant or Sub-Sub-Deed of Mutual Covenant or Deed Poll.”

B. Facilities that are required under the land grant to be managed, operated or maintained for public use at the expense of the owners of the residential properties in the Phase

1. Existing utilities and railway related structures within the First Reserved Area

Relevant provisions of the land grant:

Special Condition No.(11)(a) and (b)

- “ (a) It is hereby acknowledged that the Grantee has erected existing utilities and railway related structures within the First Reserved Area and shall maintain, repair and replace the existing utilities and railway related structures at his own expense and in all respects to the satisfaction of the Director.
- (b) Upon expiry of the term hereby agreed to be granted and upon request by the Director, the Grantee shall at his own expense and within such time to be specified by the Director in writing demolish and remove all the existing utilities and railway related structures specified in sub-clause (a) of this Special Condition.”

Relevant provisions of the deed of mutual covenant:

Clause 8(b) of Section E of PDMC

“MTR as Owner of the Station and the Depot shall be responsible at its own costs and expenses to maintain, repair and replace the existing utilities and railway related structures within the First Reserved Area (as defined in Special Condition No.(10)(a) of the Government Grant) in all respects to the satisfaction of the Director in accordance with Special Condition No.(11)(a) of the Government Grant.”

2. Footbridge Associated Structures and Future Footbridge Associated Structures

Relevant provisions of the land grant:

Special Condition No.(12)(a), (b), (e), (f) and (g)

- “ (a) The Grantee has at the date of this Agreement at his own expense erected, provided and constructed within the lot columns and other structural supports and connections (which columns and other structural supports and connections are hereinafter collectively referred to as "the Footbridge Associated Structures") for linking the lot to the existing footbridge as shown and marked "EW" on Plan Ia annexed hereto (hereinafter referred to as "the Existing Footbridge") with a minimum clear internal width of 3.0 metres and a clear internal headroom of 2.4 metres and a minimum vertical clearance between the level of 11.7 metres above the HKPD and the level of 18.6 metres above the HKPD located at the positions shown and marked through the points U1 and V1 on Plan Ia annexed hereto. The Grantee shall thereafter manage and maintain at his own expense the Footbridge Associated Structures in all respects to the satisfaction of the Director.
- (b) The Grantee shall on or before the 30th day of June 2026 or the expiry of 96 months from the Due Date or, if applicable, the Extended Due Date of Site C, whichever is the later or such other date or period as may be approved by the Director at his own expense and in all respects to the satisfaction of the Director erect, provide and construct within the lot the columns and such other structural supports and connections as may be required by the Director (which columns and such other structural supports and connections are hereinafter collectively referred to as "the Future Footbridge Associated Structures") with such materials and to such standards, levels, alignment, disposition and designs as may be required or approved by the Director and thereafter manage and maintain at his own expense the Future Footbridge Associated Structures for linking the lot to a future footbridge with such minimum clear internal width, such clear internal headroom and such minimum vertical clearance between such levels all to be determined by the Director which may be located at a position between the points U3 and V3 as shown and marked on Plan Ia annexed hereto or at such other locations and through such other points as may be approved in writing by the Director. For the avoidance of doubt, there is no guarantee that the future footbridge will be constructed.
- (e) Throughout the term hereby agreed to be granted, there is reserved unto the Government, its officers, contractors, agents, workmen, employees and other duly authorized personnel with or without tools, equipment, plant, machinery or vehicles free of all costs charges and expenses the right to enter into, upon and through the lot or any part or parts thereof and in, under, through, on or over any building or buildings or any part thereof erected thereon at all times:
- (i) to carry out works for the purposes of connecting the future footbridge to the Future Footbridge Associated Structures (which connection works are hereinafter referred to as "the Connections") and thereafter to enjoy the easement of support of the Connections and the Existing Footbridge and the future footbridge; and
- (ii) to repair and maintain the Connections and the Existing Footbridge and the future footbridge.

The Government, its officers, contractors, agents, workmen and employees shall have no liability in respect of any loss, damage, nuisance or disturbance whatsoever caused to or suffered by the Grantee arising out of or incidental to the exercise by it or them of the rights conferred under this sub-clause, and no claim shall be made against it or them by the Grantee in respect of any such loss, damage, nuisance or disturbance.

- (f) When called upon to do so by the Director, the Grantee shall at his own expense and in all respects to the satisfaction of the Director execute all necessary works as shall be required or approved by the Director for the temporary closure of any opening in the building or buildings erected or to be erected on the lot so as to enable the Existing Footbridge and the future footbridge to be connected thereto. All necessary maintenance works for the temporary closure shall be the responsibility of the Grantee and shall be carried out at his own expense to the satisfaction of the Director.
- (g) The Grantee has at the date of this Agreement provided and shall throughout the term hereby agreed to be granted keep at his own expense and in all respects to the satisfaction of the Director a public pedestrian access open for use by the public free of charge and without any interruption so as to link up the Existing Footbridge at such location between the points U1 and V1 shown and marked on Plan Ia annexed hereto and the ground level at such location between the points through U2 and V2 shown and marked on Plan Ia annexed hereto during the operational hours of the Wong Chuk Hang Station as defined in Special Condition No. (46) (a) hereof.”

Relevant provisions of the deed of mutual covenant:

Definitions of “Estate Common Areas” and “Station” in PDMC

““Estate Common Areas” means those parts of the Estate which are intended for use by Owners of more than one Phase and not for the sole benefit of any Owner, group of Owners or Owners of a particular Phase including, but not limited to, the Utility Trenches, the Future Footbridge Associated Structures (as defined in Special Condition No.(12)(b) of the Government Grant), the Passage Area, such part of the Pedestrian Link located outside the Land (which are included in this definition solely for management and maintenance purposes), part of the covered pedestrian walkway provided under Special Condition No.(59)(c) of the Government Grant (which solely for management and maintenance purposes, including those part of the covered pedestrian walkway located outside the Land), parapet walls, structural walls and columns, the foundations and other structural elements of the buildings erected on the Estate serving more than one Phase (but excluding those forming part of the Station or the Depot), common estate roads, and all other communal areas within the Estate not used for the sole benefit of any Owner, group of Owners or Owners of a particular Phase (but excluding those areas forming parts of the Residential Development Common Areas or the Common Areas of a particular Phase as designated or to be designated in the Sub-Deed of Mutual Covenant or Sub-Sub-Deed of Mutual Covenant or Deed Poll to be executed in connection with such Phase). The Estate Common Areas shall be more particularly identified on plans to be annexed to any Sub-Deed of Mutual Covenant or Sub-Sub-Deed of Mutual Covenant or Deed Poll to be executed in connection with any Phase.”

““Station” means (i) the Wong Chuk Hang Station (as defined in Special Condition No.(46)(a) of the Government Grant) constructed on or within the Wong Chuk Hang Station Site (as defined in Special Condition No.(1)(h) of the Government Grant) of the Land comprising a railway station and ancillary

railway structures, facilities and roads, (ii) the spaces provided or to be provided within the Wong Chuk Hang Station Site for the parking, manoeuvring, loading and unloading of motor vehicles for the operational needs of the Wong Chuk Hang Station as referred to in Special Condition No.(70) of the Government Grant and (iii) the Footbridge Associated Structures (as defined in Special Condition No.(12)(a) of the Government Grant); for the avoidance of doubt, the following shall not form part of the Station: all utilities, services, trenches, pits and facilities which serve the Depot or the Estate or any part thereof, and all finishes of the Depot and the Estate.”

Definition of “Estate Common Areas in Phase 2” in SDMC

““Estate Common Areas in Phase 2” means those parts of the Estate Common Areas situated within Phase 2 which are intended for use by Owners of the Estate and not for the sole benefit of any Owner, group of Owners or Owners of a particular Phase including, but not limited to the Future Footbridge Associated Structures (as defined in Special Condition No.(12)(b) of the Government Grant), the Pedestrian Walkway in Phase 2 (including those parts provided or to be provided adjacent to Site B but outside the Land solely for management and maintenance purposes), part of the Phase 2 Greenery Areas, planters, fireman’s lift lobbies, accessible lift, hose reels, electrical duct, fire shutter, corridors, staircases and landings, parapet walls, structural walls and columns, the foundations and other structural elements of the buildings erected on the Estate serving more than one Phase and within Site B (but excluding those forming part of the Station or the Depot), but excluding the Residential Development Common Areas in Phase 2, the Phase 2 Common Areas, the Phase 2 Residential Common Areas and the Phase 2 Car Park Common Areas; and the Estate Common Areas in Phase 2 are for the purpose of identification shown coloured Indigo, Indigo Cross-hatched Black and Indigo Cross-hatched Black Stippled Black on the plans certified as to their accuracy by the Authorized Person and annexed hereto.”

Clause 8(c) of Section E of PDMC

“MTR as Owner of the Station and the Depot shall be responsible to provide and keep at its own expenses and in all respects to the satisfaction of the Director the public pedestrian access as required under Special Condition No.(12)(g) of the Government Grant open for use by the public free of charge and without any interruption during the operational hours of the Wong Chuk Hang Station (as defined in Special Condition No.(46)(a) of the Government Grant).”

Clause 2(b) of Part II of the Second Schedule to PDMC

“The rights for the Manager with or without surveyors workmen and others to carry out all necessary works required by the Director for the temporary closure of any opening in the building or buildings (excluding the Government Accommodation) erected on the Land so as to enable the connection of pedestrian passageways, subways or footbridges to the buildings erected on the Land or the Future Footbridge Associated Structures (as defined in Special Condition No.(12)(b) of the Government Grant) pursuant to the provisions of Special Condition No.(12) of the Government Grant or the Pedestrian Link and the covered pedestrian walkway (as referred to in Special Condition No.(59)(c) of the Government Grant) or such other structures or buildings outside the Land as may be required under the Government Grant. The Manager in pursuance of any such works shall notify the Owners in writing as to the areas or parts of the Land and the Development which the Owners may not use while such works are being carried out and the Owners shall comply with the requirements of such notification PROVIDED THAT the ingress to or egress from the Government Accommodation shall not be interrupted and the proper use and enjoyment of the Government Accommodation shall not be affected.”

Clause 4(a) of Part II of the Second Schedule to PDMC

“Subject to the terms of the Government Grant and the rights, easements and privileges of FSI as the Owner of the Government Accommodation under the Government Grant, this Deed and any Sub-Deed of Mutual Covenant or Sub-Sub-Deed of Mutual Covenant or Deed Poll, the rights for all members of the public

- (a) to use the public pedestrian access provided by MTR under Special Condition No.(12)(g) of the Government Grant during the operational hours of the Wong Chuk Hang Station as defined in Special Condition No.(46)(a) of the Government Grant;

PROVIDED THAT the exercise of such rights by the members of the public shall not in any way adversely affect or prejudice the rights, easements and privileges reserved to FSI as the Owner of the Government Accommodation under the Government Grant, this Deed and any Sub-Deed of Mutual Covenant or Sub-Sub-Deed of Mutual Covenant or Deed Poll.”

Clause 3(a) of Part II of the Second Schedule to SDMC

“Without prejudice to the generality of the rights reserved to MTR in Clause 3 of Part II of the Second Schedule to the Principal Deed :-

- (a) the right for MTR with all necessary tools, equipment, plant and materials with or without servants, workmen and others at all reasonable times on reasonable prior written notice (except in case of emergency) to enter into and upon any part or parts of Site B (other than the Units sold or assigned by MTR) for the purpose of erecting, providing and constructing footbridges, columns, structural supports and connections including but not limited to the Future Footbridge Associated Structures (as defined in Special Condition No.(12)(b) of the Government Grant) at such point or points or part or parts of Site B as it may require from time to time causing as little disturbance as possible and making good any damage caused thereby.”

3. Green Area and Structures

Relevant provisions of the land grant:

Special Condition No.(13)(a)

“ (a) The Grantee shall:

- (i) on or before the 31st day of March 2026 or the expiry of 84 months from the Due Date or, if applicable, the Extended Due Date of Site D, whichever is the later or such other date or period as may be approved by the Director, at his own expense, in such manner with such materials and to such standards, levels, alignment and design as the Director shall approve and in all respects to the satisfaction of the Director:

- (I) lay and form those portions of future public roads shown coloured green on Plan Ia annexed hereto (hereinafter referred to as "the Green Area"); and

- (II) provide and construct such bridges, tunnels, over-passes, under-passes, culverts, viaducts, flyovers, pavements, roads or such other structures as the Director in his sole discretion may require (hereinafter collectively referred to as "the Structures") so that building, vehicular and pedestrian traffic may be carried on the Green Area.

- (ii) on or before the 31st day of March 2026 or the expiry of 84 months from the Due Date or, if applicable, the Extended Due Date of Site D, whichever is the later or such other date or period as may be approved by the Director, at his own expense and to the satisfaction of the Director, surface, kerb and channel the Green Area and provide the same with such gullies, sewers, drains, fire hydrants with pipes connected to water mains, services, street lights, traffic signs, street furniture and road markings and plant as the Director may require; and

- (iii) maintain at his own expense the Green Area together with the Structures and all structures, surfaces, gullies, sewers, drains, fire hydrants, services, street lights, traffic signs, street furniture, road markings and plant, constructed, installed and provided thereon or therein to the satisfaction of the Director until such time as possession of the Green Area shall have been re-delivered in accordance with Special Condition No. (14) hereof.”

Special Condition No.(14)

“For the purpose only of carrying out the necessary works specified in Special Condition No. (13) hereof, the Grantee shall on the date of this Agreement be granted possession of the Green Area. The Green Area shall be re-delivered to the Government on demand and in any event shall be deemed to have been re-delivered to the Government by the Grantee on the date of a letter from the Director indicating that these Conditions have been complied with to his satisfaction. The Grantee shall at all reasonable times while he is in possession of the Green Area allow free access over and along the Green Area for all Government and public vehicular and pedestrian traffic and shall ensure that such access shall not be interfered with or obstructed by the carrying out of the works whether under Special Condition No. (13) hereof or otherwise.”

Special Condition No.(15)

“The Grantee shall not without the prior written consent of the Director use the Green Area for the purpose of storage or for the erection of any temporary structure or for any purposes other than the carrying out of the works specified in Special Condition No. (13) hereof.”

Special Condition No.(16)

“The Grantee shall at all reasonable times while he is in possession of the Green Area permit the Government, the Director and his officers, contractors and agents and any persons authorized by the Director, the right of ingress, egress and regress to, from and through the lot and the Green Area for the purpose of inspecting, checking and supervising any works to be carried out in compliance with Special Condition No. (13)(a) hereof and the carrying out, inspecting, checking and supervising of the works under Special Condition No. (13)(b) hereof and any other works which the Director may consider necessary in the Green Area.”

Relevant provisions of the deed of mutual covenant:

Definitions of “Green Area” and “Structures” in PDMC

“ “Green Area” means those portions of public roads laid and formed and future public roads to be laid and formed by MTR at the area shown coloured green on Plan Ia annexed to the Government Grant pursuant to Special Condition No.(13)(a)(i)(I) of the Government Grant.”

“ “Structures” means the Structures as defined in Special Condition No.(13)(a)(i)(II) of the Government Grant.”

Clause 1(b) of Section E of PDMC

“For the avoidance of doubt, subject to the provisions in the Government Grant and this Deed, the construction of the Green Area, the Structures, the Stippled Green Area and the Stippled Green Area Structures shall be carried out and the construction costs therefor shall be borne by MTR as the original grantee of the Land under the Government Grant, and upon the completion of the construction of the Green Area, the Structures, the Stippled Green Area and the Stippled Green Area Structures or any part thereof by MTR to the satisfaction of the Director, the Green Area, the Structures, the Stippled Green Area and the Stippled Green Area Structures or such completed part thereof shall be managed and controlled by the Manager in accordance with this Deed until re-delivery to the Government.”

Clause 1 of Section F of PDMC

“Subject to Clause 12 of this Section, from time to time as occasion may require there shall be meetings of the Owners of the Estate to discuss and decide matters concerning the Estate and/or (prior to re-delivery to the Government pursuant to the Government Grant) the Green Area, the Structures, the Stippled Green Area and the Stippled Green Area Structures as hereinafter mentioned and in regard to such meetings the provisions of this Section shall apply. The procedure at a meeting of the Owners of the Estate shall be as is determined by the Owners of the Estate.”

Clause 9(a) of Section F of PDMC

“Any resolution on any matter concerning the Estate and/or the Green Area, the Structures, the Stippled Green Area and the Stippled Green Area Structures, save only those matters referred to in Clause 11 of this Section, passed at a duly convened meeting by a majority vote of the Owners present in person or by proxy and voting shall be binding on all the Owners PROVIDED THAT:

- (i) the notice convening the meeting shall have been duly given and shall have specified the intention to propose a resolution concerning such matter;
- (ii) no resolution purporting to be passed at any such meeting concerning any matter not mentioned in such notice shall be valid;
- (iii) no resolution shall be valid to the extent that it purports to alter or amend the provisions of this Deed or is inconsistent therewith save as herein specifically provided;
- (iv) no resolution shall be valid to the extent that it is in conflict with or contrary to any order

ruling or judgment of the Hong Kong courts or any mandatory provision of any statute;

- (v) no resolution shall have any adverse effect on the use, operation or maintenance of the Government Accommodation or any part thereof or the services and facilities supplying the Government Accommodation;
- (vi) any resolution on matters or issues which in the reasonable opinion of MTR may affect or have an impact on the Mass Transit Railway, the Mass Transit Railway Structures and Installations, the Station or the Depot or any part thereof, shall be subject to the agreement of MTR; and
- (vii) no resolution shall damage, interfere with, obstruct or endanger the construction, use, operation, maintenance or safety of the Mass Transit Railway, the Mass Transit Railway Structures and Installations, the Station or the Depot or any part thereof.”

Clause 1(b)(ii) of Section G of PDMC

“The function of the Development Owners’ Committee shall be to:

- (ii) discuss issues relating to the maintenance and management of the Estate Common Areas, Estate Common Services and Facilities, Residential Development Common Areas, Residential Development Common Services and Facilities, the Green Area, the Structures, the Stippled Green Area and the Stippled Green Area Structures and to make known to the Manager its views;”

Clause 1(a) of Section I of PDMC

“Subject to the provisions of the Ordinance, subject to the rights, easements and privileges of FSI as Owner of the Government Accommodation under this Deed, any Sub-Deed of Mutual Covenant or Sub-Sub-Deed of Mutual Covenant or Deed Poll and the Government Grant and subject to as provided in this Deed, the Manager shall in respect of any part of the Estate in respect of which a Sub-Deed of Mutual Covenant has been entered into pursuant to this Deed (save and except the Government Accommodation) and (before re-delivery to the Government pursuant to the Government Grant) the Green Area, the Structures, the Stippled Green Area and the Stippled Green Area Structures have the authority to do all such acts and things as may be necessary or expedient for the management of the relevant part of the Land and the Estate (save and except the Government Accommodation) and the Green Area, the Structures, the Stippled Green Area and the Stippled Green Area Structures and anything reasonably incidental thereto for and on behalf of all Owners (save and except FSI as the Owner of the Government Accommodation) in accordance with the provisions of this Deed and each Owner of the Estate (save and except FSI as the Owner of the Government Accommodation) irrevocably appoints the Manager as agent in respect of any matter concerning the Common Areas and the Common Services and Facilities and all other matters duly authorized under this Deed or any Sub-Deed of Mutual Covenant or Sub-Sub-Deed of Mutual Covenant.”

Clause 2 of Section I of PDMC

“Subject to the Ordinance and the provisions of this Deed, the Common Areas, the Common Services and Facilities and (before re-delivery to the Government pursuant to the Government Grant) the Green Area, the Structures, the Stippled Green Area and the Stippled Green Area Structures shall be under the exclusive control of the Manager.”

Clause 4(b) of Section I of PDMC

“The Manager, or in the absence of the Manager, the Owners’ Corporation or the Chairman of the Development Owners’ Committee, shall have the power to accept service of notice and demand by the Government for delivery of possession of the Green Area, the Structures, the Stippled Green Area and/or the Stippled Green Area Structures or any part thereof and deliver the Green Area, the Structures, the Stippled Green Area and/or the Stippled Green Area Structures or any part thereof to the Government pursuant to the Government Grant for and on behalf of all the Owners of the Land.”

Clause 5(b)(II) of Section J of PDMC

“Notwithstanding anything contained in this Deed to the contrary, the Owner of the Station and the Depot shall share, and contribute to, (i) the costs and expenses of the Estate Common Areas and Facilities Management Sub-Budget in so far as the same is attributable to the maintenance and management of the Green Area, the Structures, the Stippled Green Area, the Stippled Green Area Structures and the Passage Area but not otherwise and (ii) the expenditure for major works of a capital nature or of a kind not expected to be incurred annually in respect of the Green Area, the Structures, the Stippled Green Area, the Stippled Green Area Structures and the Passage Area but not otherwise in the proportion that the construction gross floor area of the Station and the Depot bears to the total of the construction gross floor area of the Station and the Depot and the construction gross floor areas of all those parts of the Estate which have been completed for the time being (“the Construction GFA of the Completed Estate”). The Manager shall prepare a sub-sub-budget under the Estate Common Areas and Facilities Management Sub-Budget showing the estimated annual costs and expenses for the management and maintenance of the Green Area, the Structures, the Stippled Green Area, the Stippled Green Area Structures and the Passage Area and such expenditure for major works of a capital nature or of a kind not expected to be incurred annually in respect of the Green Area, the Structures, the Stippled Green Area, the Stippled Green Area Structures and the Passage Area for the ensuing year and a copy of such sub-budget shall be sent to the Owner of the Station and the Depot for its information. For the purpose of this sub-clause, the construction gross floor area of the Station and the Depot is 53,726 m² and the “Construction GFA of the Completed Estate” shall mean the actual gross floor area of the completed part(s) of the Estate irrespective of whether that gross floor area is accountable or non-accountable under the Buildings Ordinance or the Government Grant as certified by the authorized person(s) for the Estate or the relevant Phase.”

4. Stippled Green Area and Stippled Green Area Structures

Relevant provisions of the land grant:

Special Condition No.(17)(a)

“ (a) The Grantee shall:

- (i) on or before the 30th day of June 2026 or the expiry of 96 months from the Due Date or, if applicable, the Extended Due Date of Site C, whichever is the later or such other date or period as may be approved by the Director, at his own expense, in such manner with such materials and to such standards, levels, alignment and design as the Director shall approve and in all respects to the satisfaction of the Director:

- (I) lay and form those portions of future public roads in the air stratum shown coloured stippled green on Plan Ia annexed hereto between the level of 2 metres below the ground, level or levels and the level of 5.5 metres above the ground level or levels (hereinafter referred to as "the Stippled Green Area"). For the avoidance of doubt, the air stratum of the Stippled Green Area and the Fifth Reserved Area are the same; and
 - (II) provide and construct such bridges, tunnels, over-passes, under-passes, culverts, viaducts, flyovers, pavements, roads or such other - structures as the Director in his sole discretion may require (hereinafter collectively referred to as "the Stippled Green Area Structures") so that building, vehicular and pedestrian traffic may be carried on the Stippled Green Area;
- (ii) on or before the 30th day of June 2026 or the expiry of 96 months from the Due Date or, if applicable, the Extended Due Date of Site C, whichever is the later or such other date or period as may be approved by the , Director, at his own expense and to the satisfaction of the Director, surface, kerb and channel the Stippled Green Area and provide the same with such gullies, sewers, drains, fire hydrants with pipes connected to water mains, services, street lights, traffic signs, street furniture and road markings and plant as the Director may require; and
 - (iii) maintain at his own expense the Stippled Green Area together with the Stippled Green Area Structures and all structures, surfaces, gullies, sewers, drains, fire hydrants, services, street lights, traffic signs, street furniture, road markings and plant constructed, installed and provided thereon or therein to the satisfaction of the Director until such time as possession of the Stippled Green Area shall have been re-delivered in accordance with Special Condition No. (18) hereof.”

Special Condition No.(18)

“For the purpose only of carrying out the necessary works specified in Special Condition No. (17) hereof, the Grantee shall on the date of this Agreement be granted possession of the Stippled Green Area. The Stippled Green Area shall be re-delivered to the Government on demand and in any event shall be deemed to have been re-delivered to the Government by the Grantee on the date of a letter from the Director indicating that these Conditions have been complied with to his satisfaction. The Grantee shall at all reasonable times while he is in possession of the Stippled Green Area allow free access over and along the Stippled Green Area for all Government and public vehicular and pedestrian traffic and shall ensure that such access shall not be interfered with or obstructed by the carrying out of the works whether under Special Condition No. (17) hereof or otherwise.”

Special Condition No.(19)

“The Grantee shall not without the prior written consent of the Director use the Stippled Green Area for the purpose of storage or for the erection of any temporary structure or for any purposes other than the carrying out of the works specified in Special Condition No. (17) hereof.”

Special Condition No.(20)

“The Grantee shall at all reasonable times while he is in possession of the Stippled Green Area permit the Government, the Director and his officers, contractors and agents and any persons authorized by the Director, the right of ingress, egress and regress to, from and through the lot and the Stippled Green Area for the purpose of inspecting, checking and supervising any works to be carried out in compliance with Special Condition No. (17)(a) hereof and the carrying out, inspecting, checking and supervising of the works under Special Condition No. (17)(b) hereof and any other works which the Director may consider necessary in the Stippled Green Area.”

Relevant provisions of the deed of mutual covenant:

Definitions of “Stippled Green Area” and “Stippled Green Area Structures” in PDMC

“ “Stippled Green Area” means those portions of public roads laid and formed and future public roads to be laid and formed by MTR in the air stratum shown coloured stippled green on Plan Ia annexed to the Government Grant between the level of 2 metres below the ground level or levels and the level of 5.5 metres above the ground level or levels pursuant to in Special Condition No.(17)(a)(i)(I) of the Government Grant.”

“ “Stippled Green Area Structures” means the Stippled Green Area Structures as defined in Special Condition No.(17)(a)(i)(II) of the Government Grant.”

Clause 1(b) of Section E of PDMC

“For the avoidance of doubt, subject to the provisions in the Government Grant and this Deed, the construction of the Green Area, the Structures, the Stippled Green Area and the Stippled Green Area Structures shall be carried out and the construction costs therefor shall be borne by MTR as the original grantee of the Land under the Government Grant, and upon the completion of the construction of the Green Area, the Structures, the Stippled Green Area and the Stippled Green Area Structures or any part thereof by MTR to the satisfaction of the Director, the Green Area, the Structures, the Stippled Green Area and the Stippled Green Area Structures or such completed part thereof shall be managed and controlled by the Manager in accordance with this Deed until re-delivery to the Government.”

Clause 1 of Section F of PDMC

“Subject to Clause 12 of this Section, from time to time as occasion may require there shall be meetings of the Owners of the Estate to discuss and decide matters concerning the Estate and/or (prior to re-delivery to the Government pursuant to the Government Grant) the Green Area, the Structures, the Stippled Green Area and the Stippled Green Area Structures as hereinafter mentioned and in regard to such meetings the provisions of this Section shall apply. The procedure at a meeting of the Owners of the Estate shall be as is determined by the Owners of the Estate.”

Clause 9(a) of Section F of PDMC

“Any resolution on any matter concerning the Estate and/or the Green Area, the Structures, the Stippled Green Area and the Stippled Green Area Structures, save only those matters referred to in Clause 11 of this Section, passed at a duly convened meeting by a majority vote of the Owners present in person or by proxy and voting shall be binding on all the Owners PROVIDED THAT:

- (i) the notice convening the meeting shall have been duly given and shall have specified the intention to propose a resolution concerning such matter;
- (ii) no resolution purporting to be passed at any such meeting concerning any matter not mentioned in such notice shall be valid;
- (iii) no resolution shall be valid to the extent that it purports to alter or amend the provisions of this Deed or is inconsistent therewith save as herein specifically provided;
- (iv) no resolution shall be valid to the extent that it is in conflict with or contrary to any order ruling or judgment of the Hong Kong courts or any mandatory provision of any statute;
- (v) no resolution shall have any adverse effect on the use, operation or maintenance of the Government Accommodation or any part thereof or the services and facilities supplying the Government Accommodation;
- (vi) any resolution on matters or issues which in the reasonable opinion of MTR may affect or have an impact on the Mass Transit Railway, the Mass Transit Railway Structures and Installations, the Station or the Depot or any part thereof, shall be subject to the agreement of MTR; and
- (vii) no resolution shall damage, interfere with, obstruct or endanger the construction, use, operation, maintenance or safety of the Mass Transit Railway, the Mass Transit Railway Structures and Installations, the Station or the Depot or any part thereof.”

Clause 1(b)(ii) of Section G of PDMC

“The function of the Development Owners’ Committee shall be to:

- (ii) discuss issues relating to the maintenance and management of the Estate Common Areas, Estate Common Services and Facilities, Residential Development Common Areas, Residential Development Common Services and Facilities, the Green Area, the Structures, the Stippled Green Area and the Stippled Green Area Structures and to make known to the Manager its views;”

Clause 1(a) of Section I of PDMC

“Subject to the provisions of the Ordinance, subject to the rights, easements and privileges of FSI as Owner of the Government Accommodation under this Deed, any Sub-Deed of Mutual Covenant or Sub-Sub-Deed of Mutual Covenant or Deed Poll and the Government Grant and subject to as provided in this Deed, the Manager shall in respect of any part of the Estate in respect of which a Sub-Deed of Mutual Covenant has been entered into pursuant to this Deed (save and except the Government Accommodation) and (before re-delivery to the Government pursuant to the Government Grant) the Green Area, the Structures, the Stippled Green Area and the Stippled Green Area Structures have the authority to do all such acts and things as may be necessary or expedient for the management of the relevant part of the Land and the Estate (save and except the Government Accommodation)

and the Green Area, the Structures, the Stippled Green Area and the Stippled Green Area Structures and anything reasonably incidental thereto for and on behalf of all Owners (save and except FSI as the Owner of the Government Accommodation) in accordance with the provisions of this Deed and each Owner of the Estate (save and except FSI as the Owner of the Government Accommodation) irrevocably appoints the Manager as agent in respect of any matter concerning the Common Areas and the Common Services and Facilities and all other matters duly authorized under this Deed or any Sub-Deed of Mutual Covenant or Sub-Sub-Deed of Mutual Covenant.”

Clause 2 of Section I of PDMC

“Subject to the Ordinance and the provisions of this Deed, the Common Areas, the Common Services and Facilities and (before re-delivery to the Government pursuant to the Government Grant) the Green Area, the Structures, the Stippled Green Area and the Stippled Green Area Structures shall be under the exclusive control of the Manager.”

Clause 4(b) of Section I of PDMC

“The Manager, or in the absence of the Manager, the Owners’ Corporation or the Chairman of the Development Owners’ Committee, shall have the power to accept service of notice and demand by the Government for delivery of possession of the Green Area, the Structures, the Stippled Green Area and/or the Stippled Green Area Structures or any part thereof and deliver the Green Area, the Structures, the Stippled Green Area and/or the Stippled Green Area Structures or any part thereof to the Government pursuant to the Government Grant for and on behalf of all the Owners of the Land.”

Clause 5(b)(II) of Section J of PDMC

“Notwithstanding anything contained in this Deed to the contrary, the Owner of the Station and the Depot shall share, and contribute to, (i) the costs and expenses of the Estate Common Areas and Facilities Management Sub-Budget in so far as the same is attributable to the maintenance and management of the Green Area, the Structures, the Stippled Green Area, the Stippled Green Area Structures and the Passage Area but not otherwise and (ii) the expenditure for major works of a capital nature or of a kind not expected to be incurred annually in respect of the Green Area, the Structures, the Stippled Green Area, the Stippled Green Area Structures and the Passage Area but not otherwise in the proportion that the construction gross floor area of the Station and the Depot bears to the total of the construction gross floor area of the Station and the Depot and the construction gross floor areas of all those parts of the Estate which have been completed for the time being (“the Construction GFA of the Completed Estate”). The Manager shall prepare a sub-sub-budget under the Estate Common Areas and Facilities Management Sub-Budget showing the estimated annual costs and expenses for the management and maintenance of the Green Area, the Structures, the Stippled Green Area, the Stippled Green Area Structures and the Passage Area and such expenditure for major works of a capital nature or of a kind not expected to be incurred annually in respect of the Green Area, the Structures, the Stippled Green Area, the Stippled Green Area Structures and the Passage Area for the ensuing year and a copy of such sub-budget shall be sent to the Owner of the Station and the Depot for its information. For the purpose of this sub-clause, the construction gross floor area of the Station and the Depot is 53,726 m² and the “Construction GFA of the Completed Estate” shall mean the actual gross floor area of the completed part(s) of the Estate irrespective of whether that gross floor area is accountable or non-accountable under the Buildings Ordinance or the Government Grant as certified by the authorized person(s) for the Estate or the relevant Phase.”

5. Items

Relevant provisions of the land grant:

Special Condition No.(42)(a), (b) and (c)

- “ (a) The Grantee shall throughout the term hereby agreed to be granted at his own expense but subject to any contribution by F.S.I. as referred to in Special Condition No. (64)(a)(iv)(I) hereof and in all respects to the satisfaction of the Director maintain the following items (hereinafter referred to as "the Items"):
- (i) the external finishes of the Government Accommodation and the structure of all walls, columns, beams, ceilings, roof slabs, carriageway or floor slabs and any other structural elements of, in, around, within, above and below the Government Accommodation;
 - (ii) all lifts, escalators and stairways serving the Government Accommodation and the remainder of the development on the lot;
 - (iii) all building services installations, plant and equipment (including but not limited to portable and non-portable fire services installation equipment) forming part of the system serving the Government Accommodation and the remainder of the development on the lot; and
 - (iv) all other common parts and facilities serving the Government Accommodation and the remainder of the development on the lot.
- (b) The Grantee shall indemnify and keep indemnified the Government and F.S.I. against all liabilities, damages, expenses, claims, costs, demands, charges, actions and proceedings of whatsoever nature arising out of or as a consequence of the failure of the Grantee to maintain the Items.
- (c) For the purpose of this Special Condition only, the expression "Grantee" shall exclude F.S.I.”

Relevant provisions of the deed of mutual covenant:

Definition of “Items” in PDMC

“ “Items” means (i) the external finishes of the Government Accommodation and the structure of all walls, columns, beams, ceilings, roof slabs, carriageway or floor slabs and any other structural elements of, in, around, within, above and below the Government Accommodation; (ii) all lifts, escalators and stairways serving the Government Accommodation and the remainder of the Development; (iii) all building services installations, plant and equipment (including but not limited to portable and non-portable fire services installation equipment) forming part of the system serving the Government Accommodation and the remainder of the Development; and (iv) all other common parts and facilities serving the Government Accommodation and the remainder of the Development as referred to in Special Condition No.(42)(a) of the Government Grant.”

Clause 5 of Section C of PDMC

“A Party Wall shall be repaired and maintained at the joint expense of the Owners of the Units which the Party Wall separates PROVIDED THAT if any part of the Party Wall shall form part of the Items, such part of the Party Wall shall be maintained by the Owners of the Units in Site A (save and except the Owner of the Government Accommodation) in accordance with Clause 9(b) of Section E of this Deed.”

Clause 9(b) of Section E of PDMC

“The Owners of Units in Site A (save and except the Owner of the Government Accommodation) shall, acting by the Manager, be responsible for maintaining, managing and repairing the Items subject to any contribution by FSI under sub-clause (a) of this Clause and shall indemnify FSI and the Government against all actions, proceedings, claims and demands whatsoever arising out of or in respect of any loss or damage to any person or property arising out of or as a consequence of a failure to maintain, manage and repair the Items aforesaid.”

Clause 1(b)(xii) of Section I of PDMC

“Without in any way limiting the generality of the foregoing, the Manager shall have the following powers and duties, namely:

- (xii) Subject to Clause 9(b) of Section E of this Deed, to maintain, manage and keep in good repair and condition the Items.”

6. Pedestrian Walkway

Relevant provisions of the land grant:

Special Condition No.(59) (c), (d) and (e)

- “ (c) The Grantee shall, on or before the 30th day of June 2026 or the expiry of 96 months from the Due Date or, if applicable, the Extended Due Date of Site C, whichever is the later or such other date or period as may be determined by the Director, at his own expense and in all respects to the satisfaction of the Director provide a covered pedestrian walkway within the lot with a width of 4 metres so as to link up the Wong Chuk Hang Station, the Government Accommodation, the Existing Footbridge, the public transport facilities underneath the Wong Chuk Hang Station, the public bus terminus along Nam Long Shan Road, the public minibus terminus along Police School Road and the future footbridge (the connection points of which are as shown and marked between points U3 and V3 on Plan Ia annexed hereto). For the avoidance of doubt, the Director may at its absolute discretion allow the portion of the pedestrian walkway between the public bus terminus along Nam Long Shan Road and the public minibus terminus along, Police School Road to be erected at such other positions as may be determined by the Director or with such other widths as may be determined by the Director.

- (d) The Grantee shall throughout the term hereby agreed to be granted maintain at his own expense the segregated pedestrian ways or paths (together with such stairs, ramps, lightings and escalators) and the pedestrian walkway required to be provided under sub-clauses (a) and (c) of this Special Condition in good and substantial condition and repair to the satisfaction of the Director.
- (e) The Grantee shall throughout the term hereby agreed to be granted keep the covered pedestrian walkway required to be provided under sub-clause (d) of this Special Condition open for the use by the public 24 hours a day free of charge without any interruption.”

Relevant provisions of the deed of mutual covenant:

Definition of “Estate Common Areas” in PDMC

“ “Estate Common Areas” means those parts of the Estate which are intended for use by Owners of more than one Phase and not for the sole benefit of any Owner, group of Owners or Owners of a particular Phase including, but not limited to, the Utility Trenches, the Future Footbridge Associated Structures (as defined in Special Condition No.(12)(b) of the Government Grant), the Passage Area, such part of the Pedestrian Link located outside the Land (which are included in this definition solely for management and maintenance purposes), part of the covered pedestrian walkway provided under Special Condition No.(59)(c) of the Government Grant (which solely for management and maintenance purposes, including those part of the covered pedestrian walkway located outside the Land), parapet walls, structural walls and columns, the foundations and other structural elements of the buildings erected on the Estate serving more than one Phase (but excluding those forming part of the Station or the Depot), common estate roads, and all other communal areas within the Estate not used for the sole benefit of any Owner, group of Owners or Owners of a particular Phase (but excluding those areas forming parts of the Residential Development Common Areas or the Common Areas of a particular Phase as designated or to be designated in the Sub-Deed of Mutual Covenant or Sub-Sub-Deed of Mutual Covenant or Deed Poll to be executed in connection with such Phase). The Estate Common Areas shall be more particularly identified on plans to be annexed to any Sub-Deed of Mutual Covenant or Sub-Sub-Deed of Mutual Covenant or Deed Poll to be executed in connection with any Phase.”

Definitions of “Estate Common Areas in Phase 2” and “Pedestrian Walkway in Phase 2” in SDMC

“ “Estate Common Areas in Phase 2” means those parts of the Estate Common Areas situated within Phase 2 which are intended for use by Owners of the Estate and not for the sole benefit of any Owner, group of Owners or Owners of a particular Phase including, but not limited to the Future Footbridge Associated Structures (as defined in Special Condition No.(12)(b) of the Government Grant), the Pedestrian Walkway in Phase 2 (including those parts provided or to be provided adjacent to Site B but outside the Land solely for management and maintenance purposes), part of the Phase 2 Greenery Areas, planters, fireman’s lift lobbies, accessible lift, hose reels, electrical duct, fire shutter, corridors, staircases and landings, parapet walls, structural walls and columns, the foundations and other structural elements of the buildings erected on the Estate serving more than one Phase and within Site B (but excluding those forming part of the Station or the Depot), but excluding the Residential Development Common Areas in Phase 2, the Phase 2 Common Areas, the Phase 2 Residential Common Areas and the Phase 2 Car Park Common Areas; and the Estate Common Areas in Phase 2 are for the purpose of identification shown coloured Indigo, Indigo Cross-hatched Black and Indigo

Cross-hatched Black Stippled Black on the plans certified as to their accuracy by the Authorized Person and annexed hereto.”

“ “Pedestrian Walkway in Phase 2” means those parts of the covered pedestrian walkway provided or to be provided in Site B and those parts of the covered pedestrian walkway provided or to be provided adjacent to Site B but outside the Land (which are included herein solely for management and maintenance purposes) pursuant to Special Condition No.(59)(c) of the Government Grant, which are for the purpose of identification as shown coloured Indigo Cross-hatched Black and Indigo Cross-hatched Black Stippled Black on the plans certified as to their accuracy by the Authorized Person and annexed hereto.”

Clause 2(b) of Part II of the Second Schedule to PDMC

“The rights for the Manager with or without surveyors workmen and others to carry out all necessary works required by the Director for the temporary closure of any opening in the building or buildings (excluding the Government Accommodation) erected on the Land so as to enable the connection of pedestrian passageways, subways or footbridges to the buildings erected on the Land or the Future Footbridge Associated Structures (as defined in Special Condition No.(12)(b) of the Government Grant) pursuant to the provisions of Special Condition No.(12) of the Government Grant or the Pedestrian Link and the covered pedestrian walkway (as referred to in Special Condition No.(59)(c) of the Government Grant) or such other structures or buildings outside the Land as may be required under the Government Grant. The Manager in pursuance of any such works shall notify the Owners in writing as to the areas or parts of the Land and the Development which the Owners may not use while such works are being carried out and the Owners shall comply with the requirements of such notification PROVIDED THAT the ingress to or egress from the Government Accommodation shall not be interrupted and the proper use and enjoyment of the Government Accommodation shall not be affected.”

Clause 4(c) of Part II of the Second Schedule to PDMC

“Subject to the terms of the Government Grant and the rights, easements and privileges of FSI as the Owner of the Government Accommodation under the Government Grant, this Deed and any Sub-Deed of Mutual Covenant or Sub-Sub-Deed of Mutual Covenant or Deed Poll, the rights for all members of the public

- (c) to use the covered pedestrian walkway provided under Special Condition No.(59)(c) of the Government Grant 24 hours a day free of charge without any interruption; and

PROVIDED THAT the exercise of such rights by the members of the public shall not in any way adversely affect or prejudice the rights, easements and privileges reserved to FSI as the Owner of the Government Accommodation under the Government Grant, this Deed and any Sub-Deed of Mutual Covenant or Sub-Sub-Deed of Mutual Covenant or Deed Poll.”

Clause 3(b) of Part II of the Second Schedule to SDMC

“Without prejudice to the generality of the rights reserved to MTR in Clause 3 of Part II of the Second Schedule to the Principal Deed:-

- (b) the right for MTR with all necessary tools, equipment, plant and materials with or without servants, workmen and others at all reasonable times on reasonable prior written notice (except in case of emergency) to enter into and upon any part or parts of Site B (other than the Units sold or assigned by MTR) for the purpose of providing, constructing and maintaining the Pedestrian Walkway in Phase 2 at such point or points or part or parts of Site B as it may require from time to time causing as little disturbance as possible and making good any damage caused thereby.”

7. Passage Area

Relevant provisions of the land grant:

Special Condition No.(61)(a)-(f) and (h)

- “ (a) Except with the prior written consent of the Director, no building or structure or support for any building or structure except the structures existing as at the date of this Agreement may be erected or constructed within the area of the lot shown coloured (i) pink stippled orange on Plan Ia annexed hereto unless a clear space extending upwards from the ground level or levels thereof to a height of 5.5 metres and (ii) pink hatched brown stippled orange on Plan Ia annexed hereto unless a clear space extending upwards from the ground level or levels thereof to a height of 3.0 metres are provided for public pedestrian passage purpose (which clear spaces in the said pink stippled orange area and the said pink hatched brown stippled orange area are hereinafter collectively referred to as "the Passage Area").
- (b) The Grantee shall on or before the 30th day of June 2027 or the expiry of 84 months from the Due Date or, if applicable, the Extended Due Date of Site F, whichever is the later or such other date or period as may be approved by the Director, at his own expense and in all respects to the satisfaction of the Director lay, form, provide, construct, surface and landscape the Passage Area in such manner with such materials and to such standards, levels, alignment and design as the Director shall approve including installation of street lights, planting of such shrubs and trees and provision and construction of such pavements or such other structures as the Director may require so that the Passage Area may be used for public pedestrian passage.
- (c) Upon completion of the works referred to in sub-clause (b) of this Special Condition, the Grantee shall throughout the term hereby agreed to be granted permit all members of the public at all times and for all lawful purposes freely and without payment of any nature whatsoever to pass and repass on foot or by wheelchair over the Passage Area.
- (d) Subject to sub-clause (b) of this Special Condition, the Grantee shall not carry out any work which may in the opinion of the Director (whose opinion shall be final and binding on the Grantee) affect the Passage Area.
- (e) The Passage Area shall not be used for any purpose other than for the passage of all members of the public on foot or by wheelchair.

- (f) The Grantee shall throughout the term hereby agreed to be granted at his own expense maintain the Passage Area in good and substantial repair and condition and keep the same clean and tidy in all respects to the satisfaction of the Director.
- (h) The Grantee shall throughout the term hereby agreed to be granted at all times permit the Government, its officers, agents, contractors, workmen or other duly authorized personnel with or without tools, equipment, plants, machinery or motor vehicles, the right of ingress, egress and regress to, from and through the lot or any part or parts thereof and any building or buildings erected or to be erected thereon for the purpose of inspecting, checking and supervising any works to be carried out by the Grantee under sub-clauses (b) and (f) of this Special Condition and the carrying out, inspecting, checking and supervising of the works under sub-clause (g) of this Special Condition.”

Relevant provisions of the deed of mutual covenant:

Definitions of “Estate Common Areas” and “Passage Area” in PDMC

“ “Estate Common Areas” means those parts of the Estate which are intended for use by Owners of more than one Phase and not for the sole benefit of any Owner, group of Owners or Owners of a particular Phase including, but not limited to, the Utility Trenches, the Future Footbridge Associated Structures (as defined in Special Condition No.(12)(b) of the Government Grant), the Passage Area, such part of the Pedestrian Link located outside the Land (which are included in this definition solely for management and maintenance purposes), part of the covered pedestrian walkway provided under Special Condition No.(59)(c) of the Government Grant (which solely for management and maintenance purposes, including those part of the covered pedestrian walkway located outside the Land), parapet walls, structural walls and columns, the foundations and other structural elements of the buildings erected on the Estate serving more than one Phase (but excluding those forming part of the Station or the Depot), common estate roads, and all other communal areas within the Estate not used for the sole benefit of any Owner, group of Owners or Owners of a particular Phase (but excluding those areas forming parts of the Residential Development Common Areas or the Common Areas of a particular Phase as designated or to be designated in the Sub-Deed of Mutual Covenant or Sub-Sub-Deed of Mutual Covenant or Deed Poll to be executed in connection with such Phase). The Estate Common Areas shall be more particularly identified on plans to be annexed to any Sub-Deed of Mutual Covenant or Sub-Sub-Deed of Mutual Covenant or Deed Poll to be executed in connection with any Phase.”

“ “Passage Area” means the Passage Area as defined in Special Condition No.(61)(a) of the Government Grant.”

Clause 4(d) of Part II of the Second Schedule to PDMC

“Subject to the terms of the Government Grant and the rights, easements and privileges of FSI as the Owner of the Government Accommodation under the Government Grant, this Deed and any Sub-Deed of Mutual Covenant or Sub-Sub-Deed of Mutual Covenant or Deed Poll, the rights for all members of the public

- (d) to pass and repass on foot or by wheelchair over the Passage Area at all times and for all lawful purposes freely and without payment of any nature whatsoever

PROVIDED THAT the exercise of such rights by the members of the public shall not in any way adversely affect or prejudice the rights, easements and privileges reserved to FSI as the Owner of the Government Accommodation under the Government Grant, this Deed and any Sub-Deed of Mutual Covenant or Sub-Sub-Deed of Mutual Covenant or Deed Poll.”

C. Open space that is required under the land grant to be managed, operated or maintained for public use at the expense of the owners of the residential properties in the Phase

Not applicable

D. Part of the land (on which the Phase is situated) that is dedicated to the public for the purposes of regulation 21 of the Building (Planning) Regulations (Cap. 113 sub.1 eg.F)

Not applicable

In relation to any of those facilities and open spaces, and those parts of the land, mentioned above, the general public has the right to use the facilities or open spaces, or the parts of the land, in accordance with the land grant or the deed of dedication (as the case may be).

In relation to any of those facilities and open spaces mentioned in Part B or C above, the facilities or open spaces are required to be managed, operated or maintained at the expense of the owners of the residential properties of the Phase, and those owners are required to meet a proportion of the expense of managing, operating or maintaining the facilities or open spaces through the management expenses apportioned to the residential properties concerned.

Notes:

1. In this Section, any reference to “Special Condition” shall be a reference to a Special Condition in the Land Grant, and “PDMC” and “SDMC” shall mean the Principal Deed of Mutual Covenant and Management Agreement of the Development and the Sub-Deed of Mutual Covenant and Management Agreement of the Phase respectively.
2. Pursuant to a letter dated 21 October 2020 issued by the Railway Development Section, Lands Department and registered in the Land Registry by Memorial No.20113001010307 (“the Letter”), the dates for completion of development, construction, formation or provision (as the case may be) of the following areas and facilities under the Land Grant will be amended as follows :-

Special Condition No.	Description	To be completed on or before
(12)(b)	Construction of Structural Supports and Connections to receive a Future Footbridge	23 March 2027
(13)(a)	Formation of the Green Area	10 June 2027
(17)(a)	Formation of the Stippled Green Area	23 March 2027
(29)(a)	Provision of Government Accommodation	11 December 2024
(43)(a)	Provision of Public Open Space	23 March 2027
(59)(c)	Provision of Pedestrian Walkway	23 March 2027

17 公共設施及公眾休憩用地的資料 INFORMATION ON PUBLIC FACILITIES AND PUBLIC OPEN SPACES

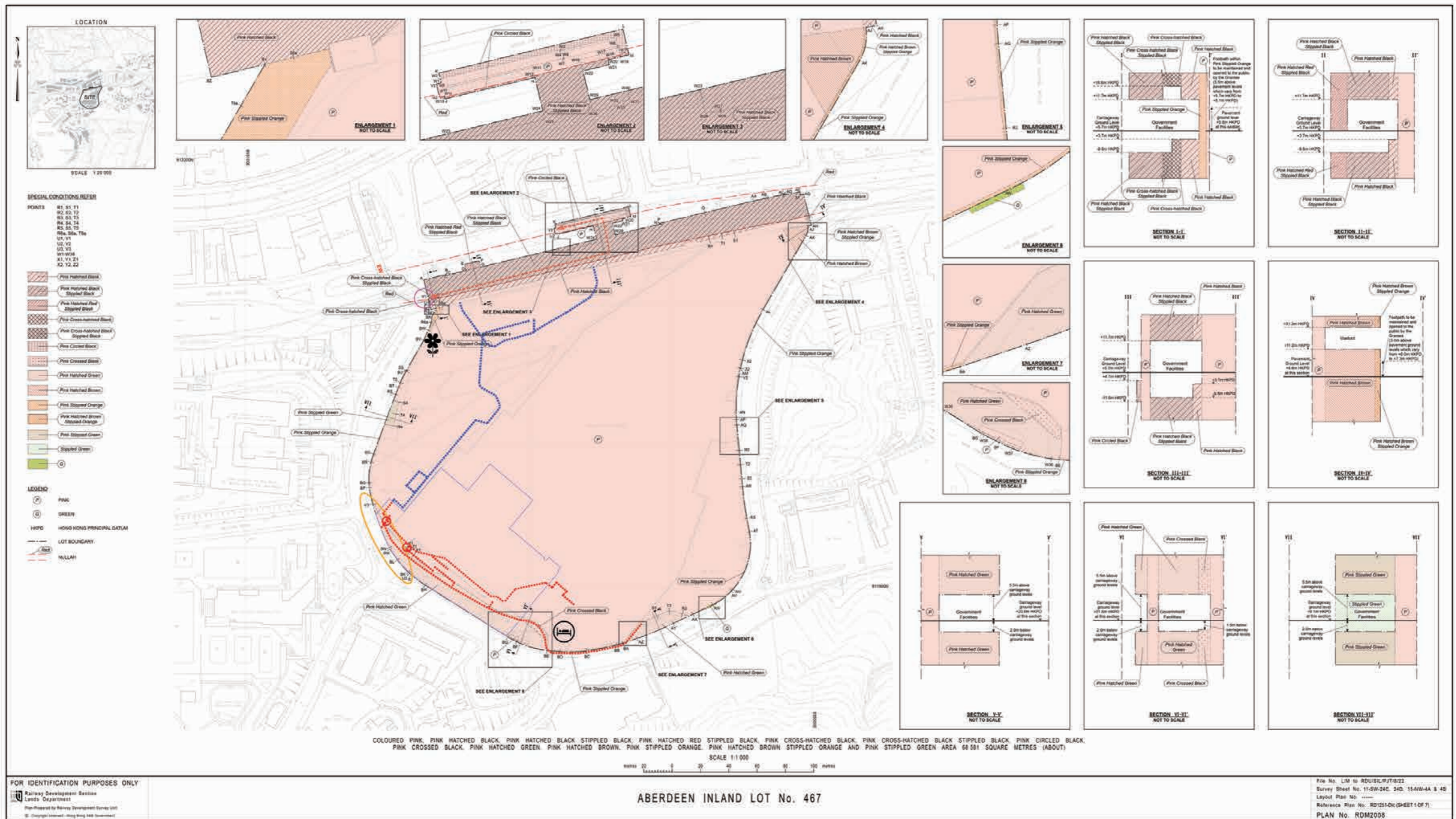







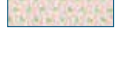



備註：
此圖複製附於批地文件的圖則 Ia，有需要處經修正處理，以顯示相關公共設施的位置。

Remark:
This plan is a reproduction of Plan Ia as annexed to the Land Grant, with adjustments where necessary, which shows the location of the relevant public facilities.

圖例 Legend

	粉紅色加黑斜線 Pink hatched black
	粉紅色加黑斜線黑點 Pink hatched black stippled black
	粉紅色加紅斜線黑點 Pink hatched red stippled black
	粉紅色加黑交叉斜線 Pink cross-hatched black
	粉紅色加黑交叉斜線黑點 Pink cross-hatched black stippled black
	粉紅色加黑圓圈 Pink circled black
	粉紅色加黑交叉 Pink crossed black
	粉紅色加綠斜線 Pink hatched green
	粉紅色加棕斜線 Pink hatched brown
	粉紅色加橙點 Pink stippled orange
	粉紅色加棕斜線橙點 Pink hatched brown stippled orange
	粉紅色加綠點 Pink stippled green
	綠色圓點 Stippled green
	綠色範圍 Green area

	政府樓宇（綜合職業復康服務中心及中度弱智人士宿舍） Government Accommodation (Integrated vocational rehabilitation services centre and hostel for moderately mentally handicapped persons)
	擬建之公眾休憩用地，總面積不少於1,300平方米 Proposed Public Open Space with a total area of not less than 1,300 square metres
	B地盤界線 Boundary of Site B
	已建之行人通道 As-Built Pedestrian Walkway
	擬建之行人通道 Proposed Pedestrian Walkway
	公眾行人通道（於黃竹坑站營運時間內開放） Public Pedestrian Access during the operation hours of the Wong Chuk Hang Station
	現有行人天橋 Existing Footbridge
	行人天橋相關結構 Footbridge Associated Structures
	擬建於U3及V3之間的行人天橋 Future footbridge which may be located at a position between the points U3 and V3
	未來行人天橋相關結構 Future Footbridge Associated Structures

PLAN 1 圖一

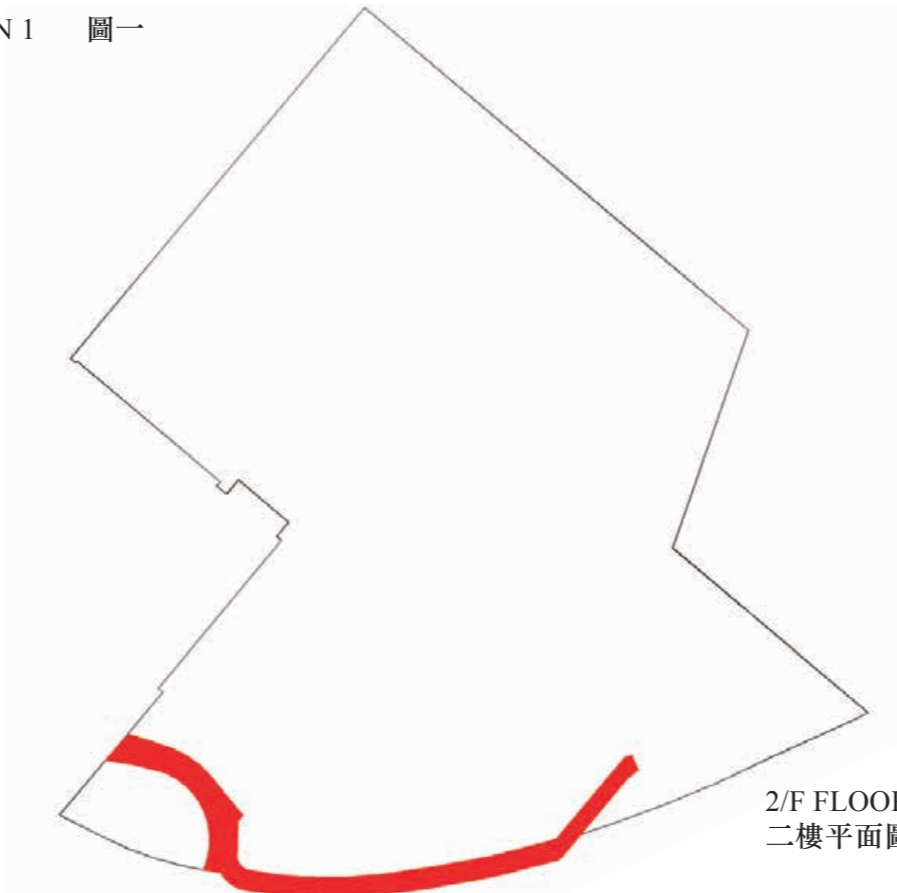

2/F FLOOR PLAN
 二樓平面圖

PLAN 2 圖二

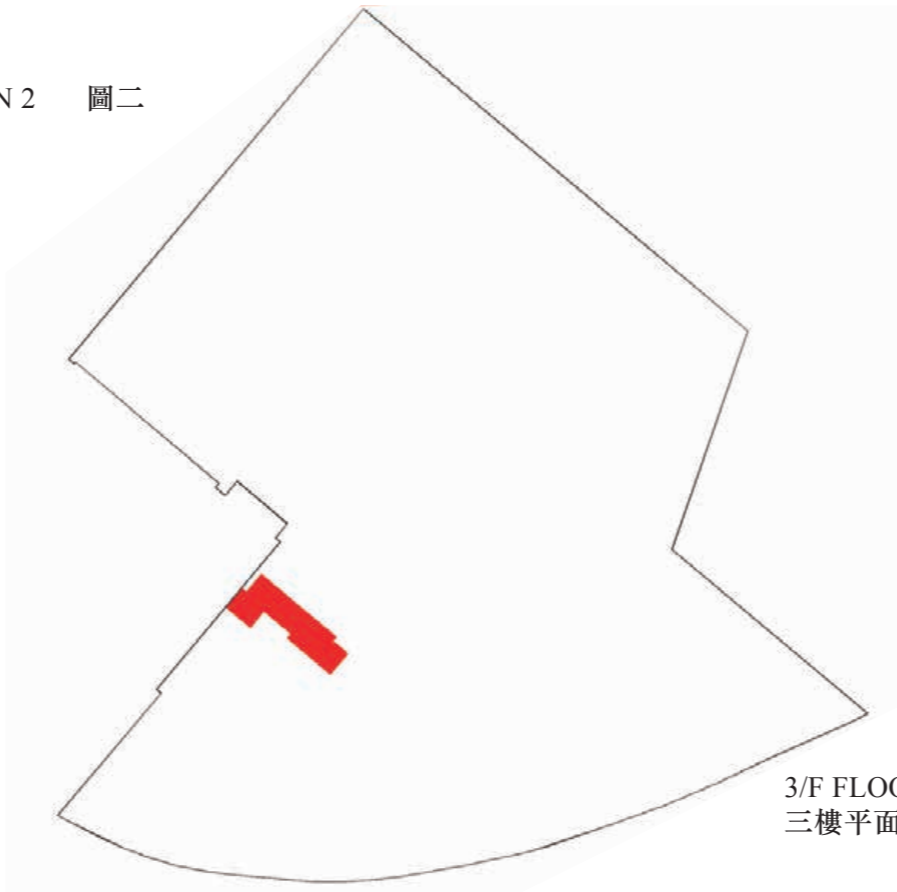

3/F FLOOR PLAN
 三樓平面圖



KEY PLAN 索引圖



KEY PLAN 索引圖

Remark :

The plan is for showing the location of the as-built Pedestrian Walkway only. Other matters shown in the plan may not reflect their latest condition.

備註：

本圖僅作顯示已建之行人通道的位置。本圖中所示之其他事項未必反映其最新狀況。

LEGEND 圖例

 As-Built Pedestrian Walkway
 已建之行人通道

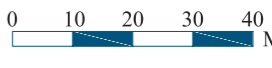
比例： 0 10 20 30 40
 Scale:  METERS 米

PLAN 3 圖三

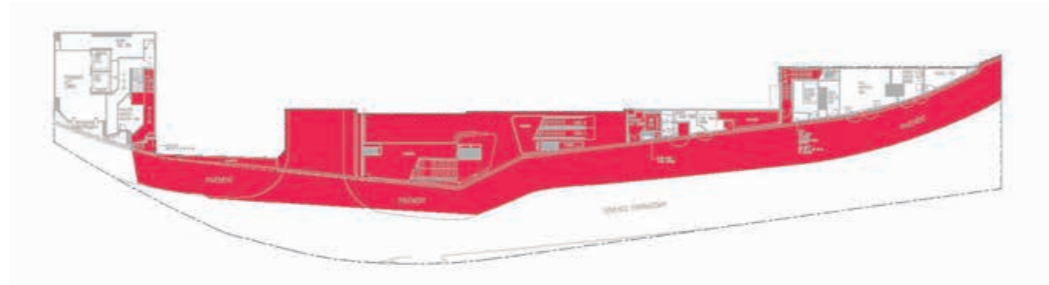

2/F FLOOR PLAN
 二樓平面圖



KEY PLAN 索引圖

PLAN 4 圖四



3/F FLOOR PLAN
 三樓平面圖

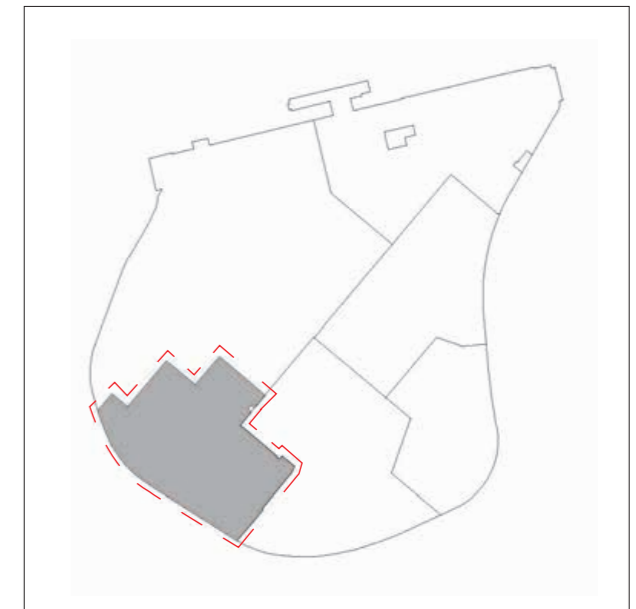

KEY PLAN 索引圖

Remark :

The plan is for showing the location of the as-built Pedestrian Walkway only. Other matters shown in the plan may not reflect their latest condition.

備註：

本圖僅作顯示已建之行人通道的位置。本圖中所示之其他事項未必反映其最新狀況。

LEGEND 圖例

 As-Built Pedestrian Walkway
 已建之行人通道

比例: 0 10 20 30 40 METERS 米
 Scale:

PLAN 5 圖五

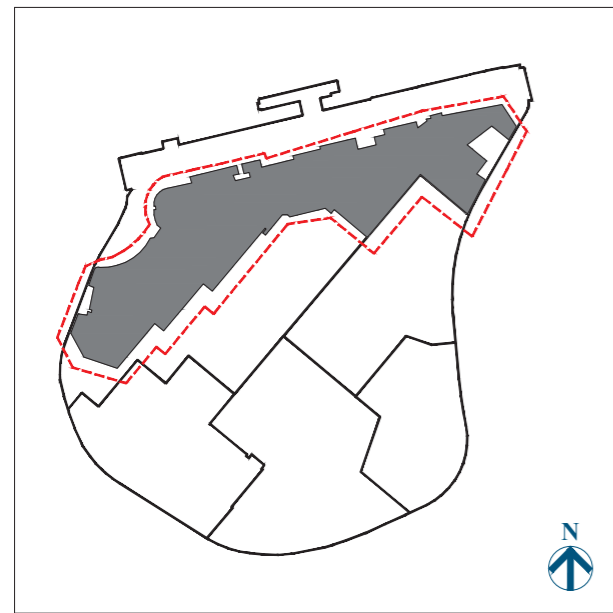

KEY PLAN 索引圖

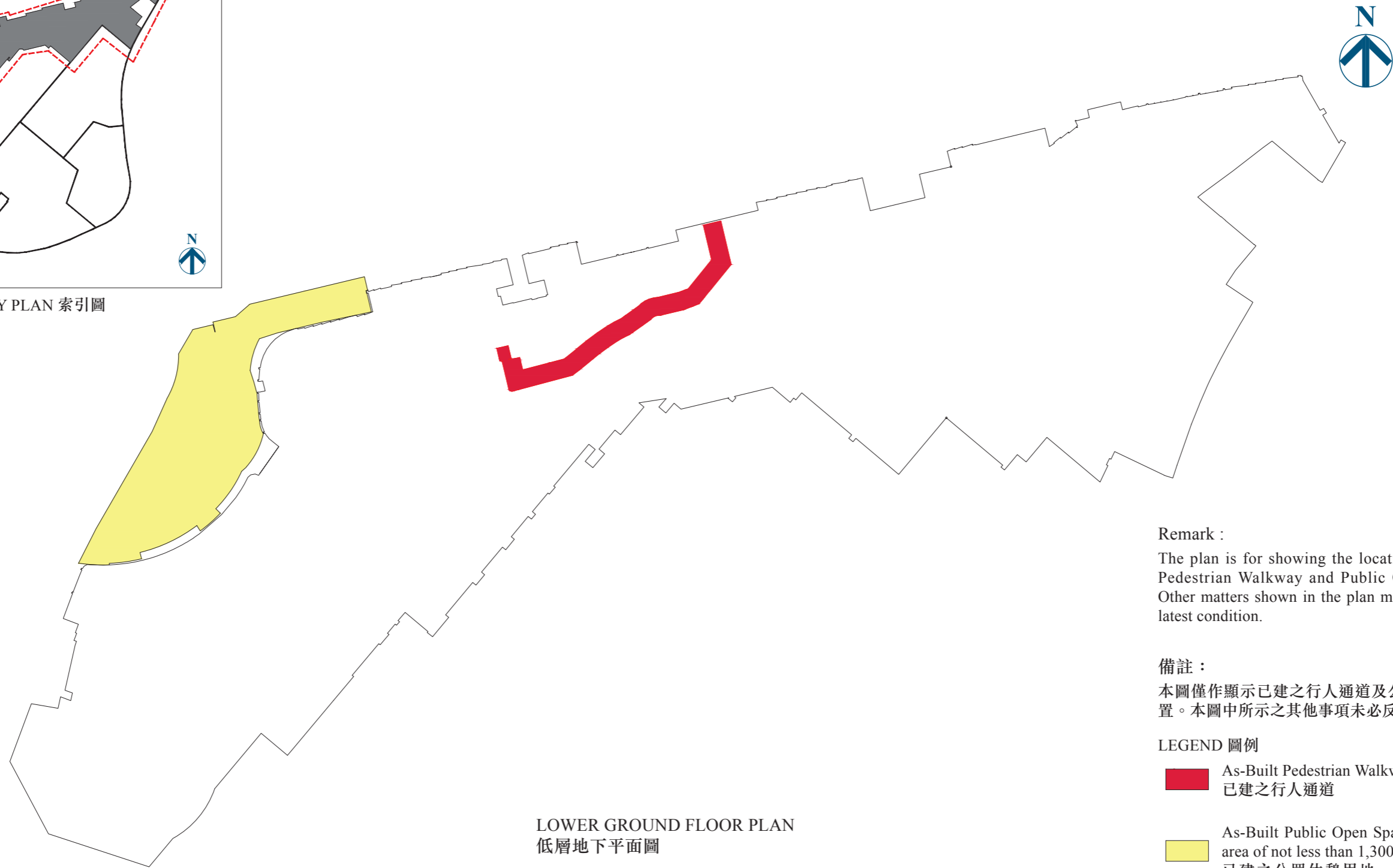

LOWER GROUND FLOOR PLAN
 低層地下平面圖

Remark :

The plan is for showing the location of the as-built Pedestrian Walkway and Public Open Space only. Other matters shown in the plan may not reflect their latest condition.

備註：

本圖僅作顯示已建之行人通道及公眾休憩用地的位置。本圖中所示之其他事項未必反映其最新狀況。

LEGEND 圖例

 As-Built Pedestrian Walkway
 已建之行人通道

 As-Built Public Open Space with a total area of not less than 1,300 square metres
 已建之公眾休憩用地，總面積不少於1,300平方米

比例: 0 10 20 30 40 50
 Scale:  METERS 米

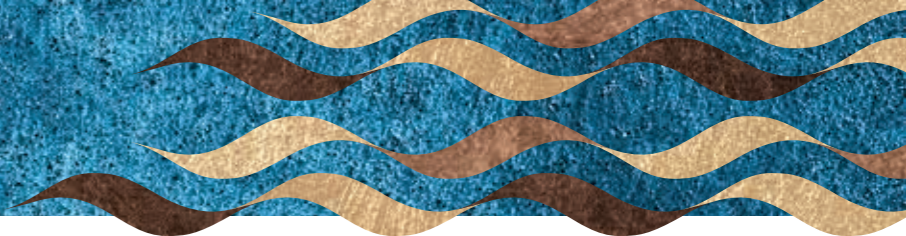

PLAN 6 圖六

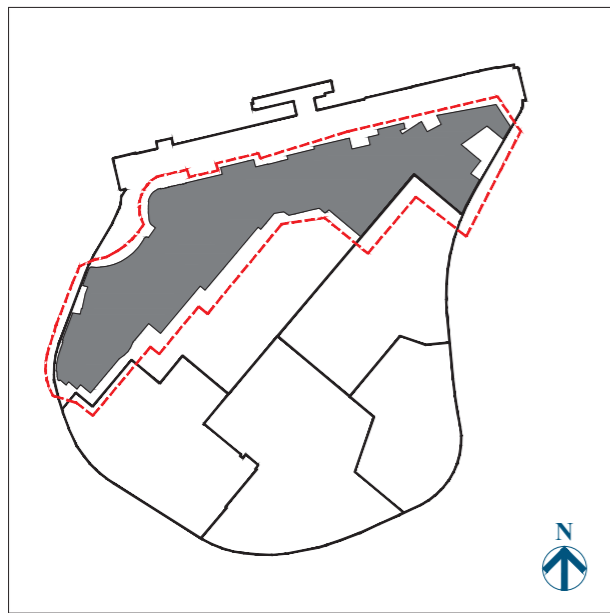

KEY PLAN 索引圖

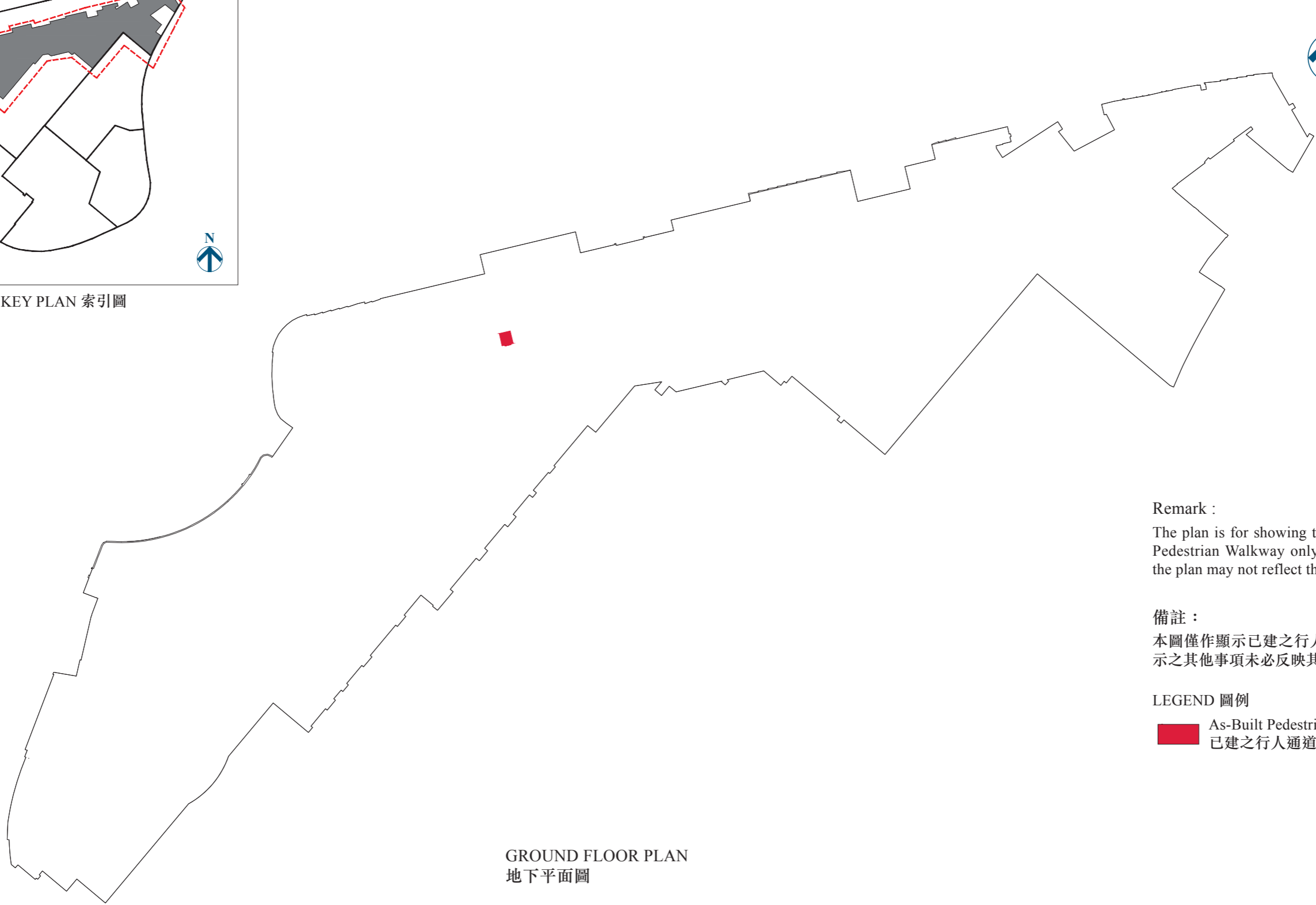

GROUND FLOOR PLAN
 地下平面圖

Remark :
 The plan is for showing the location of the as-built Pedestrian Walkway only. Other matters shown in the plan may not reflect their latest condition.

備註：
 本圖僅作顯示已建之行人通道的位置。本圖中所示之其他事項未必反映其最新狀況。

LEGEND 圖例
 As-Built Pedestrian Walkway
 已建之行人通道

比例: 0 10 20 30 40 50 METERS 米
 Scale:  METERS 米

PLAN 7 圖七

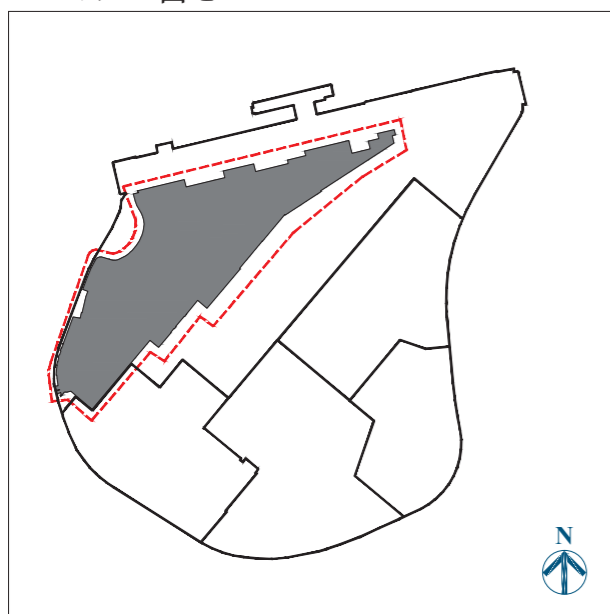

KEY PLAN 索引圖

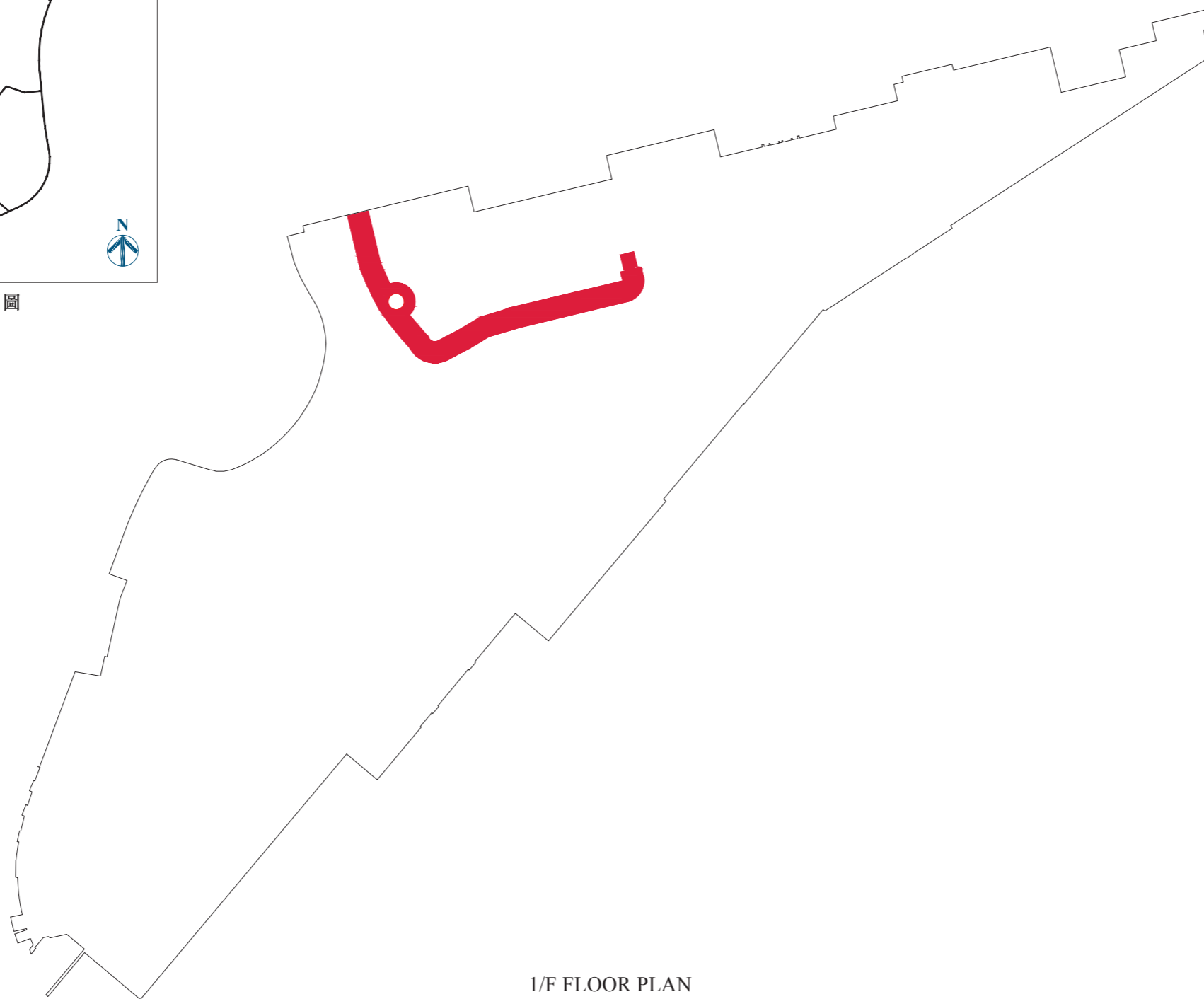

1/F FLOOR PLAN
 一樓平面圖



Remark :

The plan is for showing the location of the as-built Pedestrian Walkway only. Other matters shown in the plan may not reflect their latest condition.

備註：

本圖僅作顯示已建之行人通道的位置。本圖中所示之其他事項未必反映其最新狀況。

LEGEND 圖例

- As-Built Pedestrian Walkway
 已建之行人通道

比例: 0 10 20 30 40 50 METERS 米
 Scale: METERS 米

PLAN 8 圖八

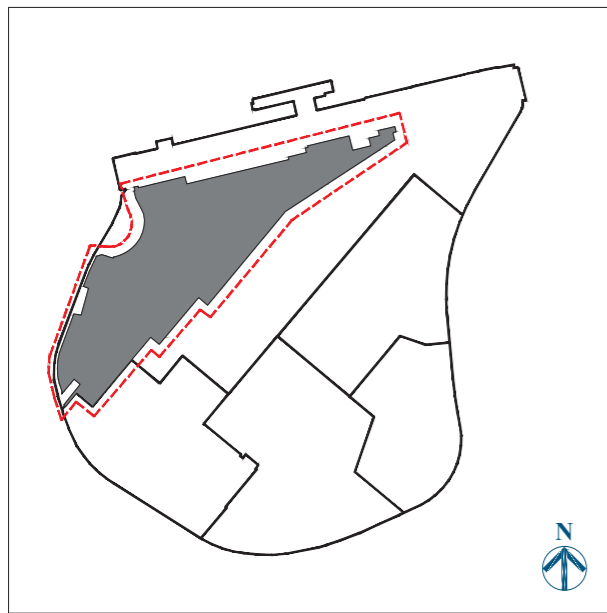

KEY PLAN 索引圖

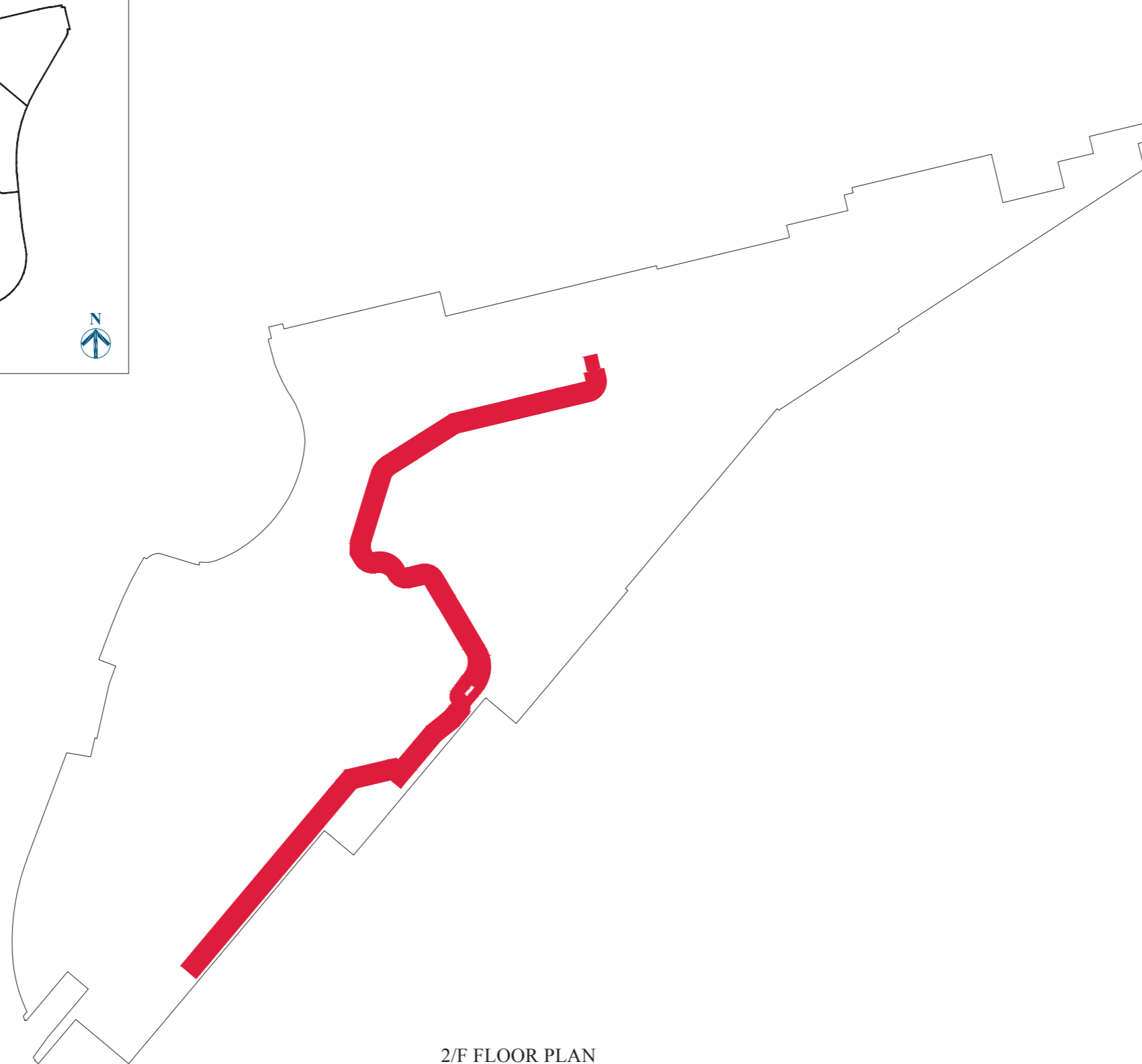

2/F FLOOR PLAN
 二樓平面圖



Remark :

The plan is for showing the location of the as-built Pedestrian Walkway only. Other matters shown in the plan may not reflect their latest condition.

備註：

本圖僅作顯示已建之行人通道的位置。本圖中所示之其他事項未必反映其最新狀況。

LEGEND 圖例

- As-Built Pedestrian Walkway
 已建之行人通道

比例: 0 10 20 30 40 50
 Scale: METERS 米

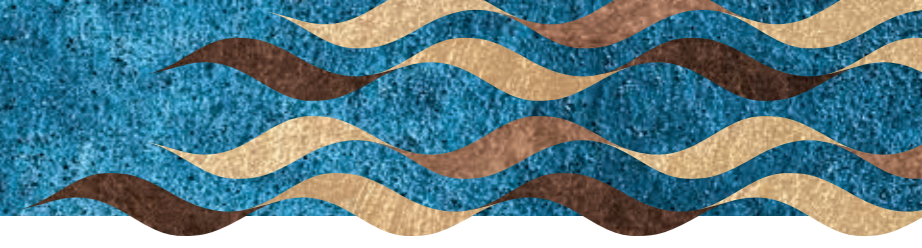

PLAN 9 圖九

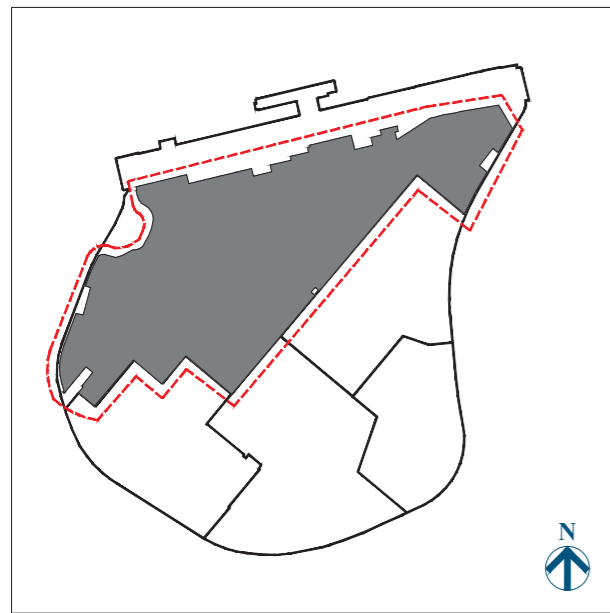

KEY PLAN 索引圖

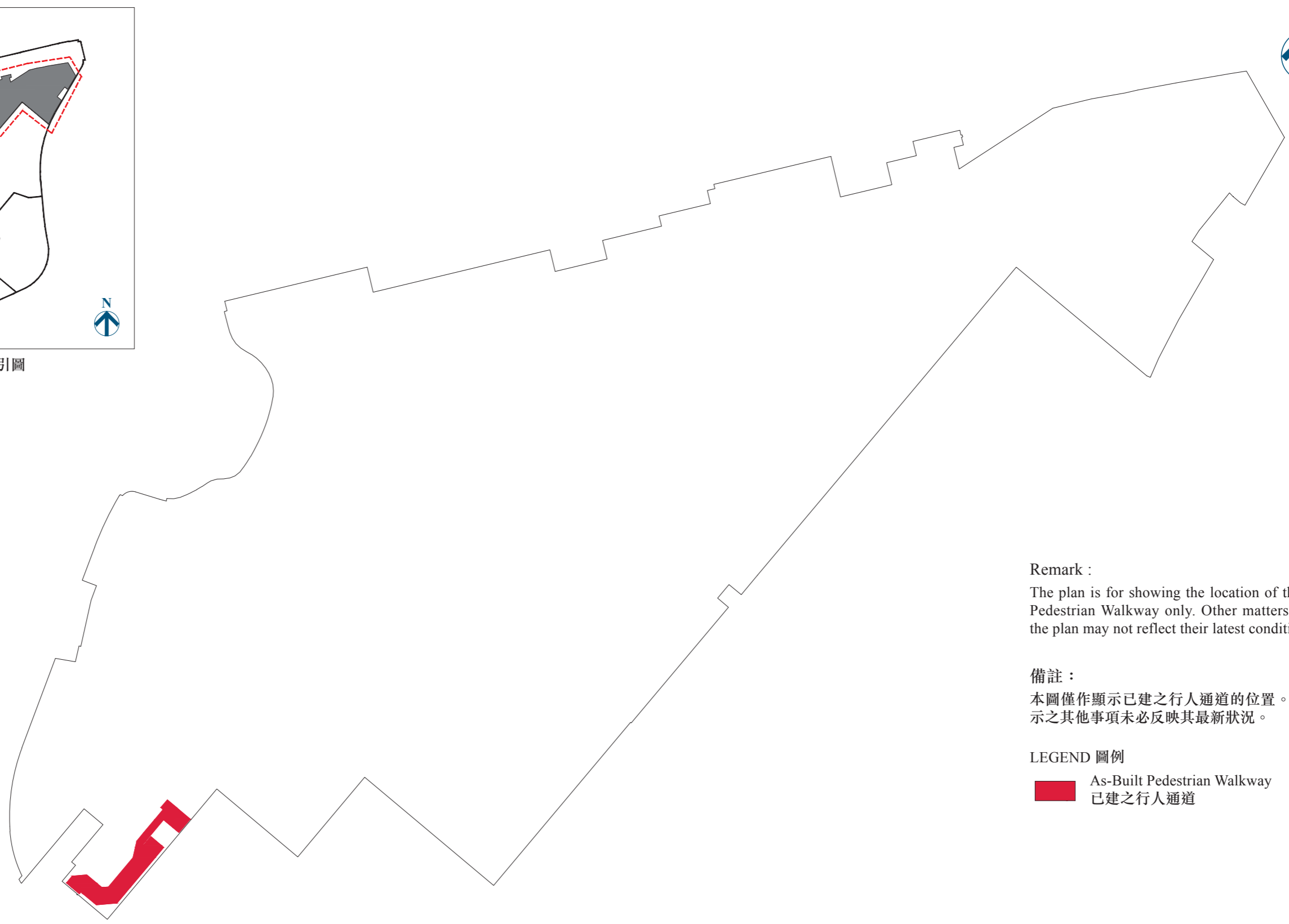

3/F FLOOR PLAN
 三樓平面圖



Remark :
 The plan is for showing the location of the as-built Pedestrian Walkway only. Other matters shown in the plan may not reflect their latest condition.

備註：
 本圖僅作顯示已建之行人通道的位置。本圖中所示之其他事項未必反映其最新狀況。

LEGEND 圖例
 As-Built Pedestrian Walkway
 已建之行人通道

比例: 0 10 20 30 40 50
 Scale:  METERS 米

This page is intentionally left blank.
此頁乃特意留白。

1. 謹此建議買方聘用一間獨立的律師事務所（代表擁有人行事者除外），以在交易中代表買方行事。
 2. 如買方聘用上述的獨立的律師事務所，以在交易中代表買方行事，該律師事務所將會能夠向買方提供獨立意見。
 3. 如買方聘用代表擁有人行事的律師事務所同時代表買方行事，而擁有人與買方之間出現利益衝突：
 - (a) 該律師事務所可能不能夠保障買方的利益；及
 - (b) 買方可能要聘用一間獨立的律師事務所。
 4. 如屬上述3(b)段的情況，買方須支付的律師費用總數，可能高於如買方自一開始即聘用一間獨立的律師事務所便須支付的費用。
1. The purchaser is hereby recommended to instruct a separate firm of solicitors (other than that acting for the owner) to act for the purchaser in relation to the transaction.
 2. If the purchaser instructs such separate firm of solicitors to act for the purchaser in relation to the transaction, that firm will be able to give independent advice to the purchaser.
 3. If the purchaser instructs the firm of solicitors acting for the owner to act for the purchaser as well, and a conflict of interest arises between the owner and the purchaser:
 - (a) that firm may not be able to protect the purchaser's interests; and
 - (b) the purchaser may have to instruct a separate firm of solicitors.
 4. In the case of paragraph 3(b) above, the total solicitors' fees payable by the purchaser may be higher than the fees that would have been payable if the purchaser had instructed a separate firm of solicitors in the first place.

第1座 (A 及 B) Tower 1 (A and B)

TOP ROOF	頂層天台
UPPER ROOF	上層天台
ROOF	天台

32/F RESIDENTIAL UNITS	32樓住宅單位
31/F RESIDENTIAL UNITS	31樓住宅單位
30/F RESIDENTIAL UNITS	30樓住宅單位
29/F RESIDENTIAL UNITS	29樓住宅單位
28/F RESIDENTIAL UNITS	28樓住宅單位
27/F RESIDENTIAL UNITS	27樓住宅單位
26/F RESIDENTIAL UNITS	26樓住宅單位
25/F RESIDENTIAL UNITS	25樓住宅單位
23/F RESIDENTIAL UNITS	23樓住宅單位
22/F RESIDENTIAL UNITS	22樓住宅單位
21/F RESIDENTIAL UNITS	21樓住宅單位
20/F RESIDENTIAL UNITS	20樓住宅單位
19/F RESIDENTIAL UNITS	19樓住宅單位
18/F RESIDENTIAL UNITS	18樓住宅單位
17/F RESIDENTIAL UNITS	17樓住宅單位
16/F RESIDENTIAL UNITS	16樓住宅單位
15/F RESIDENTIAL UNITS	15樓住宅單位
12/F RESIDENTIAL UNITS	12樓住宅單位
11/F RESIDENTIAL UNITS	11樓住宅單位
10/F RESIDENTIAL UNITS	10樓住宅單位
9/F REFUGE FLOOR	9樓庇護層
8/F RESIDENTIAL UNITS	8樓住宅單位
7/F RESIDENTIAL UNITS	7樓住宅單位
6/F RESIDENTIAL UNITS	6樓住宅單位
5/F RESIDENTIAL UNITS	5樓住宅單位

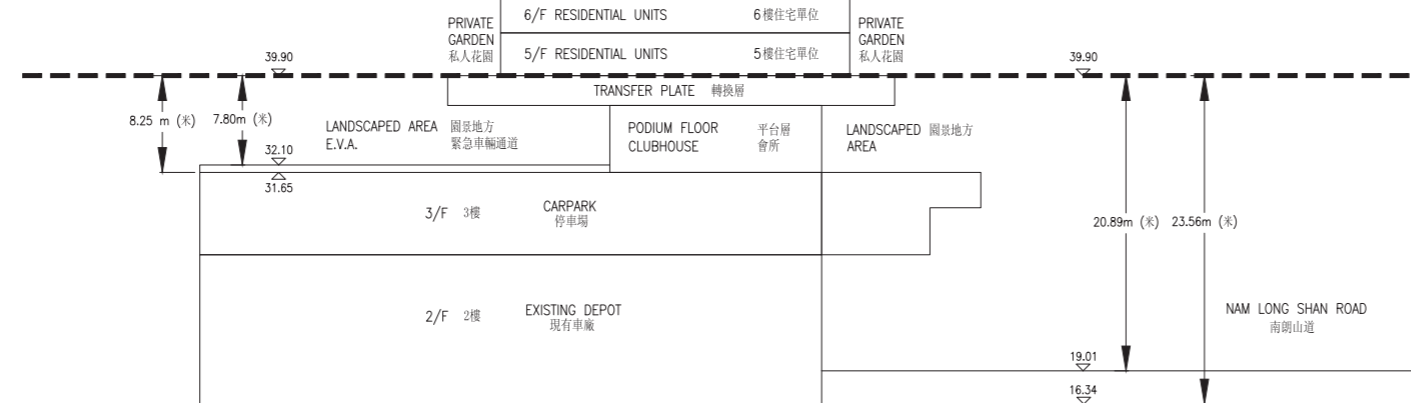

橫截面圖 A
Cross-section plan A

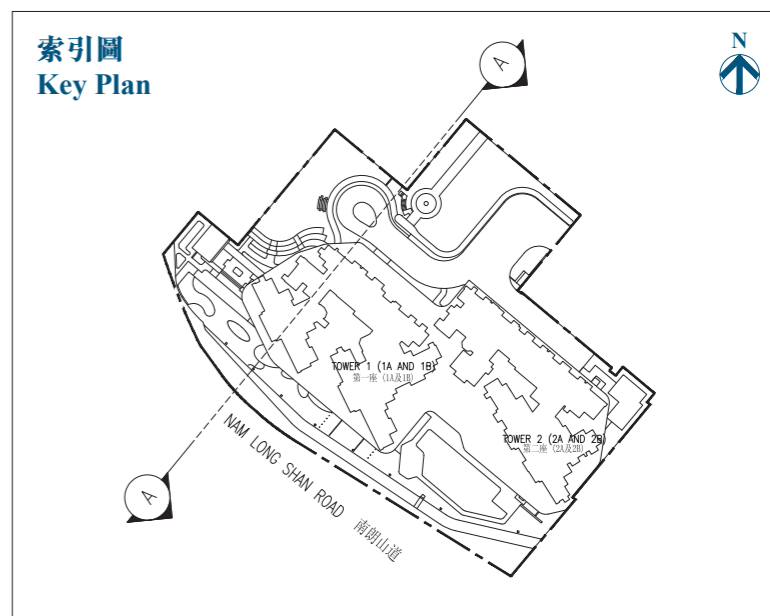

備註：

1. (---) 虛線為該建築物最低住宅樓層水平。
2. (▽)及(△)指香港主水平基準以上高度(米)。
3. 毗連建築物的一段緊急車輛通道為香港主水平基準以上31.65米至32.10米。
4. 毗連建築物的一段南朗山道為香港主水平基準以上16.34米至19.01米。
5. 不設4樓、13樓、14樓及24樓。

Notes:

1. (---) Dotted line denotes the level of the lowest residential floor of the Building.
2. (▽) and (△) denote height (in meters) above the Hong Kong Principal Datum (HKPD).
3. The part of Emergency Vehicular Access (E.V.A.) adjacent to the building is 31.65 metres to 32.10 metres above the Hong Kong Principal Datum.
4. The part of Nam Long Shan Road adjacent to the building is 16.34 metres to 19.01 metres above the Hong Kong Principal Datum.
5. 4/F, 13/F, 14/F and 24/F are omitted.

第2座 (A 及 B) Tower 2 (A and B)

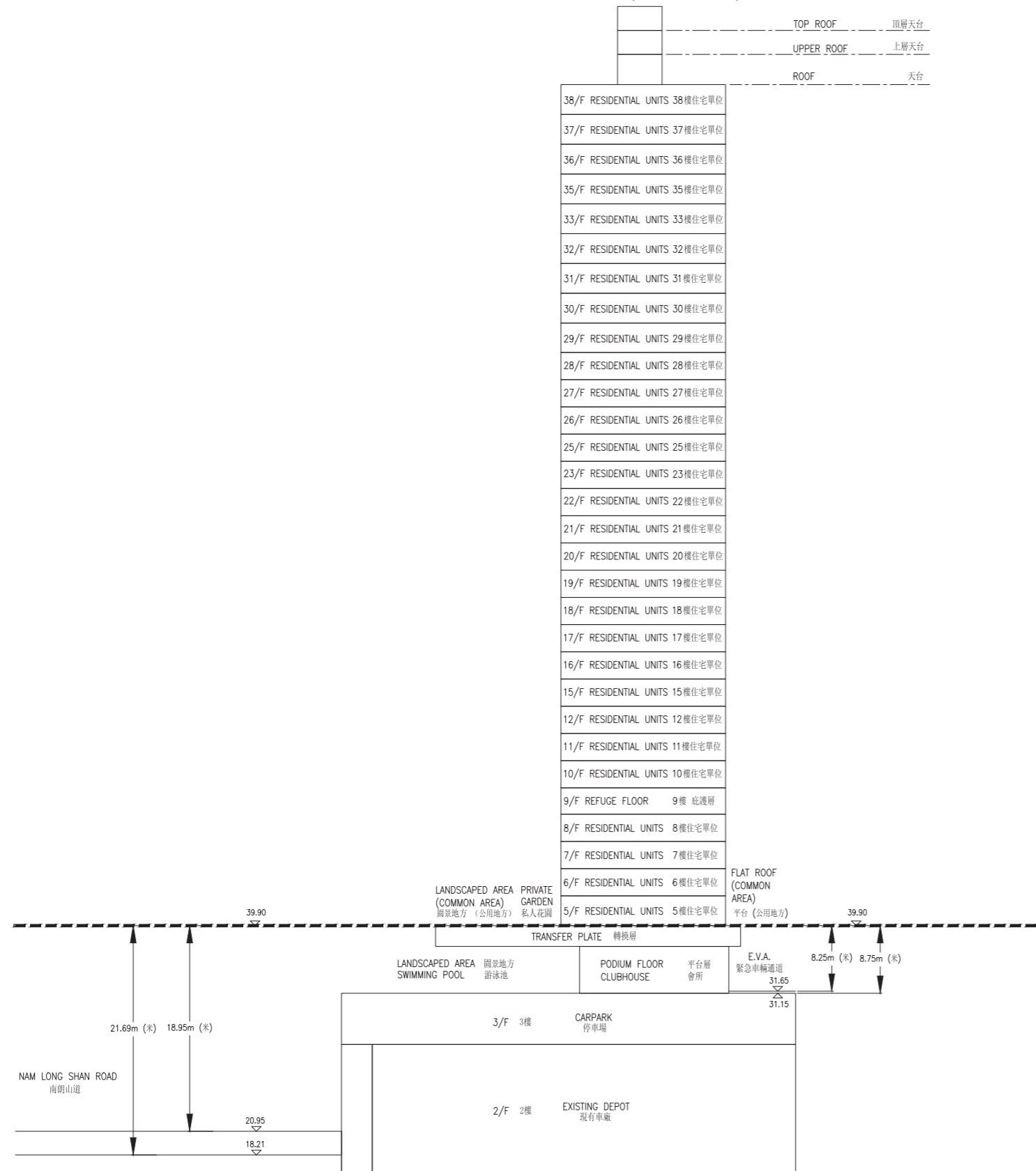

橫截面圖 B
Cross-section plan B

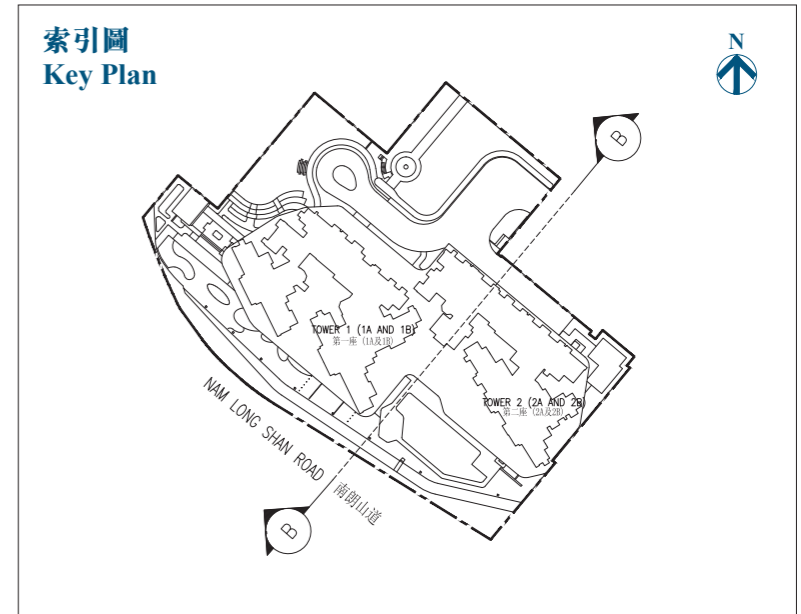

備註：

1. (-----) 虛線為該建築物最低住宅樓層水平。
2. (▽)及(△)指香港主水平基準以上高度(米)。
3. 毗連建築物的一段緊急車輛通道為香港主水平基準以上31.15米至31.65米。
4. 毗連建築物的一段南朗山道為香港主水平基準以上18.21米至20.95米。
5. 不設4樓、13樓、14樓、24樓及34樓。

Notes:

1. (-----) Dotted line denotes the level of the lowest residential floor of the Building.
2. (▽) and (△) denote height (in meters) above the Hong Kong Principal Datum (HKPD).
3. The part of Emergency Vehicular Access (E.V.A.) adjacent to the building is 31.15 metres to 31.65 metres above the Hong Kong Principal Datum.
4. The part of Nam Long Shan Road adjacent to the building is 18.21 metres to 20.95 metres above the Hong Kong Principal Datum.
5. 4/F, 13/F, 14/F, 24/F and 34/F are omitted.

第1座 (A 及 B)
Tower 1 (A and B)

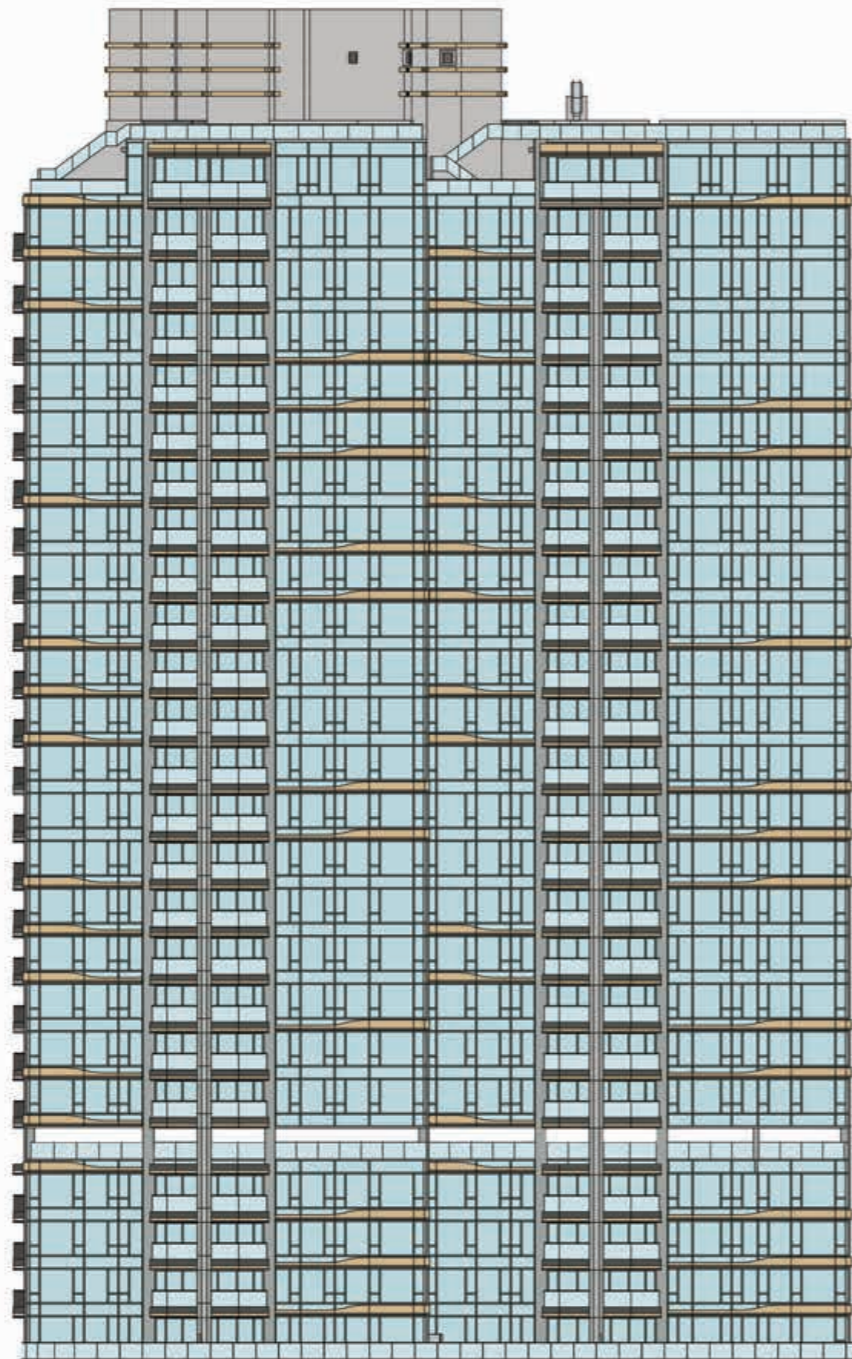

立面圖 1
Elevation plan 1

第1座 (A 及 B)
Tower 1 (A and B)

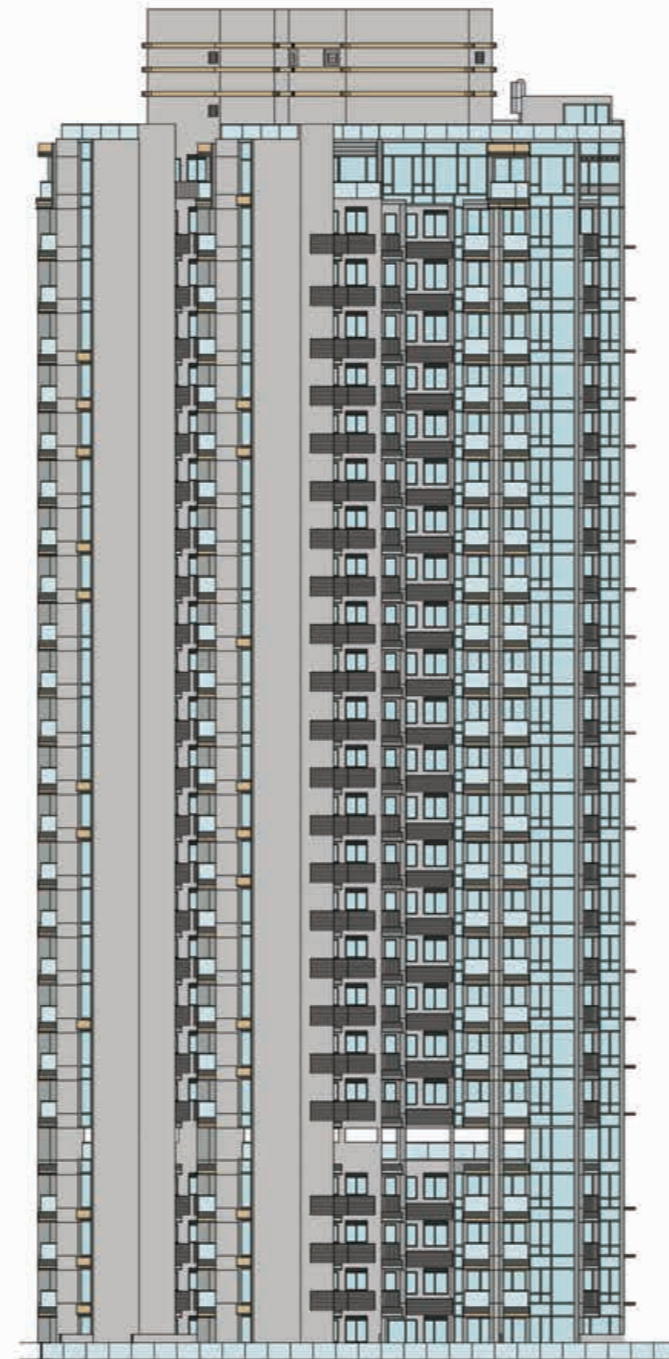

立面圖 2
Elevation plan 2

索引圖
Key Plan



期數的認可人士證明本圖所顯示的立面：

- (1) 以2022年7月7日的期數經批准的建築圖則為基礎擬備；及
- (2) 大致上與期數的外觀一致。

Authorized Person for the Phase has certified that the elevations shown on this plan:

- (1) are prepared on the basis of the approved building plans for the Phase as at 7 July 2022; and
- (2) are in general accordance with the outward appearance of the Phase.

第1座 (A 及 B)
Tower 1 (A and B)

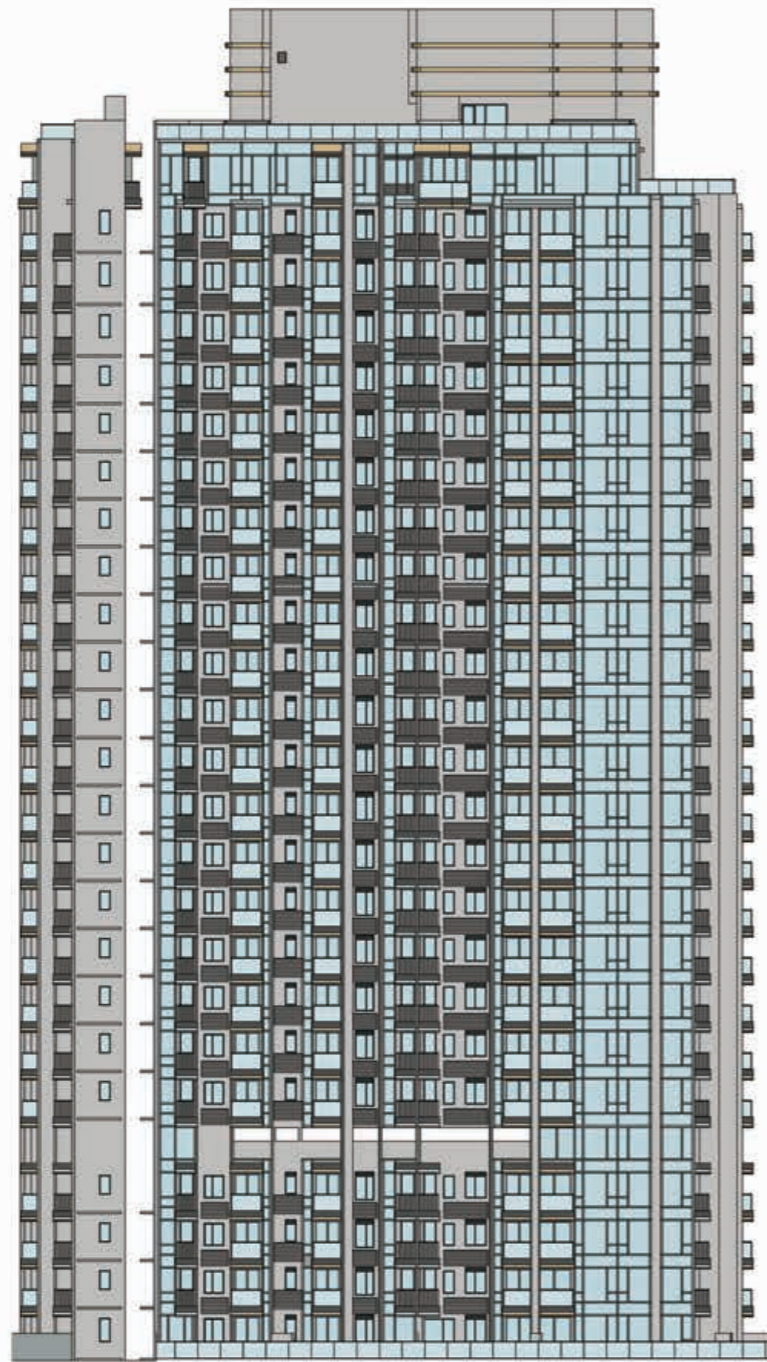

立面圖 3
Elevation plan 3

第1座 (A 及 B)
Tower 1 (A and B)



立面圖 4
Elevation plan 4

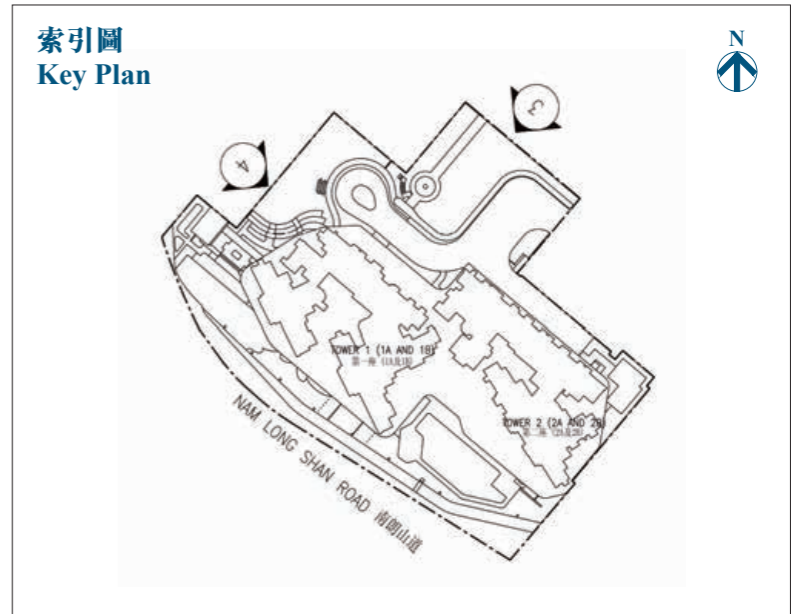

期數的認可人士證明本圖所顯示的立面：

- (1) 以2022年7月7日的期數經批准的建築圖則為基礎擬備；及
- (2) 大致上與期數的外觀一致。

Authorized Person for the Phase has certified that the elevations shown on this plan:

- (1) are prepared on the basis of the approved building plans for the Phase as at 7 July 2022; and
- (2) are in general accordance with the outward appearance of the Phase.

第2座 (A 及 B)
Tower 2 (A and B)

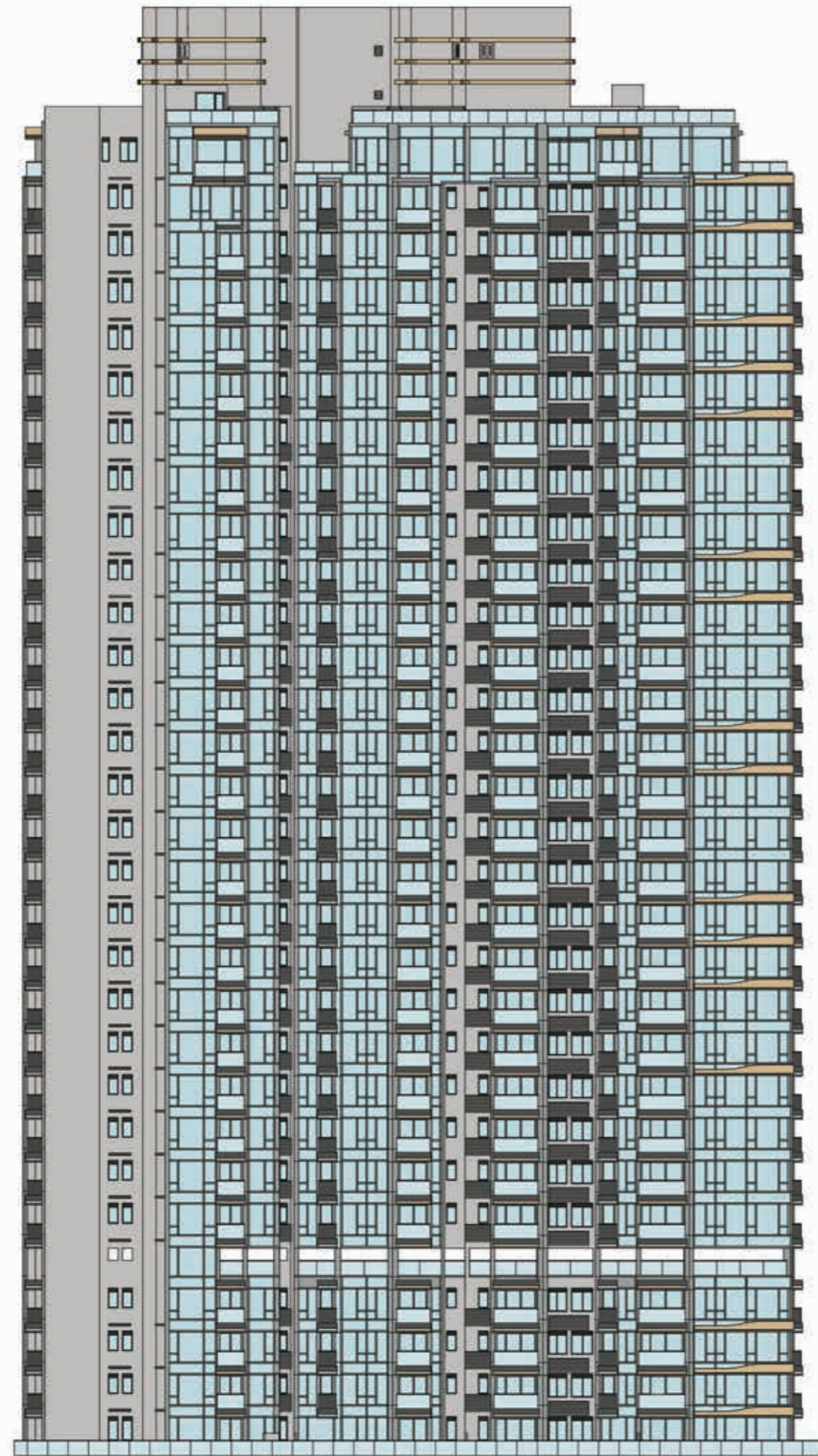

立面圖 5
Elevation plan 5

第2座 (A 及 B)
Tower 2 (A and B)



立面圖 6
Elevation plan 6

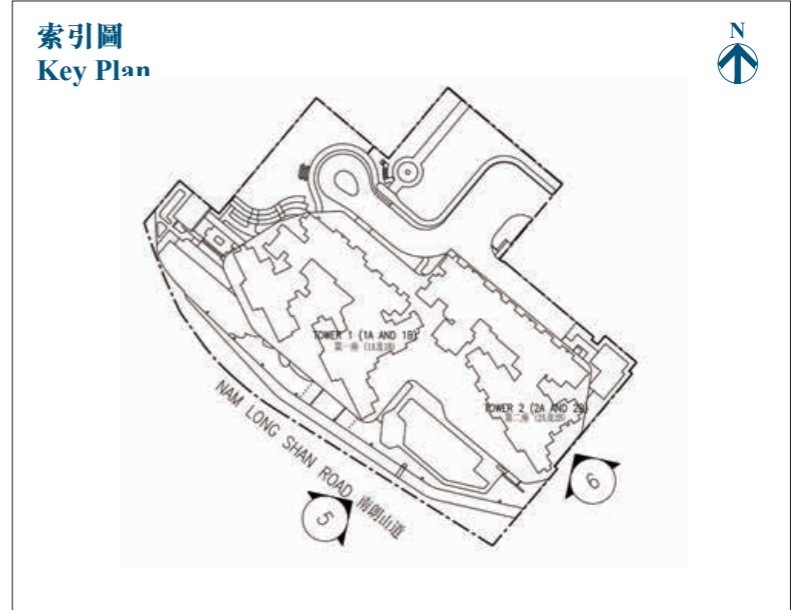

期數的認可人士證明本圖所顯示的立面：

- (1) 以2022年7月7日的期數經批准的建築圖則為基礎擬備；及
- (2) 大致上與期數的外觀一致。

Authorized Person for the Phase has certified that the elevations shown on this plan:

- (1) are prepared on the basis of the approved building plans for the Phase as at 7 July 2022; and
- (2) are in general accordance with the outward appearance of the Phase.

第2座 (A 及 B)
Tower 2 (A and B)

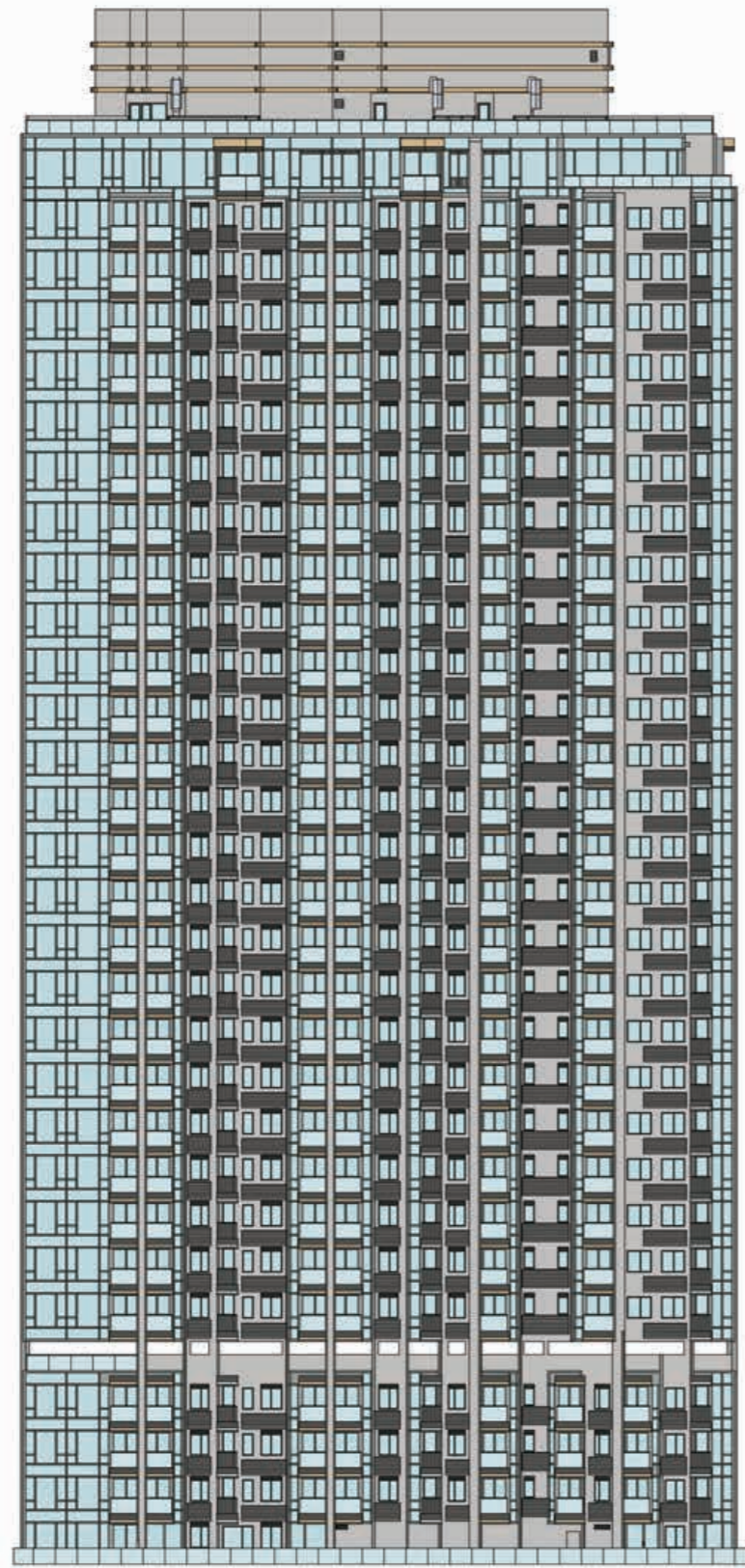

立面圖 7
Elevation plan 7

第2座 (A 及 B)
Tower 2 (A and B)



立面圖 8
Elevation plan 8

索引圖
Key Plan

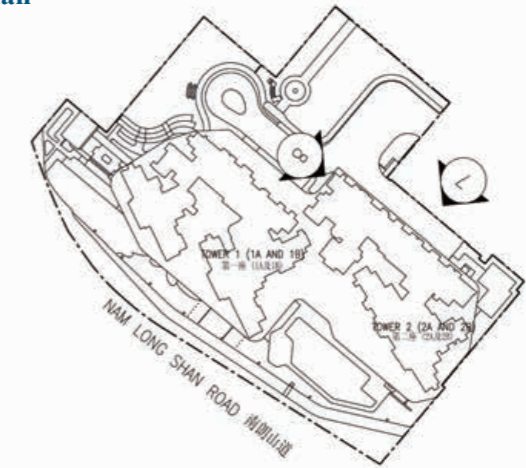

期數的認可人士證明本圖所顯示的立面：

- (1) 以2022年7月7日的期數經批准的建築圖則為基礎擬備；及
- (2) 大致上與期數的外觀一致。

Authorized Person for the Phase has certified that the elevations shown on this plan:

- (1) are prepared on the basis of the approved building plans for the Phase as at 7 July 2022; and
- (2) are in general accordance with the outward appearance of the Phase.

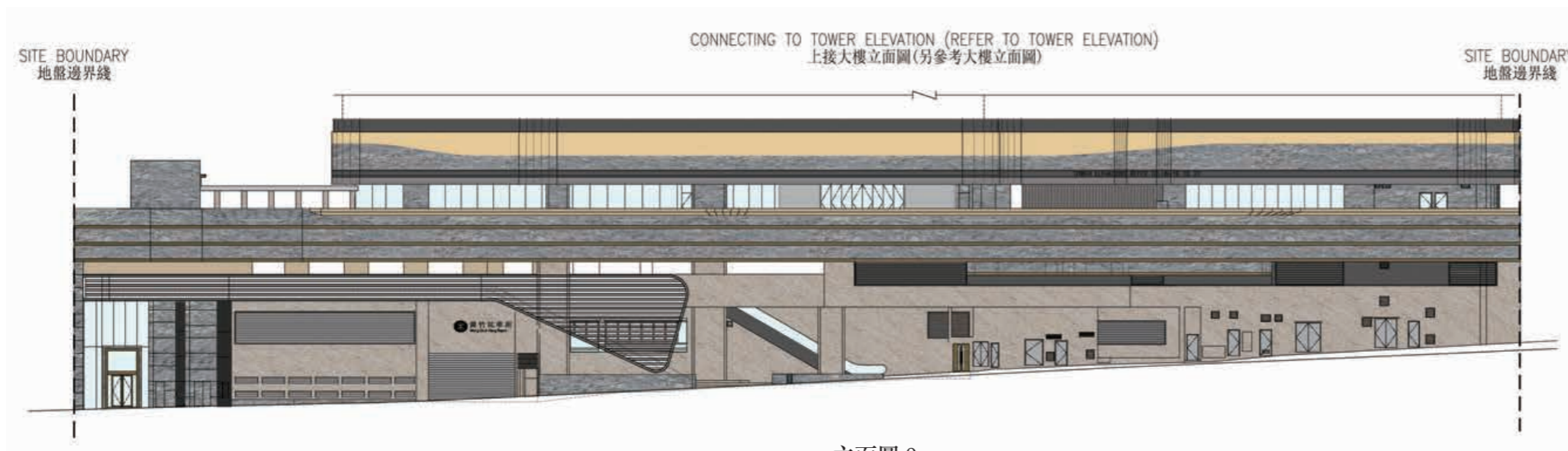
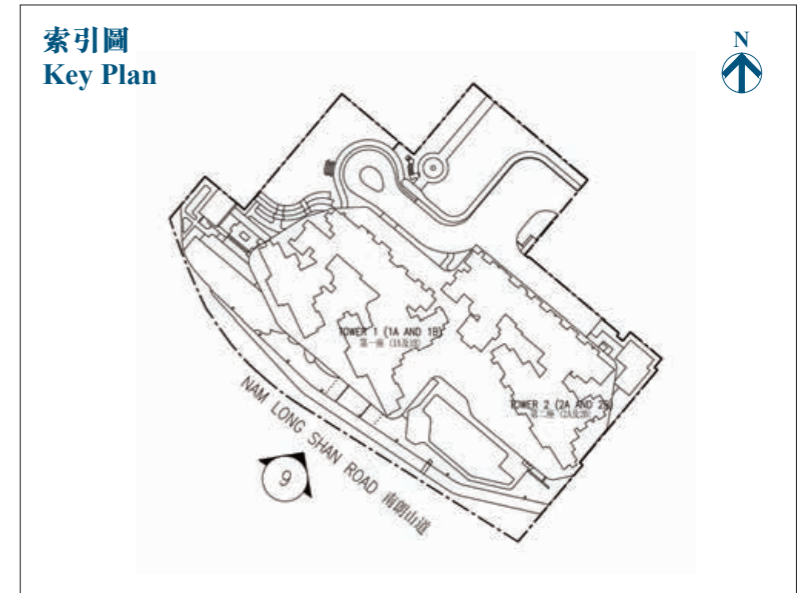

立面圖 9
Elevation plan 9

期數的認可人士證明本圖所顯示的立面：

- (1) 以2022年7月7日的期數經批准的建築圖則為基礎擬備；及
- (2) 大致上與期數的外觀一致。

Authorized Person for the Phase has certified that the elevations shown on this plan:

- (1) are prepared on the basis of the approved building plans for the Phase as at 7 July 2022; and
- (2) are in general accordance with the outward appearance of the Phase.

21 期數中的公用設施的資料 INFORMATION ON COMMON FACILITIES IN THE PHASE

公用設施 Common Facilities		有上蓋面積 Covered Area	無上蓋面積 Uncovered Area	總面積 Total Area
住客會所（包括供住客使用的任何康樂設施） Residents' clubhouse (including any recreational facilities for residents' use)	平方呎 sq.ft	12,287	5,070	17,357
	平方米 sq.m	1,141.509	470.981	1,612.490
位於期數中的建築物的天台或在天台和最低一層住宅樓層之間的任何一層的、供住客使用的公用花園或遊樂地方（不論是稱為公用空中花園或有其他名稱） Communal garden or play area for residents' use on the roof, or on any floor between the roof and the lowest residential floor, of a building in the Phase (whether known as a communal sky garden or otherwise)	平方呎 sq.ft	不適用 Not applicable		
	平方米 sq.m			
位於期數中的建築物的最低一層住宅樓層以下的、供住客使用的公用花園或遊樂地方（不論是稱為有蓋及園景的遊樂場或有其他名稱） Communal garden or play area for residents' use below the lowest residential floor of a building in the Phase (whether known as a covered and landscaped play area or otherwise)	平方呎 sq.ft	14,204	29,011	43,215
	平方米 sq.m	1,319.546	2,695.210	4,014.756

備註：

以平方呎列出的面積均依據1平方米=10.764平方呎換算，並四捨五入至整數。

Note:

Areas in square feet are converted at a rate of 1 square metre to 10.764 square feet and rounded off to the nearest integer.

22 閱覽圖則及公契 INSPECTION OF PLANS AND DEED OF MUTUAL COVENANT

- 備有關乎本發展項目的分區計劃大綱圖的文本供閱覽的互聯網網站的網址為：www.ozp.tpb.gov.hk。
- (a) 指明住宅物業的每一已簽立公契的文本存放在指明住宅物業的售樓處，以供閱覽。
- (b) 無須為閱覽付費。

- The address of the website on which a copy of the Outline Zoning Plan relating to the Development is available: www.ozp.tpb.gov.hk.
- (a) A copy of every deed of mutual covenant in respect of the specified residential properties that has been executed is available for inspection at the place at which the specified residential properties are offered to be sold.
- (b) The inspection is free of charge.

1. 外部裝修物料				
細項	描述			
(a) 外牆	裝修物料的類型	外露部份髹外牆油漆、外牆瓦、鋁質掛飾、鋁質百葉及玻璃幕牆。		
(b) 窗	框的用料	鋁質窗框		
	玻璃的用料	鋁窗採用雙層中空玻璃配低幅射鍍膜，單片磨砂玻璃及單片清玻璃。 玻璃幕牆採用雙層中空玻璃配低幅射鍍膜。		
(c) 窗台	用料	不適用		
	窗台板的裝修物料	不適用		
(d) 花槽	裝修物料的類型	不適用		
(e) 陽台或露台	裝修物料的類型	(i) 露台		
		圍欄	天花	牆身
	夾層玻璃欄河及鋁質扶手，圍邊鋪砌鋁質掛飾及瓷磚	<p>外露部份髹外牆油漆，以下單位除外：</p> <p>以下單位外露部份髹外牆油漆及鋁板天花：</p> <p>第1座(1A)：5樓至8樓及31樓A及B單位 第1座(1B)：5樓至8樓、10樓至11樓、22樓至23樓及25樓至31樓A單位及5樓至8樓、10樓至12樓、15樓至23樓及25樓至31樓B單位</p> <p>以下單位外露部份髹外牆油漆及隔音天花：</p> <p>第1座(1A)：10樓至12樓、15樓至23樓及25樓至30樓A及B單位 第1座(1B)：12樓及15樓至21樓A單位</p>	<p>瓷磚，以下單位除外：</p> <p>以下單位鋪砌鋁質掛飾：</p> <p>第1座(1A)：5樓至7樓、10樓至12樓、15樓至23樓及25樓至30樓A及B單位及32樓A單位 第1座(1B)：5樓至8樓、12樓及15樓至21樓A單位、5樓至8樓及10樓B單位及32樓A及C單位</p> <p>第2座(2A)：5樓至8樓、10樓至12樓、15樓至23樓、25樓至33樓及35樓至37樓A、B、C及D單位及38樓A及B單位 第2座(2B)：5樓至8樓、10樓至12樓、15樓至23樓、25樓至33樓及35樓至36樓A單位及37樓及38樓A單位(複式)</p> <p>以下單位鋪砌隔音板：</p> <p>第1座(1A)：8樓及31樓A及B單位 第1座(1B)：10樓至11樓、22樓至23樓及25樓至31樓A單位及11樓至12樓、15樓至23樓及25樓至31樓B單位</p>	瓷磚
是否有蓋	<p>(ii) 期數不設陽台</p> <p>所有露台有蓋，以下單位除外：</p> <p>以下單位露台部分有蓋： 第1座(1B)：31樓F單位</p> <p>以下單位露台沒有蓋： 第1座(1A)：31樓C、D及E單位 第1座(1B)：31樓D單位 第2座(2A)：37樓A、B、C、D、E及F單位 第2座(2B)：37樓B、C、E、F及G單位</p>			
(f) 乾衣設施	類型及用料	不適用		

備註：

- 第1座(1A及1B)不設13樓、14樓及24樓，9樓為庇護層。
- 第2座(2A及2B)不設13樓、14樓、24樓及34樓，9樓為庇護層。

1. Exterior finishes										
Item	Description									
(a) External wall	Type of finishes	External wall paint to exposed surface, external wall tiles, aluminium cladding, aluminium louvre and curtain wall.								
(b) Window	Material of the frame	Aluminium window frame								
	Material of the glass	Insulated glass unit (IGU) glass panels with low emissivity coating, single glazing with sandblasted finish and single clear glazing for aluminium window. Insulated glass unit (IGU) with low emissivity coating for curtain wall.								
(c) Bay window	Material	Not applicable								
	Window sill finishes	Not applicable								
(d) Planter	Type of finishes	Not applicable								
(e) Verandah or balcony	Type of finishes	(i) Balcony								
		<table border="1"> <thead> <tr> <th>Balustrade</th> <th>Ceiling</th> <th>Wall</th> <th>Floor</th> </tr> </thead> <tbody> <tr> <td>Laminated glass balustrade fitted with aluminium railing. Curb finished with aluminium cladding and tiles</td> <td> <p>External wall paint to exposed surface. The following units are excepted:</p> <p>External wall paint to exposed surface and aluminium ceiling applicable to the following units: Units A and B on 5/F-8/F & 31/F of Tower 1 (1A) Units A on 5/F-8/F, 10/F - 11/F, 22/F- 23/F & 25/F-31/F and Unit B on 5/F-8/F, 10/F-12/E, 15/F-23/F & 25/F-31/F of Tower 1 (1B)</p> <p>External wall paint to exposed surface and Acoustic ceiling applicable to the following units: Units A and B on 10/F-12/F, 15/F-23/F & 25/F-30/F of Tower 1 (1A) Unit A on 12/F & 15/F-21/F of Tower 1 (1B)</p> </td> <td> <p>Tiles. The following units are excepted:</p> <p>Aluminium cladding applicable to the following units: Units A and B on 5/F-7/F, 10/F-12/F, 15/F-23/F & 25/F-30/F and Unit A on 32/F of Tower 1 (1A) Unit A on 5/F-8/F, 12/F & 15/F-21/F and Unit B on 5/F-8/F & 10/F and Units A and C on 32/F of Tower 1 (1B) Units A, B, C and D on 5/F-8/F, 10/F-12/F, 15/F-23/F, 25/F-33/F & 35/F-37/F and Units A and B on 38/F of Tower 2 (2A) Unit A on 5/F-8/F, 10/F-12/F, 15/F-23/F, 25/F-33/F & 35/F-36/F and Unit A on 37/F & 38/F (duplex) of Tower 2 (2B)</p> <p>Acoustic panel applicable to the following units: Units A and B on 8/F & 31/F of Tower 1 (1A) Unit A on 10/F-11/F, 22/F, 23/F & 25/F-31/F and Unit B on 11/F-12/F, 15/F-23/F & 25/F-31/F of Tower 1 (1B)</p> </td> <td>Tiles</td> </tr> </tbody> </table>	Balustrade	Ceiling	Wall	Floor	Laminated glass balustrade fitted with aluminium railing. Curb finished with aluminium cladding and tiles	<p>External wall paint to exposed surface. The following units are excepted:</p> <p>External wall paint to exposed surface and aluminium ceiling applicable to the following units: Units A and B on 5/F-8/F & 31/F of Tower 1 (1A) Units A on 5/F-8/F, 10/F - 11/F, 22/F- 23/F & 25/F-31/F and Unit B on 5/F-8/F, 10/F-12/E, 15/F-23/F & 25/F-31/F of Tower 1 (1B)</p> <p>External wall paint to exposed surface and Acoustic ceiling applicable to the following units: Units A and B on 10/F-12/F, 15/F-23/F & 25/F-30/F of Tower 1 (1A) Unit A on 12/F & 15/F-21/F of Tower 1 (1B)</p>	<p>Tiles. The following units are excepted:</p> <p>Aluminium cladding applicable to the following units: Units A and B on 5/F-7/F, 10/F-12/F, 15/F-23/F & 25/F-30/F and Unit A on 32/F of Tower 1 (1A) Unit A on 5/F-8/F, 12/F & 15/F-21/F and Unit B on 5/F-8/F & 10/F and Units A and C on 32/F of Tower 1 (1B) Units A, B, C and D on 5/F-8/F, 10/F-12/F, 15/F-23/F, 25/F-33/F & 35/F-37/F and Units A and B on 38/F of Tower 2 (2A) Unit A on 5/F-8/F, 10/F-12/F, 15/F-23/F, 25/F-33/F & 35/F-36/F and Unit A on 37/F & 38/F (duplex) of Tower 2 (2B)</p> <p>Acoustic panel applicable to the following units: Units A and B on 8/F & 31/F of Tower 1 (1A) Unit A on 10/F-11/F, 22/F, 23/F & 25/F-31/F and Unit B on 11/F-12/F, 15/F-23/F & 25/F-31/F of Tower 1 (1B)</p>	Tiles
	Balustrade	Ceiling	Wall	Floor						
Laminated glass balustrade fitted with aluminium railing. Curb finished with aluminium cladding and tiles	<p>External wall paint to exposed surface. The following units are excepted:</p> <p>External wall paint to exposed surface and aluminium ceiling applicable to the following units: Units A and B on 5/F-8/F & 31/F of Tower 1 (1A) Units A on 5/F-8/F, 10/F - 11/F, 22/F- 23/F & 25/F-31/F and Unit B on 5/F-8/F, 10/F-12/E, 15/F-23/F & 25/F-31/F of Tower 1 (1B)</p> <p>External wall paint to exposed surface and Acoustic ceiling applicable to the following units: Units A and B on 10/F-12/F, 15/F-23/F & 25/F-30/F of Tower 1 (1A) Unit A on 12/F & 15/F-21/F of Tower 1 (1B)</p>	<p>Tiles. The following units are excepted:</p> <p>Aluminium cladding applicable to the following units: Units A and B on 5/F-7/F, 10/F-12/F, 15/F-23/F & 25/F-30/F and Unit A on 32/F of Tower 1 (1A) Unit A on 5/F-8/F, 12/F & 15/F-21/F and Unit B on 5/F-8/F & 10/F and Units A and C on 32/F of Tower 1 (1B) Units A, B, C and D on 5/F-8/F, 10/F-12/F, 15/F-23/F, 25/F-33/F & 35/F-37/F and Units A and B on 38/F of Tower 2 (2A) Unit A on 5/F-8/F, 10/F-12/F, 15/F-23/F, 25/F-33/F & 35/F-36/F and Unit A on 37/F & 38/F (duplex) of Tower 2 (2B)</p> <p>Acoustic panel applicable to the following units: Units A and B on 8/F & 31/F of Tower 1 (1A) Unit A on 10/F-11/F, 22/F, 23/F & 25/F-31/F and Unit B on 11/F-12/F, 15/F-23/F & 25/F-31/F of Tower 1 (1B)</p>	Tiles							
(ii) No verandah in the Phase										
	Whether it is covered	<p>All balconies are covered, the following units are excepted:</p> <p>Balconies are partially covered for the following units: Unit F on 31/F of Tower 1 (1B)</p> <p>Balconies are not covered for the following units: Units C, D and E on 31/F of Tower 1 (1A) Unit D on 31/F of Tower 1 (1B) Units A, B, C, D, E and F on 37/F of Tower 2 (2A) Units B, C, E, F and G on 37/F of Tower 2 (2B)</p>								
(f) Drying facilities for clothing	Type and material	Not applicable								

Notes:

- 13/F, 14/F and 24/F are omitted in Tower 1 (1A and 1B) and 9/F is refuge floor.
- 13/F, 14/F, 24/F and 34/F are omitted in Tower 2 (2A and 2B) and 9/F is refuge floor.

2. 室內裝修物料					
細項	描述	牆壁裝修物料的類型			天花板裝修物料的類型
		牆壁裝修物料的類型	地板裝修物料的類型	天花板裝修物料的類型	
(a) 大堂	平台層住宅入口大堂及升降機大堂	天然石、木皮飾面及金屬面板、樹脂面板	天然石	石膏板及玻璃纖維石膏板假天花，外露部份髹乳膠漆	
	穿梭升降機大堂(2樓、3樓及平台層)	天然石、木皮飾面及金屬面板	天然石	石膏板及玻璃纖維石膏板假天花，外露部份髹乳膠漆	
	停車場穿梭升降機大堂(3樓及平台層)	天然石、木皮飾面及金屬面板	天然石	石膏板及玻璃纖維石膏板假天花，外露部份髹乳膠漆	
	住宅升降機大堂 (第1座(1A及1B)：5樓至8樓、10樓至12樓、15樓至23樓及25樓至32樓) (第2座(2A及2B)：5樓至8樓、10樓至12樓、15樓至23樓、25樓至33樓及35樓至38樓)	天然石、木皮飾面、金屬面板及玻璃面板	天然石	石膏板及玻璃纖維石膏板假天花，外露部份髹乳膠漆	
		牆壁裝修物料的類型		天花板裝修物料的類型	
(b) 內牆及天花板	客廳及飯廳	<p>乳膠漆(第1座(1A)27樓A單位及第2座(2A)27樓F單位及第2座(2B)37樓及38樓A單位(複式)除外)</p> <p>人造皮、天然石、鏡、牆紙、金屬、高光油漆及木飾面 適用於第1座(1A)27樓A單位</p> <p>乳膠漆及牆紙 適用於第2座(2A)27樓F單位</p> <p>金屬、高光油漆、牆紙、天然石、鏡及木飾面 適用於第2座(2B)37樓及38樓A單位(複式)</p>		外露部份髹乳膠漆，部份天花位置裝設石膏板假天花、假陣髹乳膠漆	
	睡房	<p>乳膠漆(第1座(1A)27樓A單位及第2座(2B)37樓及38樓A單位(複式)除外)</p> <p>主人睡房：金屬、鏡、牆紙及木飾面 睡房1：木飾面、牆紙及布面板 睡房2：牆紙、木飾面、布面板及金屬 睡房3：木飾面、金屬及牆紙 適用於第1座(1A)27樓A單位</p> <p>主人睡房：木飾面、金屬、高光油漆、牆紙及鏡 睡房1：木飾面、牆紙及鏡 睡房2：木飾面、金屬、牆紙及鏡 適用於第2座(2B)37樓及38樓A單位(複式)</p>		外露部份髹乳膠漆，部份天花位置裝設石膏板假天花、假陣髹乳膠漆	

備註：

- 第1座(1A及1B)不設13樓、14樓及24樓，9樓為庇護層。
- 第2座(2A及2B)不設13樓、14樓、24樓及34樓，9樓為庇護層。

2. Interior finishes				
Item	Description	Type of finishes		
		Type of wall finishes	Type of floor finishes	Type of ceiling finishes
(a) Lobby	Podium floor residential entrance lobby and lift lobby	Natural stone, wood veneer, metal panel and resin panel	Natural stone	Gypsum board and glass reinforced gypsum false ceiling finished with emulsion paint on exposed surface
	Shuttle lift lobby (2/F, 3/F and Podium floor)	Natural stone, wood veneer and metal panel	Natural stone	Gypsum board and glass reinforced gypsum false ceiling finished with emulsion paint on exposed surface
	Car park shuttle lift lobby (3/F and Podium floor)	Natural stone, wood veneer and metal panel	Natural stone	Gypsum board and glass reinforced gypsum false ceiling finished with emulsion paint on exposed surface
	Residential lift lobby (Tower 1 (1A and 1B) : 5/F-8/F, 10/F-12/F, 15/F-23/F & 25/F-32/F) (Tower 2 (2A and 2B) : 5/F-8/F, 10/F-12/F, 15/F-23/F, 25/F-33/F & 35/F-38/F)	Natural stone, wood veneer, metal panel and glass panel	Natural stone	Gypsum board and glass reinforced gypsum false ceiling finished with emulsion paint on exposed surface
		Type of wall finishes	Type of ceiling finishes	
(b) Internal wall and ceiling	Living room and dining room	Emulsion paint (except for Unit A on 27/F of Tower 1 (1A), Unit F on 27/F of Tower 2 (2A) and Unit A on 37/F & 38/F (Duplex) of Tower 2 (2B)) Artificial leather, natural stone, mirror, wallpaper, metal, high-gloss paint and wood veneer Applicable to Unit A on 27/F of Tower 1 (1A) Emulsion paint and wallpaper Applicable to Unit F on 27/F of Tower 2(2A) Metal, high-gloss paint, wallpaper, natural stone, mirror and wood veneer Applicable to Unit A on 37/F & 38/F (Duplex) of Tower 2 (2B)		Emulsion paint to exposed surfaces. Partial areas of the ceiling equipped with gypsum board false ceiling and bulkhead finished with emulsion paint
	Bedroom	Emulsion paint (except for Unit A on 27/F of Tower 1 (1A) and Unit A on 37/F & 38/F (Duplex) of Tower 2 (2B)) Master Bedroom: Metal, mirror, wallpaper and wood veneer Bedroom 1: Wood veneer, wallpaper and fabric panel Bedroom 2: Wallpaper, wood veneer, fabric panel and metal Bedroom 3: Wood veneer, metal and wallpaper Applicable to Unit A on 27/F of Tower 1 (1A) Master Bedroom: Wood veneer, metal, high-gloss paint, wallpaper and mirror Bedroom 1: Wood veneer, wallpaper and mirror Bedroom 2: Wood veneer, metal, wallpaper and mirror Applicable to Unit A on 37/F & 38/F (Duplex) of Tower 2 (2B)		Emulsion paint to exposed surfaces. Partial areas of the ceiling equipped with gypsum board false ceiling and bulkhead finished with emulsion paint

Notes:

- 13/F, 14/F and 24/F are omitted in Tower 1 (1A and 1B) and 9/F is refuge floor.
- 13/F, 14/F, 24/F and 34/F are omitted in Tower 2 (2A and 2B) and 9/F is refuge floor.

2. 室內裝修物料			
細項	描述	地板用料	
		地板用料	牆腳線用料
(c) 內部地板	客廳、飯廳及睡房	<p>瓷磚地板，於露台門（如有）、工作平台門（如有）、平台門（如有）及花園門（如有）旁鋪上人造合成石及金屬分隔條 適用於以下單位： 第1座(1A)：5樓至8樓、10樓至12樓、15樓至23樓及25樓至31樓C及E單位 第1座(1B)：5樓至8樓、10樓至12樓、15樓至23樓及25樓至31樓D、E及F單位 第2座(2A)：5樓至8樓、10樓至12樓、15樓至23樓、25樓至33樓及35樓至37樓E單位 第2座(2B)：5樓至8樓C及G單位、6樓至8樓D及F單位及10樓至12樓、15樓至23樓、25樓至33樓及35樓至37樓F及G單位</p> <p>複合木地板，於露台門（如有）、工作平台門（如有）、平台門（如有）及花園門（如有）旁鋪上人造合成石及金屬分隔條 適用於以下單位： 第1座(1A)：5樓至8樓、10樓至12樓、15樓至23樓、25樓至26樓及28樓至31樓A單位、5樓至8樓、10樓至12樓、15樓至23樓及25樓至31樓B及D單位 第1座(1B)：5樓至8樓、10樓至12樓、15樓至23樓及25樓至31樓A、B及C單位 第2座(2A)：5樓至8樓、10樓至12樓、15樓至23樓、25樓至33樓及35樓至37樓A、B、C、D及F單位 第2座(2B)：5樓至8樓、10樓至12樓、15樓至23樓、25樓至33樓、35樓至36樓A及B單位、37樓B單位、10樓至12樓、15樓至23樓、25樓至33樓及35樓至37樓C單位及6樓至8樓、10樓至12樓、15樓至23樓、25樓至33樓及35樓至37樓E單位</p> <p>複合木地板，於露台門（如有）、工作平台門（如有）及平台門（如有）旁鋪上天然石及金屬分隔條 適用於以下單位： 第1座(1A)：32樓A及B單位 第1座(1B)：32樓A、B及C單位 第2座(2A)：38樓A、B及C單位 第2座(2B)：38樓B及C單位</p> <p>客飯廳鋪上天然石，於露台門（如有）、工作平台門（如有）及平台門（如有）旁鋪上金屬分隔條及睡房鋪上複合木地板 適用於以下單位： 第1座(1A)：27樓A單位 第2座(2B)：37樓及38樓A單位（複式）</p>	<p>木皮飾面牆腳線（第1座(1A)27樓A單位除外）</p> <p>客廳及飯廳：金屬牆腳線 主人睡房：木皮飾面牆腳線及金屬牆腳線 睡房1、2及3：木皮飾面牆腳線 適用於第1座(1A)27樓A單位</p>

備註：

- 第1座(1A及1B)不設13樓、14樓及24樓，9樓為庇護層。
- 第2座(2A及2B)不設13樓、14樓、24樓及34樓，9樓為庇護層。

2. Interior finishes			
Item	Description	Material of floor	
		Material of floor	Material of skirting
(c) Internal floor	Living room, dining room and bedroom	<p>Tile floorings, and finished with reconstituted stone and metal dividing strip next to balcony door (if provided), utility platform door (if provided), flat roof door (if provided) and garden door (if provided) Applicable to the following units: Units C and E on 5/F-8/F, 10/F-12/F, 15/F-23/F & 25/F-31/F of Tower 1 (1A) Units D, E and F on 5/F-8/F, 10/F-12/F, 15/F-23/F & 25/F-31/F of Tower 1 (1B) Unit E on 5/F-8/F, 10/F-12/F, 15/F-23/F, 25/F-33/F & 35/F-37/F of Tower 2 (2A) Units C and G on 5/F-8/F, Units D and F on 6/F-8/F and Units F and G on 10/F-12/F, 15/F-23/F, 25/F-33/F & 35/F-37/F of Tower 2 (2B)</p> <p>Engineered timber flooring, and finished with reconstituted stone and metal dividing strip next to balcony door (if provided), utility platform door (if provided), flat roof door (if provided) and garden door (if provided) Applicable to the following units: Unit A on 5/F-8/F, 10/F-12/F, 15/F-23/F, 25/F-26/F & 28/F-31/F and Units B and D on 5/F-8/F, 10/F-12/F, 15/F-23/F & 25/F-31/F of Tower 1 (1A) Units A, B and C on 5/F-8/F, 10/F-12/F, 15/F-23/F & 25/F-31/F of Tower 1 (1B) Units A, B, C, D and F on 5/F-8/F, 10/F-12/F, 15/F-23/F, 25/F-33/F & 35/F-37/F of Tower 2 (2A) Units A and B on 5/F-8/F, 10/F-12/F, 15/F-23/F, 25/F-33/F & 35/F-36/F, Unit B on 37/F, Unit C on 10/F-12/F, 15/F-23/F, 25/F-33/F & 35/F-37/F and Unit E on 6/F-8/F, 10/F-12/F, 15/F-23/F, 25/F-33/F & 35/F-37/F of Tower 2 (2B)</p> <p>Engineered timber floorings, and finished with natural stone and metal dividing strip next to balcony door (if provided), utility platform door (if provided) and flat roof door (if provided) Applicable to the following units: Units A and B on 32/F of Tower 1 (1A) Units A, B and C on 32/F of Tower 1 (1B) Units A, B and C on 38/F of Tower 2 (2A) Units B and C on 38/F of Tower 2 (2B)</p> <p>Natural stone floorings in living room and dining room and metal dividing strip next to balcony door (if provided), utility platform door (if provided) and flat roof door (if provided) and engineered timber floorings in bedrooms Applicable to the following units: Unit A on 27/F of Tower 1 (1A) Unit A on 37/F & 38/F (Duplex) of Tower 2 (2B)</p>	<p>Wood veneer skirting (except for Unit A on 27/F of Tower 1 (1A))</p> <p>Living room and dining room: Metal skirting Master Bedroom: Wood veneer skirting and metal skirting Bedroom 1,2 and 3: Wood veneer skirting Applicable to Unit A on 27/F of Tower 1 (1A)</p>

Notes:

1. 13/F, 14/F and 24/F are omitted in Tower 1 (1A and 1B) and 9/F is refuge floor.
2. 13/F, 14/F, 24/F and 34/F are omitted in Tower 2 (2A and 2B) and 9/F is refuge floor.

2. 室內裝修物料						
細項	描述	牆壁裝修物料的類型			地板裝修物料的類型	天花板裝修物料的類型
		(d) 浴室	裝修物料的類型	外露部份鋪砌天然石 (以下單位除外) 外露部份鋪砌天然石及鏡飾面 適用於以下單位： 第1座(1A): 27樓A單位 第2座(2B): 37樓及38樓A單位(複式)	外露部份鋪砌天然石	外露部份裝設石膏板假天花及髹乳膠漆
	牆壁的裝修物料是否鋪至天花板	鋪至假天花水平				
		牆壁裝修物料的類型	地板裝修物料的類型	天花板裝修物料的類型	灶台裝修物料的類型	
(e) 廚房	適用於以下單位： 第1座(1A)：5樓至8樓、10樓至12樓、15樓至23樓及25樓至31樓C及E單位 第1座(1B)：5樓至8樓、10樓至12樓、15樓至23樓及25樓至31樓D、E及F單位 第2座(2A)：5樓至8樓、10樓至12樓、15樓至23樓、25樓至33樓及35樓至37樓E單位 第2座(2B)：5樓至8樓C及G單位、6樓至8樓D及F單位及10樓至12樓、15樓至23樓、25樓至33樓及35樓至37樓F及G單位	外露部份鋪砌實心面材	外露部份鋪砌瓷磚	外露部份髹乳膠漆，部份天花位置裝設石膏板假天花及假陣髹乳膠漆	實心面材	
	適用於以下單位： 第1座(1A)：5樓至8樓、10樓至12樓、15樓至23樓及25樓至31樓A、B及D單位 第1座(1B)：5樓至8樓、10樓至12樓、15樓至23樓及25樓至31樓A、B及C單位 第2座(2A)：5樓至8樓、10樓至12樓、15樓至23樓、25樓至33樓及35樓至37樓A、B、C、D及F單位 第2座(2B)：5樓至8樓、10樓至12樓、15樓至23樓、25樓至33樓及35樓至36樓A及B單位、37樓B單位、10樓至12樓、15樓至23樓、25樓至33樓及35樓至37樓C單位及6樓至8樓、10樓至12樓、15樓至23樓、25樓至33樓及35樓至37樓E單位	外露部份鋪砌瓷磚及玻璃面板	外露部份鋪砌天然石	外露部份裝設石膏板假天花及髹乳膠漆	實心面材	
	適用於以下單位： 第1座(1A)：32樓A及B單位 第1座(1B)：32樓A、B及C單位 第2座(2A)：38樓A、B及C單位 第2座(2B)：37樓及38樓A單位(複式)及38樓B及C單位	外露部份鋪砌天然石及玻璃面板	外露部份鋪砌天然石	外露部份裝設石膏板假天花及髹乳膠漆	人造合成石	
	牆壁的裝修物料是否鋪至天花板	鋪至假天花水平				

備註：

- 第1座(1A及1B)不設13樓、14樓及24樓，9樓為庇護層。
- 第2座(2A及2B)不設13樓、14樓、24樓及34樓，9樓為庇護層。

2. Interior finishes					
Item	Description				
		Type of wall finishes	Type of floor finishes	Type of ceiling finishes	
(d) Bathroom	Type of finishes	Natural stone on exposed surface (except the following units) Natural stone and mirror panel on exposed surface Applicable to the following units: Unit A on 27/F of Tower 1(1A) Unit A on 37/F & 38/F (Duplex) of Tower 2 (2B)	Natural stone on exposed surface	Gypsum board false ceiling and emulsion paint on exposed surface	
	Whether the wall finishes run up to ceiling	Up to false ceiling level			
		Type of wall finishes	Type of floor finishes	Type of ceiling finishes	Type of cooking bench finishes
(e) Kitchen	Applicable to the following units: Units C and E on 5/F-8/F, 10/F-12/F, 15/F-23/F & 25/F-31/F of Tower 1 (1A) Units D, E and F on 5/F-8/F, 10/F-12/F, 15/F-23/F & 25/F-31/F of Tower 1 (1B) Unit E on 5/F-8/F, 10/F-12/F, 15/F-23/F, 25/F-33/F & 35/F-37/F of Tower 2 (2A) Units C and G on 5/F-8/F, Units D and F on 6/F-8/F and Units F and G on 10/F-12/F, 15/F-23/F, 25/F-33/F & 35/F-37/F of Tower 2 (2B)	Solid surface material on exposed surface	Tiles on exposed surface	Emulsion paint on exposed surfaces. Partial area equipped with gypsum board false ceiling and bulkhead finished with emulsion paint	Solid surface material
	Applicable to the following units: Units A, B and D on 5/F-8/F, 10/F-12/F, 15/F-23/F & 25/F-31/F of Tower 1 (1A) Units A, B and C on 5/F-8/F, 10/F-12/F, 15/F-23/F & 25/F-31/F of Tower 1 (1B) Units A, B, C, D and F on 5/F-8/F, 10/F-12/F, 15/F-23/F, 25/F-33/F & 35/F-37/F of Tower 2 (2A) Units A and B on 5/F-8/F, 10/F-12/F, 15/F-23/F, 25/F-33/F & 35/F-36/F, Unit B on 37/F, Unit C on 10/F-12/F, 15/F-23/F, 25/F-33/F & 35/F-37/F and Unit E on 6/F-8/F, 10/F-12/F, 15/F-23/F, 25/F-33/F & 35/F-37/F of Tower 2 (2B)	Tiles and glass panel on exposed surface	Natural stone on exposed surface	Gypsum board false ceiling and emulsion paint on exposed surface	Solid surface material
	Applicable to the following units: Units A and B on 32/F of Tower 1 (1A) Units A, B and C on 32/F of Tower 1 (1B) Units A, B and C on 38/F of Tower 2 (2A) Unit A on 37/F & 38/F (Duplex) and Units B and C on 38/F of Tower 2 (2B)	Natural stone and glass panel on exposed surface	Natural stone on exposed surface	Gypsum board false ceiling and emulsion paint on exposed surface	Reconstituted stone
	Whether the wall finishes run up to ceiling	Up to false ceiling level			

Notes:

- 13/F, 14/F and 24/F are omitted in Tower 1 (1A and 1B) and 9/F is refuge floor.
- 13/F, 14/F, 24/F and 34/F are omitted in Tower 2 (2A and 2B) and 9/F is refuge floor.

3. 室內裝置					
細項	描述				
		用料	裝修物料	配件	
(a) 門	單位入口大門	實心防火木掩門	木皮飾面板	門鎖連門柄、防盜眼、氣鼓、防盜鏈、門擋及防煙條	
	睡房門	實心木掩門	木皮飾面板	門鎖連門柄及門擋	
	浴室門	(i) 空心木掩門 適用於以下單位： 第1座(1A)：5樓至8樓、10樓至12樓、15樓至23樓及25樓至31樓A、B、C及D單位及32樓A單位 第1座(1B)：5樓至8樓、10樓至12樓、15樓至23樓及25樓至31樓A、B、D及F單位及32樓A、B及C單位 第2座(2A)：5樓至8樓、10樓至12樓、15樓至23樓、25樓至33樓及35樓至37樓A、B、D及F單位及38樓A、B及C單位 第2座(2B)：5樓至8樓、10樓至12樓、15樓至23樓、25樓至33樓及35樓至36樓A單位、37樓及38樓A單位(複式)、5樓至8樓B及C單位、6樓至8樓D單位、10樓至12樓、15樓至23樓、25樓至33樓及35樓至37樓B及C單位及38樓B單位	木皮飾面板	(i) 門鎖連門柄、門擋及衣鈎 適用於以下單位： 第1座(1A)：5樓至8樓、10樓至12樓、15樓至23樓及25樓至31樓A、B、C、D及E單位及32樓A及B單位 第1座(1B)：5樓至8樓、10樓至12樓、15樓至23樓及25樓至31樓A、B、C、D、E及F單位及32樓A、B及C單位 第2座(2A)：5樓至8樓、10樓至12樓、15樓至23樓、25樓至33樓及35樓至37樓A、B、C、D、E及F單位及38樓A、B及C單位 第2座(2B)：5樓至8樓A、B、C及G單位、6樓至8樓D、E及F單位、10樓至12樓、15樓至23樓、25樓至33樓及35樓至36樓A、B、C、E、F及G單位、37樓B、C、E、F及G單位、37樓及38樓A單位(複式)及38樓B及C單位	
		(ii) 空心木掩門配木製百葉 適用於以下單位： 第1座(1A)：5樓至8樓、10樓至12樓、15樓至23樓及25樓至31樓D及E單位及32樓B單位 第1座(1B)：5樓至8樓、10樓至12樓、15樓至23樓、及25樓至31樓C及E單位及32樓A、B及C單位 第2座(2A)：5樓至8樓、10樓至12樓、15樓至23樓、25樓至33樓及35樓至37樓A、C及E單位及38樓A及B單位 第2座(2B)：10樓至12樓、15樓至23樓、25樓至33樓及35樓至38樓C單位、6樓至8樓、10樓至12樓、15樓至23樓、25樓至33樓及35樓至37樓E及F單位、5樓至8樓、10樓至12樓、15樓至23樓、25樓至33樓及35樓至37樓G單位、37樓及38樓A單位(複式)及38樓B單位			(ii) 門鎖連門柄 適用於以下單位： 第2座(2A)：5樓至8樓、10樓至12樓、15樓至23樓、25樓至33樓及35樓至37樓E單位 第2座(2B)：5樓至8樓、10樓至12樓、15樓至23樓、25樓至33樓及35樓至36樓A單位、6樓至8樓D單位、6樓至8樓、10樓至12樓、15樓至23樓、25樓至33樓及35樓至37樓F單位
		(iii) 空心木趟門 適用於以下單位： 第2座(2B)：5樓至8樓、10樓至12樓、15樓至23樓、25樓至33樓及35樓至36樓A單位			
(iv) 空心木趟門配木製百葉 只適用於以下單位： 第2座(2A)：5樓至8樓、10樓至12樓、15樓至23樓、25樓至33樓及35樓至37樓E單位 第2座(2B)：6樓至8樓D單位及6樓至8樓、10樓至12樓、15樓至23樓、25樓至33樓及35樓至37樓F單位					
廚房門	實心防火木掩門配防火玻璃視窗	木皮飾面板	門柄、氣鼓、門擋及防煙條		

備註：

- 第1座(1A及1B)不設13樓、14樓及24樓，9樓為庇護層。
- 第2座(2A及2B)不設13樓、14樓、24樓及34樓，9樓為庇護層。

3. Interior fittings				
Item	Description			
		Materials	Finishes	Accessories
(a) Doors	Unit main entrance door	Solid core fire rated timber swing door	Wood veneered panel	Lockset with door handle, eye viewer, door closer, door chain, door stopper and smoke seal
	Bedroom door	Solid core timber swing door	Wood veneered panel	Lockset with door handle and door stopper
	Bathroom door	(i) Hollow core timber swing door Applicable to the following units: Units A, B, C and D on 5/F-8/F, 10/F-12/F, 15/F-23/F & 25/F-31/F and Unit A on 32/F of Tower 1 (1A) Units A, B, D and F on 5/F-8/F, 10/F-12/F, 15/F-23/F & 25/F-31/F and Units A, B and C on 32/F of Tower 1 (1B) Units A, B, D and F on 5/F-8/F, 10/F-12/F, 15/F-23/F, 25/F-33/F & 35/F-37/F and Units A, B and C on 38/F of Tower 2 (2A) Unit A on 5/F-8/F, 10/F-12/F, 15/F-23/F, 25/F-33/F & 35/F-36/F, Unit A on 37/F and 38/F (Duplex), Units B and C on 5/F-8/F, Unit D on 6/F-8/F, Units B and C on 10/F-12/F, 15/F-23/F, 25/F-33/F & 35/F-37/F and Unit B on 38/F of Tower 2 (2B)	Wood veneered panel	(i) Lockset with door handle, door stopper and robe hook Applicable to the following units: Units A, B, C, D and E on 5/F-8/F, 10/F-12/F, 15/F-23/F & 25/F-31/F and Unit A and B on 32/F of Tower 1 (1A) Units A, B, C, D, E and F on 5/F-8/F, 10/F-12/F, 15/F-23/F & 25/F-31/F and Units A, B and C on 32/F of Tower 1 (1B) Units A, B, C, D, E and F on 5/F-8/F, 10/F-12/F, 15/F-23/F, 25/F-33/F & 35/F-37/F and Units A, B and C on 38/F of Tower 2 (2A) Units A, B, C and G on 5/F-8/F, Units D, E and F on 6/F-8/F, Units A, B, C, E, F and G on 10/F-12/F, 15/F-23/F, 25/F-33/F & 35/F-36/F, Units B, C, E, F and G on 37/F, Unit A on 37/F & 38/F (Duplex) and Units B and C on 38/F of Tower 2 (2B)
		(ii) Hollow core timber swing door with timber louvre Applicable to the following units: Units D and E on 5/F-8/F, 10/F-12/F, 15/F-23/F & 25/F-31/F and Unit B on 32/F of Tower 1(1A) Units C and E on 5/F-8/F, 10/F-12/F, 15/F-23/F & 25/F-31/F and Units A, B and C on 32/F of Tower 1 (1B) Units A,C and E on 5/F-8/F, 10/F-12/F, 15/F-23/F, 25/F-33/F & 35/F-37/F and Units A and B on 38/F of Tower 2 (2A) Unit C on 10/F-12/F, 15/F-23/F, 25/F-33/F & 35/F-38/F and Units E and F on 6/F-8/F, 10/F-12/F, 15/F-23/F, 25/F-33/F & 35/F-37/F, Unit G on 5/F-8/F, 10/F-12/F, 15/F-23/F, 25/F-33/F & 35/F-37/F, Unit A on 37/F & 38/F (Duplex) and Unit B on 38/F of Tower 2 (2B)		
		(iii) Hollow core timber sliding door Applicable to the following units: Unit A on 5/F-8/F, 10/F-12/F, 15/F-23/F, 25/F-33/F & 35/F-36/F of Tower 2 (2B)		
(iv) Hollow core timber sliding door with timber louvre Applicable to the following units: Unit E on 5/F-8/F, 10/F-12/F, 15/F-23/F, 25/F-33/F & 35/F-37/F of Tower 2 (2A) Unit D on 6/F-8/F and Unit F on 6/F-8/F, 10/F-12/F, 15/F-23/F, 25/F-33/F & 35/F-37/F of Tower 2 (2B)				
Kitchen door	Solid core fire rated timber swing door with fire rated glass vision panel	Wood veneered panel		

Notes:

- 13/F, 14/F and 24/F are omitted in Tower 1 (1A and 1B) and 9/F is refuge floor.
- 13/F, 14/F, 24/F and 34/F are omitted in Tower 2 (2A and 2B) and 9/F is refuge floor.

3. 室內裝置				
細項	描述	用料		
		用料	裝修物料	配件
(a) 門	士多房門	(i) 空心木掩門 適用於以下單位： 第1座(1A)：5樓至8樓、10樓至12樓、15樓至23樓及25樓至31樓B單位及32樓A單位 第2座(2A)：38樓B及C單位 第2座(2B)：10樓至12樓、15樓至23樓、25樓至33樓及35樓至38樓C單位及37樓及38樓A單位（複式）	木皮飾面板	(i) 門鎖連門柄及門擋 適用於以下單位： 第1座(1A)：5樓至8樓、10樓至12樓、15樓至23樓及25樓至32樓A及B單位 第1座(1B)：5樓至8樓、10樓至12樓、15樓至23樓及25樓至32樓A及B單位 第2座(2A)：5樓至8樓、10樓至12樓、15樓至23樓、25樓至33樓及35樓至37樓A、B、C及D單位及38樓B及C單位 第2座(2B)：10樓至12樓、15樓至23樓、25樓至33樓及35樓至37樓C單位、37樓及38樓A單位（複式）及38樓B及C單位
		(ii) 空心木掩門配木製百葉 適用於以下單位： 第1座(1A)：5樓至8樓、10樓至12樓、15樓至23樓及25樓至31樓A單位及32樓B單位 第1座(1B)：5樓至8樓、10樓至12樓、15樓至23樓及25樓至32樓A及B單位 第2座(2A)：5樓至8樓、10樓至12樓、15樓至23樓、25樓至33樓及35樓至37樓A、B、C及D單位及38樓B及C單位 第2座(2B)：37樓及38樓A單位（複式）及38樓B及C單位		
		(iii) 空心木趟門配木製百葉 適用於以下單位： 第1座(1A)：32樓A單位 第2座(2A)：38樓A單位		
		(iv) 空心木趟門 適用於以下單位： 第1座(1B)：32樓C單位		
		(v) 鋁框玻璃掩門 適用於以下單位： 第1座(1B)：32樓A單位		
	走廊門（只適用於第2座(2A)38樓B單位）	空心木掩門配木製百葉	木皮飾面板	門柄及門擋
平台門	(i) 鋁框玻璃趟摺門 適用於以下單位： 第1座(1A)：32樓A及B單位 第1座(1B)：32樓A單位 第2座(2A)：38樓A及B單位 第2座(2B)：38樓B單位	雙層中空玻璃配低幅射鍍膜 適用於以下單位： 第1座(1B)：32樓A單位	(i) 門鎖連門柄 適用於以下單位： 第1座(1A)：32樓A及B單位 第1座(1B)：32樓A單位 第2座(2A)：38樓A及B單位 第2座(2B)：38樓B單位	
	(ii) 鋁框玻璃掩門 適用於以下單位： 第1座(1A)：32樓A及B單位 第1座(1B)：32樓A單位 第2座(2A)：38樓C單位			(ii) 門鎖連門柄及門擋 適用於以下單位： 第1座(1A)：32樓A及B單位 第1座(1B)：32樓A單位 第2座(2A)：38樓C單位

備註：

- 第1座（1A及1B）不設13樓、14樓及24樓，9樓為庇護層。
- 第2座（2A及2B）不設13樓、14樓、24樓及34樓，9樓為庇護層。

3. Interior fittings				
Item	Description			
		Materials	Finishes	Accessories
(a) Doors	Store door	(i) Hollow core timber swing door Applicable to the following units: Unit B on 5/F-8/F, 10/F-12/F, 15/F-23/F & 25/F-31/F and Unit A on 32/F of Tower 1 (1A) Units B and C on 38/F of Tower 2 (2A) Unit C on 10/F-12/F, 15/F-23/F, 25/F-33/F & 35/F-38/F and Unit A on 37/F & 38/F (Duplex) of Tower 2 (2B)	Wood veneered panel	(i) Lockset with door handle and door stopper Applicable to the following units: Units A and B on 5/F-8/F, 10/F-12/F, 15/F-23/F & 25/F-32/F of Tower 1 (1A) Units A and B on 5/F-8/F, 10/F-12/F, 15/F-23/F & 25/F-32/F of Tower 1 (1B) Units A, B, C and D on 5/F-8/F, 10/F-12/F, 15/F-23/F, 25/F-33/F & 35/F-37/F and Units B and C on 38/F of Tower 2 (2A) Unit C on 10/F-12/F, 15/F-23/F, 25/F-33/F & 35/F-37/F, Unit A on 37/F & 38/F (Duplex) and Units B and C on 38/F of Tower 2 (2B)
		(ii) Hollow core timber swing door with timber louvre Applicable to the following units: Unit A on 5/F-8/F, 10/F-12/F, 15/F-23/F & 25/F-31/F and Unit B on 32/F of Tower 1 (1A) Units A and B on 5/F-8/F, 10/F-12/F, 15/F-23/F & 25/F-32/F of Tower 1 (1B) Units A, B, C and D on 5/F-8/F, 10/F-12/F, 15/F-23/F, 25/F-33/F & 35/F-37/F and Units B and C on 38/F of Tower 2 (2A) Unit A on 37/F & 38/F (Duplex) and Units B and C on 38/F of Tower 2 (2B)		(ii) Lockset with door handle Applicable to the following units: Unit A on 32/F of Tower 1 (1A) Unit C on 32/F of Tower 1 (1B) Unit A on 38/F of Tower 2 (2A)
		(iii) Hollow core timber sliding door with timber louvre Applicable to the following units: Unit A on 32/F of Tower 1 (1A) Unit A on 38/F of Tower 2 (2A)		(iii) Lockset with door handle and door closer Applicable to the following unit: Unit A on 32/F of Tower 1 (1B)
		(iv) Hollow core timber sliding door Applicable to the following unit: Unit C on 32/F of Tower 1 (1B)		
		(v) Aluminium framed glass swing door Applicable to the following unit: Unit A on 32/F of Tower 1 (1B)		Insulated glass unit (IGU) glass panels with low-e coating Applicable to the following unit: Unit A on 32/F of Tower 1 (1B)
	Corridor door (Applicable to Unit B on 38/F of Tower 2 (2A) only)	Hollow core timber swing door with timber louvre	Wood veneered panel	Door handle and door stopper
	Flat roof door	(i) Aluminium framed glass bi-folding door Applicable to the following units: Units A and B on 32/F of Tower 1 (1A) Unit A on 32/F of Tower 1 (1B) Units A and B on 38/F of Tower 2 (2A) Unit B on 38/F of Tower 2 (2B)	Insulated glass unit (IGU) glass panels with low-e coating	(i) Lockset with door handle Applicable to the following units: Units A and B on 32/F of Tower 1 (1A) Unit A on 32/F of Tower 1 (1B) Units A and B on 38/F of Tower 2 (2A) Unit B on 38/F of Tower 2 (2B)
(ii) Aluminium framed glass swing door Applicable to the following units: Units A and B on 32/F of Tower 1 (1A) Unit A on 32/F of Tower 1 (1B) Unit C on 38/F of Tower 2 (2A)		(ii) Lockset with door handle and door stopper Applicable to the following units: Units A and B on 32/F of Tower 1 (1A) Unit A on 32/F of Tower 1 (1B) Unit C on 38/F of Tower 2 (2A)		

Notes:

- 13/F, 14/F and 24/F are omitted in Tower 1 (1A and 1B) and 9/F is refuge floor.
- 13/F, 14/F, 24/F and 34/F are omitted in Tower 2 (2A and 2B) and 9/F is refuge floor.

3. 室內裝置				
細項	描述	用料		
		用料	裝修物料	配件
(a) 門	露天平台門 (只適用於第2座(2A)38樓A單位)	鋁框玻璃趟門	雙層中空玻璃配低幅射鍍膜	門鎖連門柄
	露台門	鋁框玻璃趟門	雙層中空玻璃配低幅射鍍膜	門鎖連門柄
	工作平台門	鋁框玻璃掩門	雙層中空玻璃配低幅射鍍膜	(i) 門鎖連門柄及門擋 以下單位除外： 第1座(1A)：12樓、15樓至23樓及25樓至31樓B單位及 第2座(2B)：6樓至8樓、10樓至12樓、15樓至23樓、25樓至33樓及35樓至36樓A單位
				(ii) 門鎖連門柄及隱藏式氣鼓 適用於第1座(1A)：12樓、15樓至23樓及25樓至31樓B單位
				(iii) 門鎖連門柄及氣鼓 適用於第2座(2B)：6樓至8樓、10樓至12樓、15樓至23樓、25樓至33樓及35樓至36樓A單位
	洗手間門	鋁框玻璃趟摺門	磨砂玻璃	門鎖連門柄
	私人花園門	(i) 鋁框玻璃趟門 適用於以下單位： 第1座(1A)：5樓A、B、C、D及E單位 第1座(1B)：5樓A、B、C、D、E及F單位 第2座(2A)：5樓A、B、C、D及F單位 第2座(2B)：5樓A及B單位	雙層中空玻璃配低幅射鍍膜	(i) 門鎖連門柄 適用於以下單位： 第1座(1A)：5樓A、B、C、D及E單位 第1座(1B)：5樓A、B、C、D、E及F單位 第2座(2A)：5樓A、B、C、D及F單位 第2座(2B)：5樓A及B單位
		(ii) 鋁框玻璃掩門 適用於以下單位： 第1座(1A)：5樓D單位 第2座(2A)：5樓A單位		(ii) 門鎖連門柄及門擋 適用於以下單位： 第1座(1A)：5樓D單位 第2座(2A)：5樓A單位
私人天台門 適用於以下單位： 第1座(1A)：32樓B單位 第1座(1B)：32樓B及C單位 第2座(2A)：38樓A、B及C單位 第2座(2B)：37樓及38樓A單位(複式) 及38樓B及C單位	鋁框玻璃掩門	雙層中空玻璃配低幅射鍍膜	門鎖連門柄及氣鼓	

備註：

- 第1座(1A及1B)不設13樓、14樓及24樓，9樓為庇護層。
- 第2座(2A及2B)不設13樓、14樓、24樓及34樓，9樓為庇護層。

3. Interior fittings				
Item	Description			
		Materials	Finishes	Accessories
(a) Doors	Open flat roof door (Applicable to Unit A on 38/F of Tower 2 (2A) only)	Aluminium framed glass sliding door	Insulated glass unit (IGU) glass panels with low-e coating	Lockset with door handle
	Balcony door	Aluminium framed glass sliding door	Insulated glass unit (IGU) glass panels with low-e coating	Lockset with door handle
	Utility platform door	Aluminium framed glass swing door	Insulated glass unit (IGU) glass panels with low-e coating	(i) Lockset with door handle and door stopper Except for Unit B on 12/F, 15/F-23/F & 25/F-31/F of Tower 1 (1A) and Unit A on 6/F-8/F, 10/F-12/F, 15/F-23/F, 25/F-33/F & 35/F-36/F of Tower 2 (2B)
				(ii) Lockset with door handle and concealed door closer Applicable to Unit B on 12/F, 15/F-23/F & 25/F-31/F of Tower 1 (1A)
				(iii) Lockset with door handle and door closer Applicable to Unit A on 6/F-8/F, 10/F-12/F, 15/F-23/F, 25/F-33/F & 35/F-36/F of Tower 2 (2B)
	Lavatory door	Aluminium frame glass bi-folding door	Sandblasted glass	Lockset with door handle
	Private garden door	(i) Aluminium framed glass sliding door Applicable to the following units: Units A, B, C, D and E on 5/F of Tower 1 (1A) Units A, B, C, D, E and F on 5/F of Tower 1 (1B) Units A, B, C, D and F on 5/F of Tower 2 (2A) Units A and B on 5/F of Tower 2 (2B)	Insulated glass unit (IGU) glass panels with low-e coating	(i) Lockset with door handle Applicable to the following units: Units A, B, C, D and E on 5/F of Tower 1 (1A) Units A, B, C, D, E and F on 5/F of Tower 1 (1B) Units A, B, C, D and F on 5/F of Tower 2 (2A) Units A and B on 5/F of Tower 2 (2B)
(ii) Aluminium framed glass swing door Applicable to the following units: Unit D on 5/F of Tower 1 (1A) Unit A on 5/F of Tower 2 (2A)		(ii) Lockset with door handle and door stopper Applicable to the following units: Unit D on 5/F of Tower 1 (1A) Unit A on 5/F of Tower 2 (2A)		
Private roof door Applicable to the following units: Unit B on 32/F of Tower 1 (1A) Units B and C on 32/F of Tower 1 (1B) Units A, B and C on 38/F of Tower 2 (2A) Unit A on 37/F & 38/F (Duplex) and Units B and C on 38/F of Tower 2 (2B)	Aluminium framed glass swing door	Insulated glass unit (IGU) glass panels with low-e coating	Lockset with door handle and door closer	

Notes:

- 13/F, 14/F and 24/F are omitted in Tower 1 (1A and 1B) and 9/F is refuge floor.
- 13/F, 14/F, 24/F and 34/F are omitted in Tower 2 (2A and 2B) and 9/F is refuge floor.

3. 室內裝置			
細項	描述	類型	
		類型	用料
(b) 浴室	(i) 裝置及設備	洗面盆櫃檯面	天然石
		洗面盆櫃	木製洗面盆櫃配膠板及金屬條
		鏡櫃	不銹鋼製鏡櫃配鏡面板連玻璃層板
		洗面盆水龍頭	鍍鉻
		洗面盆	陶瓷
		座廁	陶瓷
		廁紙架	鍍鉻
		毛巾杆	金屬電鍍
		衣鈎	鍍鉻
		浴簾杆 (適用於附有浴缸之單位, 請參閱[住宅物業浴缸及淋浴設備說明表])	金屬電鍍
		毛巾圈 適用於以下單位: 第1座(1A): 32樓A及B單位之主人浴室 第1座(1B): 32樓A、B及C單位之主人浴室 第2座(2A): 38樓A、B及C單位之主人浴室 第2座(2B): 37樓及38樓A單位(複式)之主人浴室及38樓B及C單位之主人浴室	鍍鉻
	(ii) 供水系統	冷水喉	銅喉
		熱水喉	配有隔熱絕緣保護之銅喉
	(iii) 沐浴設施 (包括花灑或浴缸(如適用的話))	花灑套裝	鍍鉻
		浴缸	瓷釉壓製鋼
		浴缸水龍頭	鍍鉻
		淋浴間 (請參閱「住宅物業浴缸及淋浴設備說明表」)	強化清玻璃
	(iv) 浴缸大小 (如適用的話)	請參閱「住宅物業浴缸及淋浴設備說明表」	

備註:

- 第1座(1A及1B)不設13樓、14樓及24樓, 9樓為庇護層。
- 第2座(2A及2B)不設13樓、14樓、24樓及34樓, 9樓為庇護層。

3. Interior fittings				
Item	Description	Type		
		Type	Material	
(b) Bathroom	(i) Fittings and equipment	Basin counter top	Natural stone	
		Basin cabinet	Wooden basin cabinet with plastic laminate and metal strips	
		Mirror cabinet	Stainless steel mirror cabinet with mirror panel and glass shelves	
		Wash basin mixer	Chrome plated	
		Wash basin	Vitreous china	
		Water closet	Vitreous china	
		Toilet paper holder	Chrome plated	
		Towel bar	Metal in anodized finish	
		Robe hook	Chrome plated	
		Shower curtain rod (Applicable to units with bath tub; please refer to the "Schedule of Bath Tub and Shower Provisions of Residential Properties")	Metal in anodized finish	
		Towel ring Applicable to the following units: Master Bathroom of Units A and B on 32/F of Tower 1 (1A) Master Bathroom of Units A, B and C on 32/F of Tower 1 (1B) Master Bathroom of Units A, B and C on 38/F of Tower 2 (2A) Master Bathroom of Unit A on 37/F & 38/F (Duplex), Master Bathroom of Units B and C on 38/F of Tower 2(2B)	Chrome plated	
	(ii) Water supply system	Cold water pipes	Copper water pipes	
		Hot water pipes	Copper water pipes with thermal insulation	
	(iii) Bathing facilities (including shower or bath tub, if applicable)	Shower set	Chrome plated	
		Bath tub	Enamelled pressed steel	
		Bath mixer	Chrome plated	
		Shower compartment (Please refer to the "Schedule of Bath Tub and Shower Provisions of Residential Properties")	Clear tempered glass	
	(iv) Size of bath tub (if applicable)	Please refer to the "Schedule of Bath Tub and Shower Provisions of Residential Properties"		

Notes:

1. 13/F, 14/F and 24/F are omitted in Tower 1 (1A and 1B) and 9/F is refuge floor.
2. 13/F, 14/F, 24/F and 34/F are omitted in Tower 2 (2A and 2B) and 9/F is refuge floor.

3. 室內裝置		
細項	描述	
(c) 廚房	(i) 洗滌盆的用料	不銹鋼
	(ii) 供水系統的用料	冷水供應採用銅喉及熱水供應採用配有隔熱絕緣保護之銅喉。
	(iii) 廚櫃的用料及裝修物料	木製櫃配高光焗漆面板及膠板
	(iv) 所有其他裝置及設備的類型	鍍鉻水龍頭，有關開放式廚房內或附近的消防裝置，請參閱「住宅物業機電裝置數量說明表」。
(d) 睡房	裝置（包括嵌入式衣櫃）的類型及用料	<p>第1座(1A)：27樓A單位主人睡房設嵌入式木製衣櫃配木製層架及金屬框玻璃掩門、睡房1設嵌入式木製衣櫃配膠板飾面及鏡面掩門及木製上牆書架、睡房2設嵌入式木製衣櫃配膠板飾面、金屬及鏡面掩門及睡房3設木製上牆書架配木製層板連金屬及27樓C單位主人睡房設嵌入式木製衣櫃配木製層架及金屬框玻璃掩門</p> <p>第2座(2A)：27樓F單位主人睡房設嵌入式木製衣櫃配木製層架及金屬框木皮飾面趟門</p> <p>第2座(2B)：37樓及38樓A單位（複式）主人睡房設嵌入式木製衣櫃配鏡面、金屬、玻璃及木製層架及人造皮掩門、睡房1設嵌入式木製衣櫃配木製層架及膠板飾面及高光油漆掩門及睡房2設嵌入式木製衣櫃配膠板飾面、玻璃、皮及金屬框鏡面掩門及掛牆木製書架</p>
(e) 電話	接駁點的位置及數目	請參閱「住宅物業機電裝置數量說明表」
(f) 天線	接駁點的位置及數目	請參閱「住宅物業機電裝置數量說明表」
(g) 電力裝置	(i) 供電附件（包括安全裝置）	所有客廳、飯廳、睡房、廚房、士多房及浴室均裝有電插蘇掣。 每個住宅單位均裝有漏電保護的總電掣箱。
	(ii) 導管是隱藏或外露	導管部份隱藏及部份外露。 除部份隱藏於混凝土內之導管外，其他部份的導管均為外露。外露的導管可能被假天花、假陣、貯存櫃、覆面、非混凝土間牆，指定之管道槽或其他物料遮蓋或掩藏。
	(iii) 電插座及空調機接駁點的位置及數目	有關電插座及空調機接駁點之位置及數目，請參閱「住宅物業機電裝置數量說明表」。
(h) 氣體供應	類型及系統	<p>煤氣喉接駁煤氣煮食爐及煤氣熱水爐</p> <p>適用於以下單位：</p> <p>第1座(1A)：5樓至8樓、10樓至12樓、15樓至23樓及25樓至31樓A、B及D單位及32樓A及B單位</p> <p>第1座(1B)：5樓至8樓、10樓至12樓、15樓至23樓及25樓至32樓A、B及C單位</p> <p>第2座(2A)：5樓至8樓、10樓至12樓、15樓至23樓、25樓至33樓及35樓至37樓A、B、C、D及F單位及38樓A、B及C單位</p> <p>第2座(2B)：5樓至8樓、10樓至12樓、15樓至23樓、25樓至33樓及35樓至36樓A單位、5樓至8樓、10樓至12樓、15樓至23樓、25樓至33樓及35樓至37樓B單位、10樓至12樓、15樓至23樓、25樓至33樓及35樓至37樓C單位、6樓至8樓、10樓至12樓、15樓至23樓、25樓至33樓及35樓至37樓E單位、37樓及38樓A單位（複式）及38樓B及C單位</p> <p>除上述外，其他住宅物業不提供氣體供應。</p>
	位置	有關煤氣煮食爐及煤氣熱水爐位置，請參閱「設備說明表」。
(i) 洗衣機接駁點	設計	設有洗衣機來水接駁喉位（直徑為15毫米）及去水接駁喉位（直徑為40毫米）
	位置	請參閱「住宅物業機電裝置數量說明表」
(j) 供水	(i) 水管的用料	冷熱水供水系統採用銅喉管，沖水供水系統採用膠喉管。
	(ii) 水管是隱藏或外露	除部份隱藏於混凝土內之水管外，其他部份的水管均為外露。外露的水管可能被假天花、假陣、貯存櫃、覆面、非混凝土間牆，指定之管道槽或其他物料遮蓋或掩藏。
	(iii) 有否熱水供應	有熱水供應

備註：

- 第1座（1A及1B）不設13樓、14樓及24樓，9樓為庇護層。
- 第2座（2A及2B）不設13樓、14樓、24樓及34樓，9樓為庇護層。

3. Interior fittings		
Item	Description	
(c) Kitchen	(i) Material of sink unit	Stainless steel
	(ii) Material of water supply system	Copper water pipes are used for cold water supply and copper water pipes with thermal insulation are used for hot water supply.
	(iii) Material and finishes of kitchen cabinet	Wooden cabinet with high glossy lacquer panel and plastic laminate
	(iv) Type of all other fittings and equipment	Chrome plated mixer; For fire service installations and equipment fitted in or near open kitchen, please refer to “Schedule of Mechanical and Electrical Provisions of Residential Properties”.
(d) Bedroom	Type and material of fittings (including built-in wardrobe)	<p>Built-in wooden wardrobe with wooden shelf and metal framed glass swing door in master bedroom, built-in wooden wardrobe with plastic laminate and mirror swing door and wall mounted wooden book shelf in bedroom 1, built-in wooden wardrobe with plastic laminate, metal and mirror panel swing door in bedroom 2 and wall mounted wooden book shelf with wooden panel and metal in bedroom 3 of Unit A on 27/F of Tower 1 (1A) and built-in wooden wardrobe with wooden shelf and metal framed glass swing door in master bedroom of Unit C on 27/F of Tower 1 (1A)</p> <p>Built-in wooden wardrobe with wooden shelf and metal framed wood veneered sliding door in master bedroom of Unit F on 27/F of Tower 2 (2A)</p> <p>Built-in wooden wardrobe with wooden shelf, mirror panel, metal, glass and artificial leather swing door in master bedroom, built-in wooden wardrobe with wooden shelf and plastic laminate and high-gloss paint swing door in bedroom 1 and built-in wooden wardrobe with plastic laminate, glass, leather and metal framed mirror swing door and wall-mount wooden book shelf in bedroom 2 of Unit A on 37/F & 38/F (Duplex) of Tower 2 (2B)</p>
(e) Telephone	Location and number of connection points	Please refer to the “Schedule of Mechanical & Electrical Provisions of Residential Properties”
(f) Aerials	Location and number of connection points	Please refer to the “Schedule of Mechanical & Electrical Provisions of Residential Properties”
(g) Electrical installations	(i) Electrical fittings (including safety devices)	<p>Socket outlets are provided in all Living Rooms, Dining Rooms, Bedrooms, Kitchens, Stores and Bathrooms.</p> <p>Miniature circuit breakers board complete with residual current protection is provided for each residential unit.</p>
	(ii) Whether conduits are concealed or exposed	<p>Conduits are concealed in part and exposed in part.</p> <p>Other than those parts of the conduits concealed within concrete, the rest of them are exposed. Exposed conduits may be covered or hidden by false ceiling, bulkheads, cabinets, claddings, non-concrete partition walls, designated pipe ducts or other materials.</p>
	(iii) Location and number of power points and air-conditioner points	For the location and the number of power points and air-conditioner connection points, please refer to the “Schedule of Mechanical & Electrical Provisions of Residential Properties”.
(h) Gas supply	Type and system	<p>Gas supply pipe is provided and connected to gas hob and gas water heater</p> <p>Applicable to the following units:</p> <p>Units A, B and D on 5/F-8/F, 10/F-12/F, 15/F-23/F & 25/F-31/F and Units A and B on 32/F of Tower 1 (1A)</p> <p>Units A, B and C on 5/F-8/F, 10/F-12/F, 15/F-23/F & 25/F-32/F of Tower 1 (1B)</p> <p>Units A, B, C, D and F on 5/F-8/F, 10/F-12/F, 15/F-23/F, 25/F-33/F & 35/F-37/F and Units A, B and C on 38/F of Tower 2 (2A)</p> <p>Unit A on 5/F-8/F, 10/F-12/F, 15/F-23/F, 25/F-33/F & 35/F-36/F, Unit B on 5/F-8/F, 10/F-12/F, 15/F-23/F, 25/F-33/F & 35/F-37/F, Unit C on 10/F-12/F, 15/F-23/F, 25/F-33/F & 35/F-37/F, Unit E on 6/F-8/F, 10/F-12/F, 15/F-23/F, 25/F-33/F & 35/F-37/F, Unit A on 37/F & 38/F (Duplex) and Units B and C on 38/F of Tower 2 (2B)</p> <p>No gas supply is provided for the residential properties other than the above.</p>
	Location	For the location of gas hob and gas water heater, please refer to the “Appliances Schedule”.
(i) Washing machine connection point	Design	Water inlet connection point (15mm in diameter) and water outlet connection point (40mm in diameter) are provided for washing machine
	Location	Please refer to the “Schedule of Mechanical & Electrical Provisions of Residential Properties”
(j) Water supply	(i) Material of water pipes	Copper pipes for cold and hot water supply system. UPVC pipes for flushing water supply system.
	(ii) Whether water pipes are concealed or exposed	Other than those parts of the water pipes concealed within concrete, the rest of them are exposed. The exposed water pipes may be covered or hidden by false ceilings, bulkheads, cabinets, claddings, non-concrete partition walls, designated pipe ducts or other materials.
	(iii) Whether hot water is available	Hot water is available

Notes:

- 13/F, 14/F and 24/F are omitted in Tower 1 (1A and 1B) and 9/F is refuge floor.
- 13/F, 14/F, 24/F and 34/F are omitted in Tower 2 (2A and 2B) and 9/F is refuge floor.

4. 雜項											
細項	描述										
(a) 升降機	(i) 品牌名稱及產品型號	(ii) 升降機的數目及到達的樓層									
	日立 (產品型號: MCA)	住宅大樓設有10部升降機									
		<table border="1"> <thead> <tr> <th>座</th> <th>升降機號碼</th> <th>到達的樓層</th> </tr> </thead> <tbody> <tr> <td>第1座(1A及1B)</td> <td>1、2、3、4及5</td> <td>平台層、5樓至8樓、10樓至12樓、15樓至23樓及25樓至32樓</td> </tr> <tr> <td>第2座(2A及2B)</td> <td>6、7、8、9及10</td> <td>平台層、5樓至8樓、10樓至12樓、15樓至23樓、25樓至33樓及35樓至38樓</td> </tr> </tbody> </table>	座	升降機號碼	到達的樓層	第1座(1A及1B)	1、2、3、4及5	平台層、5樓至8樓、10樓至12樓、15樓至23樓及25樓至32樓	第2座(2A及2B)	6、7、8、9及10	平台層、5樓至8樓、10樓至12樓、15樓至23樓、25樓至33樓及35樓至38樓
		座	升降機號碼	到達的樓層							
第1座(1A及1B)	1、2、3、4及5	平台層、5樓至8樓、10樓至12樓、15樓至23樓及25樓至32樓									
第2座(2A及2B)	6、7、8、9及10	平台層、5樓至8樓、10樓至12樓、15樓至23樓、25樓至33樓及35樓至38樓									
日立 (產品型號: LCA)	平台及停車場設有5部升降機										
		<table border="1"> <thead> <tr> <th>升降機號碼</th> <th>到達的樓層</th> </tr> </thead> <tbody> <tr> <td>11及12</td> <td>2樓至3樓及平台層</td> </tr> <tr> <td>13及14</td> <td>3樓及平台層</td> </tr> <tr> <td>15</td> <td>2樓至3樓</td> </tr> </tbody> </table>	升降機號碼	到達的樓層	11及12	2樓至3樓及平台層	13及14	3樓及平台層	15	2樓至3樓	
升降機號碼	到達的樓層										
11及12	2樓至3樓及平台層										
13及14	3樓及平台層										
15	2樓至3樓										
(b) 信箱	用料	不銹鋼									
(c) 垃圾收集	(i) 垃圾收集的方法	由清潔工人收集垃圾									
	(ii) 垃圾房的位置	垃圾及物料回收室設於每層住宅樓層，垃圾及物料回收房設於3樓									

備註：

- 第1座(1A及1B)不設13樓、14樓及24樓，9樓為庇護層。
- 第2座(2A及2B)不設13樓、14樓、24樓及34樓，9樓為庇護層。

4. Miscellaneous											
Item	Description										
(a) Lifts	(i) Brand name and model number	(ii) Number of Lifts and floors served by them									
	HITACHI (model number: MCA)	10 lifts are provided for Towers									
		<table border="1"> <thead> <tr> <th>Tower</th> <th>Lift no.</th> <th>Floor served</th> </tr> </thead> <tbody> <tr> <td>Tower 1 (1A and 1B)</td> <td>1, 2, 3, 4 and 5</td> <td>Podium Floor, 5/F to 8/F, 10/F-12/F, 15/F-23/F and 25/F-32/F</td> </tr> <tr> <td>Tower 2 (2A and 2B)</td> <td>6, 7, 8, 9 and 10</td> <td>Podium Floor, 5/F-8/F, 10/F-12/F, 15/F-23/F, 25/F-33/F and 35/F-38/F</td> </tr> </tbody> </table>	Tower	Lift no.	Floor served	Tower 1 (1A and 1B)	1, 2, 3, 4 and 5	Podium Floor, 5/F to 8/F, 10/F-12/F, 15/F-23/F and 25/F-32/F	Tower 2 (2A and 2B)	6, 7, 8, 9 and 10	Podium Floor, 5/F-8/F, 10/F-12/F, 15/F-23/F, 25/F-33/F and 35/F-38/F
		Tower	Lift no.	Floor served							
Tower 1 (1A and 1B)	1, 2, 3, 4 and 5	Podium Floor, 5/F to 8/F, 10/F-12/F, 15/F-23/F and 25/F-32/F									
Tower 2 (2A and 2B)	6, 7, 8, 9 and 10	Podium Floor, 5/F-8/F, 10/F-12/F, 15/F-23/F, 25/F-33/F and 35/F-38/F									
HITACHI (model number: LCA)	5 lifts are provided for podium and carpark										
	<table border="1"> <thead> <tr> <th>Lift no.</th> <th>Floor served</th> </tr> </thead> <tbody> <tr> <td>11 and 12</td> <td>2/F-3/F and Podium Floor</td> </tr> <tr> <td>13 and 14</td> <td>3/F and Podium Floor</td> </tr> <tr> <td>15</td> <td>2/F-3/F</td> </tr> </tbody> </table>	Lift no.	Floor served	11 and 12	2/F-3/F and Podium Floor	13 and 14	3/F and Podium Floor	15	2/F-3/F		
Lift no.	Floor served										
11 and 12	2/F-3/F and Podium Floor										
13 and 14	3/F and Podium Floor										
15	2/F-3/F										
(b) Letter box	Material	Stainless steel									
(c) Refuse collection	(i) Means of refuse collection	Refuse will be collected by cleaner									
	(ii) Location of refuse room	Refuse storage and material recovery room is provided at each residential floor. Refuse storage and material recovery chamber is provided at 3/F									

Notes:

- 13/F, 14/F and 24/F are omitted in Tower 1 (1A and 1B) and 9/F is refuge floor.
- 13/F, 14/F, 24/F and 34/F are omitted in Tower 2 (2A and 2B) and 9/F is refuge floor.

4. 雜項			
細項	描述		
		(i) 位置	(ii) 就住宅單位而言是獨立抑或公用的錶
(d) 水錶、電錶及氣體錶	水錶	每層住宅樓層之水錶櫃	獨立錶
	電錶	每層住宅樓層之電錶櫃	獨立錶
	氣體錶	氣體錶安裝於個別單位廚房內 適用於以下單位： 第1座(1A)：5樓至8樓、10樓至12樓、15樓至23樓及25樓至31樓A、B及D單位及32樓A及B單位 第1座(1B)：5樓至8樓、10樓至12樓、15樓至23樓及25樓至32樓A、B及C單位 第2座(2A)：5樓至8樓、10樓至12樓、15樓至23樓、25樓至33樓、35樓至37樓A、B、C、D及F單位及38樓A、B及C單位 第2座(2B)：5樓至8樓、10樓至12樓、15樓至23樓、25樓至33樓及35樓至36樓A單位、5樓至8樓、10樓至12樓、15樓至23樓、25樓至33樓及35樓至37樓B單位、10樓至12樓、15樓至23樓、25樓至33樓及35樓至37樓C單位、6樓至8樓、10樓至12樓、15樓至23樓、25樓至33樓及35樓至37樓E單位、37樓及38樓A單位（複式）及38樓B及C單位	獨立錶

5. 保安設施	
細項	描述
保安系統及設備（包括嵌入式的裝備的細節及其位置）	大堂出入口、升降機大堂、停車場及各升降機內均設有閉路電視系統並連接管理處及保安台。每戶住宅單位均備有視象對講機連警報按鈕。智能咭識別系統設於住宅大樓大堂出入口、康樂設施層及住戶信箱。

6. 設備	
細項	描述
品牌名稱和產品型號	請參考「設備說明表」

有關於期數在上述列表所指明之第4(a)及第6細項，賣方承諾如期數中沒有安裝指明的品牌名稱或產品型號的升降機或設備，便會安裝品質相若的升降機或設備。

備註：

- 第1座（1A及1B）不設13樓、14樓及24樓，9樓為庇護層。
- 第2座（2A及2B）不設13樓、14樓、24樓及34樓，9樓為庇護層。

4. Miscellaneous			
Item	Description		
		(i) Location	(ii) Whether they are separate or communal meters for residential properties
(d) Water meter, electricity meter and gas meter	Water meter	In water meter cabinet on each residential floor	Separate meter
	Electricity meter	In electric meter cabinet on each residential floor	Separate meter
	Gas meter	Gas meter is provided in kitchen of individual residential unit Applicable to the following units: Units A, B and D on 5/F-8/F, 10/F-12/F, 15/F-23/F & 25/F-31/F and Units A and B on 32/F of Tower 1 (1A) Units A, B and C on 5/F-8/F, 10/F-12/F, 15/F-23/F & 25/F-32/F of Tower 1 (1B) Units A, B, C, D and F on 5/F-8/F, 10/F-12/F, 15/F-23/F, 25/F-33/F & 35/F-37/F and Units A, B and C on 38/F of Tower 2 (2A) Unit A on 5/F-8/F, 10/F-12/F, 15/F-23/F, 25/F-33/F & 35/F-36/F, Unit B on 5/F-8/F, 10/F-12/F, 15/F-23/F, 25/F-33/F & 35/F-37/F, Unit C on 10/F-12/F, 15/F-23/F, 25/F-33/F & 35/F-37/F, Unit E on 6/F-8/F, 10/F-12/F, 15/F-23/F, 25/F-33/F & 35/F-37/F, Unit A on 37/F & 38/F (Duplex) and Units B and C on 38/F of Tower 2 (2B)	Separate meter

5. Security Facilities	
Item	Description
Security system and equipment (including details of built-in provisions and their locations)	CCTV system connected to the management office and security counter is installed at the main lobby entrance, lift lobbies, car park and each lift. Video doorphone with panic alarm button is provided for each residential unit. Proximity card access system is provided at the main lobby entrance of residential tower, recreational facilities floor and resident letter box.

6. Appliances	
Item	Description
Brand name and model number	Please refer to "Appliances Schedule"

In relation to items 4(a) and 6 in the Phase specified in the above table, the vendor undertakes that if lifts or appliances of the specified brand name or model number are not installed in the Phase, lifts or appliances of comparable quality will be installed.

Notes:

- 13/F, 14/F and 24/F are omitted in Tower 1 (1A and 1B) and 9/F is refuge floor.
- 13/F, 14/F, 24/F and 34/F are omitted in Tower 2 (2A and 2B) and 9/F is refuge floor.

住宅物業浴缸及淋浴設備說明表
Schedule of Bathtub and Shower Provisions of Residential Properties

第1座 (1A) Tower 1 (1A)													
位置 Location	樓層 Floor	5樓 5/F					6樓至8樓、10樓至12樓、 15樓至23樓及25樓至31樓 6/F-8/F, 10/F-12/F, 15/F-23/F & 25/F-31/F					32樓 32/F	
		單位 Unit	A	B	C	D	E	A	B	C	D	E	A
主人浴室 Master Bathroom	浴缸 Bath tub (1600 (長)(L) x 700 (闊)(W) x 390 (高)(H))	Y	Y	-	Y	-	Y	Y	-	Y	-	-	Y
	浴缸 Bath tub (1700 (長)(L) x 750 (闊)(W) x 390 (高)(H))	-	-	-	-	-	-	-	-	-	-	Y	-
	淋浴間 Shower Compartment	Y	-	-	-	-	Y	-	-	-	-	Y	-
浴室 Bathroom	浴缸 Bath tub (1500 (長)(L) x 700 (闊)(W) x 390 (高)(H))	-	-	Y	-	Y	-	-	Y	-	Y	-	Y
	浴缸 Bath tub (1600 (長)(L) x 700 (闊)(W) x 390 (高)(H))	Y	Y	-	Y	-	Y	Y	-	Y	-	-	-
浴室 1 Bathroom 1	淋浴間 Shower Compartment	-	-	-	-	-	-	-	-	-	-	Y	-
浴室 2 Bathroom 2	浴缸 Bath tub (1600 (長)(L) x 700 (闊)(W) x 390 (高)(H))	-	-	-	-	-	-	-	-	-	-	Y	-

備註:

1. 上表之尺寸為以毫米標示之浴缸尺寸。
2. "Y" 表示此設備於該住宅物業內提供及 / 或安裝。
3. 上表 "-" 代表不適用。
4. 第1座 (1A及1B) 不設13樓、14樓及24樓，9樓為庇護層。
5. 第2座 (2A及2B) 不設13樓、14樓、24樓及34樓，9樓為庇護層。

Notes:

1. The dimensions in the above table are all bath tub dimensions in millimetre.
2. "Y" means such appliance(s) is / are provided and / or installed in the residential property.
3. The symbol "-" as shown in the above table denotes "Not applicable".
4. 13/F, 14/F and 24/F are omitted in Tower 1 (1A and 1B) and 9/F is refuge floor.
5. 13/F, 14/F, 24/F and 34/F are omitted in Tower 2 (2A and 2B) and 9/F is refuge floor.

住宅物業浴缸及淋浴設備說明表
Schedule of Bathtub and Shower Provisions of Residential Properties

第1座 (1B) Tower 1 (1B)																
位置 Location	樓層 Floor	5樓 5/F						6樓至8樓、10樓至12樓、 15樓至23樓及25樓至31樓 6/F-8/F, 10/F-12/F, 15/F-23/F & 25/F-31/F						32樓 32/F		
		單位 Unit	A	B	C	D	E	F	A	B	C	D	E	F	A	B
主人浴室 Master Bathroom	浴缸 Bath tub (1500 (長)(L) x 700 (闊)(W) x 390 (高)(H))	-	-	Y	-	-	-	-	-	Y	-	-	-	-	-	-
	浴缸 Bath tub (1600 (長)(L) x 700 (闊)(W) x 390 (高)(H))	Y	Y	-	-	-	-	Y	Y	-	-	-	-	-	-	-
	浴缸 Bath tub (1700 (長)(L) x 750 (闊)(W) x 390 (高)(H))	-	-	-	-	-	-	-	-	-	-	-	-	Y	Y	Y
	淋浴間 Shower Compartment	Y	-	-	-	-	-	Y	-	-	-	-	-	Y	-	-
浴室 Bathroom	浴缸 Bath tub (1500 (長)(L) x 700 (闊)(W) x 390 (高)(H))	-	-	Y	Y	Y	Y	-	-	Y	Y	Y	Y	-	Y	-
	浴缸 Bath tub (1600 (長)(L) x 700 (闊)(W) x 390 (高)(H))	-	Y	-	-	-	-	-	Y	-	-	-	-	-	-	Y
浴室 1 Bathroom 1	淋浴間 Shower Compartment	Y	-	-	-	-	-	Y	-	-	-	-	-	Y	-	-
浴室 2 Bathroom 2	浴缸 Bath tub (1600 (長)(L) x 700 (闊)(W) x 390 (高)(H))	Y	-	-	-	-	-	Y	-	-	-	-	-	-	-	-
	淋浴間 Shower Compartment	-	-	-	-	-	-	-	-	-	-	-	-	Y	-	-
浴室 3 Bathroom 3	浴缸 Bath tub (1600 (長)(L) x 700 (闊)(W) x 390 (高)(H))	-	-	-	-	-	-	-	-	-	-	-	-	Y	-	-

備註:

1. 上表之尺寸為以毫米標示之浴缸尺寸。
2. "Y" 表示此設備於該住宅物業內提供及 / 或安裝。
3. 上表 "-" 代表不適用。
4. 第1座 (1A及1B) 不設13樓、14樓及24樓，9樓為庇護層。
5. 第2座 (2A及2B) 不設13樓、14樓、24樓及34樓，9樓為庇護層。

Notes:

1. The dimensions in the above table are all bath tub dimensions in millimetre.
2. "Y" means such appliance(s) is / are provided and / or installed in the residential property.
3. The symbol "-" as shown in the above table denotes "Not applicable".
4. 13/F, 14/F and 24/F are omitted in Tower 1 (1A and 1B) and 9/F is refuge floor.
5. 13/F, 14/F, 24/F and 34/F are omitted in Tower 2 (2A and 2B) and 9/F is refuge floor.

住宅物業浴缸及淋浴設備說明表
Schedule of Bathtub and Shower Provisions of Residential Properties

第2座 (2A) Tower 2 (2A)																
位置 Location	樓層 Floor	5樓 5/F						6樓至8樓、10樓至12樓、15樓至23樓、 25樓至33樓及35樓至37樓 6/F-8/F, 10/F-12/F, 15/F-23/F, 25/F-33/F & 35/F-37/F						38樓 38/F		
		單位 Unit	A	B	C	D	E	F	A	B	C	D	E	F	A	B
主人浴室 Master Bathroom	浴缸 Bath tub (1600 (長)(L) x 700 (闊)(W) x 390 (高)(H))	Y	Y	Y	Y	-	-	Y	Y	Y	Y	-	-	-	-	-
	浴缸 Bath tub (1700 (長)(L) x 750 (闊)(W) x 390 (高)(H))	-	-	-	-	-	-	-	-	-	-	-	-	Y	Y	Y
	淋浴間 Shower Compartment	-	-	-	-	-	-	-	-	-	-	-	-	-	Y	-
浴室 Bathroom	浴缸 Bath tub (1500 (長)(L) x 700 (闊)(W) x 390 (高)(H))	-	-	-	-	Y	Y	-	-	-	-	Y	Y	-	-	Y
	浴缸 Bath tub (1600 (長)(L) x 700 (闊)(W) x 390 (高)(H))	Y	Y	Y	Y	-	-	Y	Y	Y	Y	-	-	-	-	-
浴室 1 Bathroom 1	淋浴間 Shower Compartment	-	-	-	-	-	-	-	-	-	-	-	-	Y	Y	-
浴室 2 Bathroom 2	浴缸 Bath tub (1500 (長)(L) x 700 (闊)(W) x 390 (高)(H))	-	-	-	-	-	-	-	-	-	-	-	-	Y	-	-
	浴缸 Bath tub (1600 (長)(L) x 700 (闊)(W) x 390 (高)(H))	-	-	-	-	-	-	-	-	-	-	-	-	-	Y	-

備註:

- 上表之尺寸為以毫米標示之浴缸尺寸。
- "Y" 表示此設備於該住宅物業內提供及 / 或安裝。
- 上表 "-" 代表不適用。
- 第1座 (1A及1B) 不設13樓、14樓及24樓，9樓為庇護層。
- 第2座 (2A及2B) 不設13樓、14樓、24樓及34樓，9樓為庇護層。

Notes:

- The dimensions in the above table are all bath tub dimensions in millimetre.
- "Y" means such appliance(s) is / are provided and / or installed in the residential property.
- The symbol "-" as shown in the above table denotes "Not applicable".
- 13/F, 14/F and 24/F are omitted in Tower 1 (1A and 1B) and 9/F is refuge floor.
- 13/F, 14/F, 24/F and 34/F are omitted in Tower 2 (2A and 2B) and 9/F is refuge floor.

住宅物業浴缸及淋浴設備說明表
Schedule of Bathtub and Shower Provisions of Residential Properties

第2座 (2B) Tower 2 (2B)																													
位置 Location	樓層 Floor	5樓 5/F				6樓至8樓 6/F to 8/F							10樓至12樓、15樓至23樓、 25樓33樓及35樓至36樓 10/F-12/F, 15/F-23/F, 25/F-33/F & 35/F-36/F						37樓 37/F					37樓及38樓 (複式) 37/F & 38/F (Duplex)			38樓 38/F		
		單位 Unit	A	B	C	G	A	B	C	D	E	F	G	A	B	C	E	F	G	B	C	E	F	G	A	B	C		
主人浴室 Master Bathroom	浴缸 Bath tub (1500 (長)(L) x 700 (闊)(W) x 390 (高)(H))	Y	-	Y	-	Y	-	-	-	-	-	-	Y	-	-	-	-	-	-	-	-	-	-	-	-	-	-		
	浴缸 Bath tub (1600 (長)(L) x 700 (闊)(W) x 390 (高)(H))	-	-	-	-	-	-	-	-	-	-	-	-	-	Y	-	-	-	-	Y	-	-	-	-	Y	-	Y		
	浴缸 Bath tub (1700 (長)(L) x 750 (闊)(W) x 390 (高)(H))	-	-	-	-	-	-	-	-	-	-	-	-	-	-	-	-	-	-	-	-	-	-	-	-	Y	-		
	淋浴間 Shower Compartment	-	-	-	-	-	-	-	-	-	-	-	-	-	-	-	-	-	-	-	-	-	-	-	-	Y	-		
浴室 Bathroom	浴缸 Bath tub (1500 (長)(L) x 700 (闊)(W) x 390 (高)(H))	Y	Y	-	Y	Y	Y	Y	-	Y	Y	Y	Y	Y	-	Y	Y	Y	Y	-	Y	Y	Y	-	-	Y			
	浴缸 Bath tub (1600 (長)(L) x 700 (闊)(W) x 390 (高)(H))	-	-	-	-	-	-	-	-	-	-	-	-	-	Y	-	-	-	-	Y	-	-	-	-	Y	-	-		
	淋浴間 Shower Compartment	-	-	-	-	-	-	-	Y	-	-	-	-	-	-	-	-	-	-	-	-	-	-	-	-	-	-		
浴室1 Bathroom 1	浴缸 Bath tub (1600 (長)(L) x 700 (闊)(W) x 390 (高)(H))	-	-	-	-	-	-	-	-	-	-	-	-	-	-	-	-	-	-	-	-	-	-	-	-	Y	-		
浴室2 Bathroom 2	浴缸 Bath tub (1600 (長)(L) x 700 (闊)(W) x 390 (高)(H))	-	-	-	-	-	-	-	-	-	-	-	-	-	-	-	-	-	-	-	-	-	-	-	-	Y	-		

備註:

1. 上表之尺寸為以毫米標示之浴缸尺寸。
2. "Y" 表示此設備於該住宅物業內提供及 / 或安裝。
3. 上表 "-" 代表不適用。
4. 第1座 (1A及1B) 不設13樓、14樓及24樓，9樓為庇護層。
5. 第2座 (2A及2B) 不設13樓、14樓、24樓及34樓，9樓為庇護層。

Notes:

1. The dimensions in the above table are all bath tub dimensions in millimetre.
2. "Y" means such appliance(s) is / are provided and / or installed in the residential property.
3. The symbol "-" as shown in the above table denotes "Not applicable".
4. 13/F, 14/F and 24/F are omitted in Tower 1 (1A and 1B) and 9/F is refuge floor.
5. 13/F, 14/F, 24/F and 34/F are omitted in Tower 2 (2A and 2B) and 9/F is refuge floor.

設備說明表 Appliances Schedule

設備 Appliance	品牌 Brand	型號 Model No.	第1座 (1A) Tower 1 (1A)												
			5樓 5/F					6樓至8樓、10樓至12樓、 15樓至23樓及25樓至31樓 6/F-8/F, 10/F-12/F, 15/F-23/F & 25/F-31/F					32樓 32/F		
			A	B	C	D	E	A	B	C	D	E	A	B	
雙頭氣體煮食爐 Gas hob - 2 burners	Gaggenau	VG232320HK	Y	Y	-	-	-	Y	Y	-	-	-	Y	Y	
單頭氣體煮食爐 Gas hob - 1 burner		VG231320HK	Y	Y	-	Y	-	Y	Y	-	Y	-	Y	Y	
電磁爐 Induction hob		VI232120	Y	Y	-	Y	-	Y	Y	-	Y	-	Y	Y	
		CI262115	-	-	Y	-	Y	-	-	Y	-	Y	-	-	
抽油煙機 Cooker hood		AF210162	-	-	Y	Y	Y	-	-	Y	Y	Y	-	-	
		AW240191	-	Y	-	-	-	-	Y	-	-	-	-	Y	
		AW442120	Y	-	-	-	-	Y	-	-	-	-	Y	-	
蒸焗爐 Combi-steam oven		BSP250111 / BSP251111	-	Y	Y	Y	Y	-	Y	Y	Y	Y	-	-	
蒸爐 Steamer		BSP220111 / BSP221111	Y	-	-	-	-	Y	-	-	-	-	Y	Y	
焗爐 Oven		BOP210112 / BOP211112	Y	-	-	-	-	Y	-	-	-	-	-	Y	
		EB333111	-	-	-	-	-	-	-	-	-	-	Y	-	
洗碗碟機 Dishwasher		DF480100	Y	-	-	-	-	Y	-	-	-	-	Y	-	
咖啡機 Coffee machine		CMP250112	Y	-	-	-	-	Y	-	-	-	-	Y	Y	
雪櫃 Fridge freezer		RB280304	-	-	Y	Y	Y	-	-	Y	Y	Y	-	-	
		RB472303	-	Y	-	-	-	-	Y	-	-	-	-	-	
		RY492303	Y	-	-	-	-	Y	-	-	-	-	-	-	
		Sub-zero	ICBIT-30CIID	-	-	-	-	-	-	-	-	-	-	-	Y
			ICBBI-36UFDID	-	-	-	-	-	-	-	-	-	-	Y	-
洗衣乾衣機 Washer dryer	Gaggenau	WD200140	-	Y	Y	Y	Y	-	Y	Y	Y	Y	-	Y	
洗衣機 Washer		WM260164	Y	-	-	-	-	Y	-	-	-	-	Y	-	

賣方承諾如期數中沒有安裝指明的品牌名稱或產品型號的升降機或設備，便會安裝品質相若的升降機或設備。

備註：

- "Y" 表示此設備於該住宅物業內提供及 / 或安裝。
- 上表 "-" 代表不適用。
- 第1座 (1A及1B) 不設13樓、14樓及24樓，9樓為庇護層。
- 第2座 (2A及2B) 不設13樓、14樓、24樓及34樓，9樓為庇護層。

The Vendor undertakes that if lifts or appliances of the specified brand name or model number are not installed in the Phase, lifts or appliances of comparable quality will be installed.

Notes:

- "Y" means such appliance(s) is / are provided and / or installed in the residential property.
- The symbol "-" as shown in the above table denotes "Not applicable".
- 13/F, 14/F and 24/F are omitted in Tower 1 (1A and 1B) and 9/F is refuge floor.
- 13/F, 14/F, 24/F and 34/F are omitted in Tower 2 (2A and 2B) and 9/F is refuge floor.

設備說明表 Appliances Schedule

設備 Appliance	品牌 Brand	型號 Model No.	第1座 (1A) Tower 1 (1A)													
			5樓 5/F					6樓至8樓、10樓至12樓、 15樓至23樓及25樓至31樓 6/F-8/F, 10/F-12/F, 15/F-23/F & 25/F-31/F					32樓 32/F			
			A	B	C	D	E	A	B	C	D	E	A	B		
乾衣機 Dryer	Gaggenau	WT260110	Y	-	-	-	-	-	Y	-	-	-	-	Y	-	
酒櫃 Wine cellar		RW404261	Y	-	-	-	-	-	Y	-	-	-	-	Y	-	
酒櫃 Wine cellar	名望 Vinvautz	VZ19SSUG	-	Y	-	-	-	-	-	Y	-	-	-	-	Y	
視像對講機 Video door phone	Urmet	NEXO 1708/1	Y	Y	Y	Y	Y	Y	Y	Y	Y	Y	Y	Y	Y	
分體式變頻冷暖空調機 (室內機) Split type inverter heat pump air-conditioner (Indoor unit)	樂聲牌 Panasonic	CS-Z42TKEW	-	Y	Y	-	-	-	-	Y	Y	-	Y	-	-	
		CS-Z25TKEW	-	Y	Y	-	-	-	-	Y	Y	-	Y	-	-	
CS-YE18UKA1		-	-	Y	-	-	-	-	-	-	Y	-	Y	-	-	
分體式變頻冷暖空調機 (室外機) Split type Inverter heat pump air-conditioner (Outdoor unit)		CU-4E23PBE	-	Y	Y	-	-	-	-	-	Y	Y	-	Y	-	-
		CU-YE18UKA1	-	-	Y	-	-	-	-	-	-	Y	-	Y	-	-
可變冷媒流量空調機 (室內機) Variable refrigerant volume air-conditioner (Indoor unit)		S-73MK2E5A	-	-	-	-	-	-	-	-	-	-	-	-	Y	Y
		S-56MK2E5A	Y	-	-	-	Y	Y	Y	Y	-	-	-	-	-	Y
		S-45MK2E5A	-	-	-	Y	Y	-	-	-	-	Y	-	Y	-	-
		S-28MK2E5A	Y	-	-	Y	Y	Y	Y	Y	-	-	Y	-	-	Y
可變冷媒流量風管式空調機 (室內機) Variable refrigerant volume duct type air-conditioner (Indoor unit)		S-22MK2E5A	Y	-	-	-	-	-	Y	-	-	-	-	-	Y	Y
		S-56MF2E5A	-	-	-	-	-	-	-	-	-	-	-	-	Y	-
		S-45MF2E5A	-	-	-	-	-	-	-	-	-	-	-	-	-	Y
		S-28MF2E5A	Y	-	-	-	-	-	Y	-	-	-	-	-	-	

賣方承諾如期數中沒有安裝指明的品牌名稱或產品型號的升降機或設備，便會安裝品質相若的升降機或設備。

備註：

- "Y" 表示此設備於該住宅物業內提供及 / 或安裝。
- 上表 "-" 代表不適用。
- 第1座 (1A及1B) 不設13樓、14樓及24樓，9樓為庇護層。
- 第2座 (2A及2B) 不設13樓、14樓、24樓及34樓，9樓為庇護層。

The Vendor undertakes that if lifts or appliances of the specified brand name or model number are not installed in the Phase, lifts or appliances of comparable quality will be installed.

Notes:

- "Y" means such appliance(s) is / are provided and / or installed in the residential property.
- The symbol "-" as shown in the above table denotes "Not applicable".
- 13/F, 14/F and 24/F are omitted in Tower 1 (1A and 1B) and 9/F is refuge floor.
- 13/F, 14/F, 24/F and 34/F are omitted in Tower 2 (2A and 2B) and 9/F is refuge floor.

設備說明表 Appliances Schedule

設備 Appliance	品牌 Brand	型號 Model No.	第1座 (1A) Tower 1 (1A)												
			5樓 5/F					6樓至8樓、10樓至12樓、 15樓至23樓及25樓至31樓 6/F-8/F, 10/F-12/F, 15/F-23/F & 25/F-31/F					32樓 32/F		
			A	B	C	D	E	A	B	C	D	E	A	B	
可變冷媒流量空調機 (室外機) Variable refrigerant volume air-conditioner (Outdoor unit)	樂聲牌 Panasonic	U-8LE1H7	-	-	-	Y	-	-	-	-	Y	-	Y	Y	
		U-5LE2H7	-	-	-	-	Y	-	-	-	-	-	Y	Y	
		U-4LE2H7	Y	-	-	-	-	Y	-	-	-	-	-	-	-
		U-4LE2H4	Y	-	-	-	-	Y	-	-	-	-	-	-	-
抽氣扇 Exhaust fan	奧斯博格 Ostberg	LPK 125 B1-c	Y	Y	-	Y	-	Y	Y	-	Y	-	Y	Y	
		DFE133-20 ErP	-	-	-	-	-	-	-	-	-	-	-	Y	-
	樂聲牌 Panasonic	FV-04NU1H	-	-	-	-	Y	-	-	-	-	Y	-	Y	
換氣暖風機 Thermo ventilator	樂聲牌 Panasonic	FV-40BE3H2	Y	Y	Y	Y	Y	Y	Y	Y	Y	Y	Y	Y	
電熱水爐 Electric water heater	斯寶亞創 Stiebel Eltron	DHB-E 27 LCD	Y	Y	Y	Y	Y	Y	Y	Y	Y	Y	Y	Y	
煤氣熱水爐 Gas water heater	TGC	TNJW221	-	-	-	-	-	-	-	-	-	-	-	Y	-
		161TFQL	Y	Y	-	Y	-	Y	Y	-	Y	-	-	-	Y

賣方承諾如期數中沒有安裝指明的品牌名稱或產品型號的升降機或設備，便會安裝品質相若的升降機或設備。

備註：

- "Y" 表示此設備於該住宅物業內提供及 / 或安裝。
- 上表 "-" 代表不適用。
- 第1座 (1A及1B) 不設13樓、14樓及24樓，9樓為庇護層。
- 第2座 (2A及2B) 不設13樓、14樓、24樓及34樓，9樓為庇護層。

The Vendor undertakes that if lifts or appliances of the specified brand name or model number are not installed in the Phase, lifts or appliances of comparable quality will be installed.

Notes:

- "Y" means such appliance(s) is / are provided and / or installed in the residential property.
- The symbol "-" as shown in the above table denotes "Not applicable".
- 13/F, 14/F and 24/F are omitted in Tower 1 (1A and 1B) and 9/F is refuge floor.
- 13/F, 14/F, 24/F and 34/F are omitted in Tower 2 (2A and 2B) and 9/F is refuge floor.

設備說明表 Appliances Schedule

設備 Appliance	品牌 Brand	型號 Model No.	第1座 (1B) Tower 1 (1B)															
			5樓 5/F						6樓至8樓、10樓至12樓、 15樓至23樓及25樓至31樓 6/F-8/F, 10/F-12/F, 15/F-23/F & 25/F-31/F						32樓 32/F			
			A	B	C	D	E	F	A	B	C	D	E	F	A	B	C	
雙頭氣體煮食爐 Gas hob - 2 burners	Gaggenau	VG232320HK	Y	Y	-	-	-	-	Y	Y	-	-	-	-	Y	Y	Y	
單頭氣體煮食爐 Gas hob - 1 burner		VG231320HK	Y	Y	Y	-	-	-	Y	Y	Y	-	-	-	Y	Y	Y	
電磁爐 Induction hob		VI232120	Y	Y	Y	-	-	-	Y	Y	Y	-	-	-	Y	Y	Y	
		CI262115	-	-	-	Y	Y	Y	-	-	-	Y	Y	Y	-	-	-	
抽油煙機 Cooker hood		AF210162	-	-	Y	Y	Y	Y	-	-	Y	Y	Y	Y	-	-	-	
		AW240191	-	Y	-	-	-	-	-	Y	-	-	-	-	-	Y	Y	
		AW442120	Y	-	-	-	-	-	Y	-	-	-	-	-	Y	-	-	
蒸焗爐 Combi-steam oven		BSP250111 / BSP251111	-	Y	Y	Y	Y	Y	-	Y	Y	Y	Y	Y	-	-	Y	
蒸爐 Steamer		BSP220111 / BSP221111	Y	-	-	-	-	-	Y	-	-	-	-	-	Y	Y	-	
焗爐 Oven		BOP210112 / BOP211112	Y	-	-	-	-	-	Y	-	-	-	-	-	-	Y	-	
		EB333111	-	-	-	-	-	-	-	-	-	-	-	-	Y	-	-	
洗碗碟機 Dishwasher		DF480100	Y	-	-	-	-	-	Y	-	-	-	-	-	Y	-	-	
咖啡機 Coffee machine		CMP250112	Y	-	-	-	-	-	Y	-	-	-	-	-	Y	Y	-	
雪櫃 Fridge freezer		RB280304	-	-	Y	Y	Y	Y	-	-	Y	Y	Y	Y	-	-	-	
		RB472303	-	Y	-	-	-	-	-	Y	-	-	-	-	-	-	-	
		RY492303	Y	-	-	-	-	-	Y	-	-	-	-	-	-	-	-	
		Sub-zero	ICBIT-30CIID	-	-	-	-	-	-	-	-	-	-	-	-	-	Y	Y
			ICBBI-36UFDID	-	-	-	-	-	-	-	-	-	-	-	-	Y	-	-
洗衣乾衣機 Washer dryer		WD200140	-	Y	Y	Y	Y	Y	-	Y	Y	Y	Y	Y	-	Y	-	
		WD220140	-	-	-	-	-	-	-	-	-	-	-	-	-	-	Y	
洗衣機 Washer	WM260164	Y	-	-	-	-	-	Y	-	-	-	-	-	Y	-	-		

賣方承諾如期數中沒有安裝指明的品牌名稱或產品型號的升降機或設備，便會安裝品質相若的升降機或設備。

備註：

- "Y" 表示此設備於該住宅物業內提供及 / 或安裝。
- 上表 "-" 代表不適用。
- 第1座 (1A及1B) 不設13樓、14樓及24樓，9樓為庇護層。
- 第2座 (2A及2B) 不設13樓、14樓、24樓及34樓，9樓為庇護層。

The Vendor undertakes that if lifts or appliances of the specified brand name or model number are not installed in the Phase, lifts or appliances of comparable quality will be installed.

Notes:

- "Y" means such appliance(s) is / are provided and / or installed in the residential property.
- The symbol "-" as shown in the above table denotes "Not applicable".
- 13/F, 14/F and 24/F are omitted in Tower 1 (1A and 1B) and 9/F is refuge floor.
- 13/F, 14/F, 24/F and 34/F are omitted in Tower 2 (2A and 2B) and 9/F is refuge floor.

設備說明表 Appliances Schedule

設備 Appliance	品牌 Brand	型號 Model No.	第1座 (1B) Tower 1 (1B)															
			5樓 5/F						6樓至8樓、10樓至12樓、 15樓至23樓及25樓至31樓 6/F-8/F, 10/F-12/F, 15/F-23/F & 25/F-31/F						32樓 32/F			
			A	B	C	D	E	F	A	B	C	D	E	F	A	B	C	
乾衣機 Dryer	Gaggenau	WT260110	Y	-	-	-	-	-	-	Y	-	-	-	-	-	Y	-	-
酒櫃 Wine cellar		RW404261	Y	-	-	-	-	-	-	Y	-	-	-	-	-	Y	-	-
酒櫃 Wine cellar	名望 Vinvautz	VZ19SSUG	-	Y	-	-	-	-	-	-	Y	-	-	-	-	-	Y	-
視像對講機 Video door phone	Urmet	NEXO 1708/1	Y	Y	Y	Y	Y	Y	Y	Y	Y	Y	Y	Y	Y	Y	Y	Y
分體式變頻冷暖空調機 (室內機) Split type inverter heat pump air-conditioner (Indoor unit)	樂聲牌 Panasonic	CS-Z50TKEW	Y	-	-	-	-	-	-	Y	-	-	-	-	-	-	-	-
		CS-Z42TKEW	-	Y	-	Y	Y	-	-	Y	Y	Y	Y	Y	Y	-	-	-
		CS-Z25TKEW	Y	Y	-	Y	Y	-	Y	Y	Y	Y	Y	Y	Y	-	-	-
		CS-YE18UKA1	-	-	-	Y	Y	-	-	-	Y	Y	Y	Y	Y	-	-	-
分體式風管式變頻冷暖空調機 (室內機) Split type duct type inverter heat pump air-conditioner (Indoor unit)		CS-Z35UD3EAW	Y	-	-	-	-	-	-	Y	-	-	-	-	-	-	-	-
分體式變頻冷暖空調機 (室外機) Split type inverter heat pump air-conditioner (Outdoor unit)		CU-5E34PBE	Y	-	-	-	-	-	-	Y	-	-	-	-	-	-	-	-
		CU-4E23PBE	-	Y	-	Y	Y	-	-	-	Y	Y	Y	Y	Y	-	-	-
		CU-2E18SBE	Y	-	-	-	-	-	-	Y	-	-	-	-	-	-	-	-
		CU-YE18UKA1	-	-	-	Y	Y	-	-	-	-	Y	Y	Y	Y	-	-	-
可變冷媒流量空調機 (室內機) Variable refrigerant volume air-conditioner (Indoor unit)		S-56MK2E5A	-	-	Y	-	-	Y	-	-	-	-	-	-	-	Y	Y	Y
	S-45MK2E5A	-	-	Y	-	-	Y	-	-	-	-	-	-	-	Y	Y	-	
	S-28MK2E5A	-	-	Y	-	-	Y	-	-	-	-	-	-	-	-	-	Y	
	S-22MK2E5A	-	-	-	-	-	-	-	-	-	-	-	-	-	Y	Y	Y	

賣方承諾如期數中沒有安裝指明的品牌名稱或產品型號的升降機或設備，便會安裝品質相若的升降機或設備。

備註：

- "Y" 表示此設備於該住宅物業內提供及 / 或安裝。
- 上表 "-" 代表不適用。
- 第1座 (1A 及 1B) 不設 13 樓、14 樓及 24 樓，9 樓為庇護層。
- 第2座 (2A 及 2B) 不設 13 樓、14 樓、24 樓及 34 樓，9 樓為庇護層。

The Vendor undertakes that if lifts or appliances of the specified brand name or model number are not installed in the Phase, lifts or appliances of comparable quality will be installed.

Notes:

- "Y" means such appliance(s) is / are provided and / or installed in the residential property.
- The symbol "-" as shown in the above table denotes "Not applicable".
- 13/F, 14/F and 24/F are omitted in Tower 1 (1A and 1B) and 9/F is refuge floor.
- 13/F, 14/F, 24/F and 34/F are omitted in Tower 2 (2A and 2B) and 9/F is refuge floor.

設備說明表 Appliances Schedule

設備 Appliance	品牌 Brand	型號 Model No.	第1座 (1B) Tower 1 (1B)															
			5樓 5/F						6樓至8樓、10樓至12樓、 15樓至23樓及25樓至31樓 6/F-8/F, 10/F-12/F, 15/F-23/F & 25/F-31/F						32樓 32/F			
			A	B	C	D	E	F	A	B	C	D	E	F	A	B	C	
可變冷媒流量風管式空調機 (室內機) Variable refrigerant volume duct type air-conditioner (Indoor unit)	樂聲牌 Panasonic	S-45MF2E5A	-	-	-	-	-	-	-	-	-	-	-	-	-	Y	Y	-
		S-28MF2E5A	-	-	-	-	-	-	-	-	-	-	-	-	-	-	-	Y
可變冷媒流量空調機 (室外機) Variable refrigerant volume air-conditioner (Outdoor unit)		U-8LE1H7	-	-	-	-	-	-	-	-	-	-	-	-	-	-	Y	-
		U-4LE2H7	-	-	-	-	-	-	-	-	-	-	-	-	-	-	Y	-
		U-6LE2H7	-	-	-	-	-	-	-	-	-	-	-	-	-	Y	-	Y
		U-5LE2H7	-	-	Y	-	-	Y	-	-	-	-	-	-	-	-	-	Y
抽氣扇 Exhaust fan	奧斯博格 Ostberg	LPK 125 B1-c	Y	Y	Y	-	-	-	Y	Y	Y	-	-	-	Y	Y	Y	
		DFE133-20 ErP	-	-	-	-	-	-	-	-	-	-	-	-	-	Y	-	-
	樂聲牌 Panasonic	FV-04NU1H	-	-	Y	-	-	-	-	-	Y	-	-	-	-	-	-	-
換氣暖風機 Thermo ventilator	樂聲牌 Panasonic	FV-40BE3H2	Y	Y	Y	Y	Y	Y	Y	Y	Y	Y	Y	Y	Y	Y	Y	
電熱水爐 Electric water heater	斯寶亞創 Stiebel Eltron	DHB-E 27 LCD	Y	Y	-	Y	Y	Y	Y	Y	-	Y	Y	Y	Y	Y	Y	
煤氣熱水爐 Gas water heater	TGC	TNJW221	Y	-	Y	-	-	-	Y	-	Y	-	-	-	Y	-	-	
		161TFQL	-	Y	-	-	-	-	-	Y	-	-	-	-	-	-	Y	Y

賣方承諾如期數中沒有安裝指明的品牌名稱或產品型號的升降機或設備，便會安裝品質相若的升降機或設備。

備註：

- "Y" 表示此設備於該住宅物業內提供及 / 或安裝。
- 上表 "-" 代表不適用。
- 第1座 (1A及1B) 不設13樓、14樓及24樓，9樓為庇護層。
- 第2座 (2A及2B) 不設13樓、14樓、24樓及34樓，9樓為庇護層。

The Vendor undertakes that if lifts or appliances of the specified brand name or model number are not installed in the Phase, lifts or appliances of comparable quality will be installed.

Notes:

- "Y" means such appliance(s) is / are provided and / or installed in the residential property.
- The symbol "-" as shown in the above table denotes "Not applicable".
- 13/F, 14/F and 24/F are omitted in Tower 1 (1A and 1B) and 9/F is refuge floor.
- 13/F, 14/F, 24/F and 34/F are omitted in Tower 2 (2A and 2B) and 9/F is refuge floor.

設備說明表 Appliances Schedule

設備 Appliance	品牌 Brand	型號 Model No.	第2座 (2A) Tower 2 (2A)														
			5樓 5/F						6樓至8樓、10樓至12樓、15樓至23樓、 25樓至33樓及35樓至37樓 6/F-8/F, 10/F-12/F, 15/F-23/F, 25/F-33/F & 35/F-37/F						38樓 38/F		
			A	B	C	D	E	F	A	B	C	D	E	F	A	B	C
雙頭氣體煮食爐 Gas hob - 2 burners	Gaggenau	VG232320HK	Y	Y	Y	Y	-	-	Y	Y	Y	Y	-	-	Y	Y	Y
單頭氣體煮食爐 Gas hob - 1 burner		VG231320HK	Y	Y	Y	Y	-	Y	Y	Y	Y	Y	-	Y	Y	Y	Y
電磁爐 Induction hob		VI232120	Y	Y	Y	Y	Y	Y	Y	Y	Y	Y	Y	Y	Y	Y	Y
抽油煙機 Cooker hood		AF210162	-	-	-	-	Y	Y	-	-	-	-	Y	Y	-	-	-
		AF210192	-	Y	Y	-	-	-	-	Y	Y	-	-	-	-	-	-
		AW240191	Y	-	-	Y	-	-	Y	-	-	Y	-	-	-	-	Y
		AW442120	-	-	-	-	-	-	-	-	-	-	-	-	-	Y	Y
蒸焗爐 Combi-steam oven		BSP250111 / BSP251111	Y	Y	Y	Y	Y	Y	Y	Y	Y	Y	Y	Y	-	-	-
蒸爐 Steamer		BSP220111 / BSP221111	-	-	-	-	-	-	-	-	-	-	-	-	Y	Y	Y
焗爐 Oven		BOP210112 / BOP211112	-	-	-	-	-	-	-	-	-	-	-	-	Y	-	Y
		EB333111	-	-	-	-	-	-	-	-	-	-	-	-	-	Y	-
洗碗碟機 Dishwasher		DF480100	-	-	-	-	-	-	-	-	-	-	-	-	Y	Y	-
咖啡機 Coffee machine		CMP250112	-	-	-	-	-	-	-	-	-	-	-	-	Y	Y	Y
雪櫃 Fridge freezer		RB280304	-	Y	Y	-	Y	Y	-	Y	Y	-	Y	Y	-	-	-
		RB472303	Y	-	-	Y	-	-	Y	-	-	Y	-	-	-	-	-
		RY492303	-	-	-	-	-	-	-	-	-	-	-	-	-	-	-
		Sub-zero	ICBIT-30CIID	-	-	-	-	-	-	-	-	-	-	-	-	-	-
ICBBI-36UFDID			-	-	-	-	-	-	-	-	-	-	-	-	Y	Y	-
洗衣乾衣機 Washer dryer		Gaggenau	WD200140	Y	Y	Y	Y	Y	Y	Y	Y	Y	Y	Y	Y	-	Y
洗衣機 Washer			WM260164	-	-	-	-	-	-	-	-	-	-	-	-	Y	-

賣方承諾如期數中沒有安裝指明的品牌名稱或產品型號的升降機或設備，便會安裝品質相若的升降機或設備。

備註：

- "Y" 表示此設備於該住宅物業內提供及 / 或安裝。
- 上表 "-" 代表不適用。
- 第1座 (1A及1B) 不設13樓、14樓及24樓，9樓為庇護層。
- 第2座 (2A及2B) 不設13樓、14樓、24樓及34樓，9樓為庇護層。

The Vendor undertakes that if lifts or appliances of the specified brand name or model number are not installed in the Phase, lifts or appliances of comparable quality will be installed.

Notes:

- "Y" means such appliance(s) is / are provided and / or installed in the residential property.
- The symbol "-" as shown in the above table denotes "Not applicable".
- 13/F, 14/F and 24/F are omitted in Tower 1 (1A and 1B) and 9/F is refuge floor.
- 13/F, 14/F, 24/F and 34/F are omitted in Tower 2 (2A and 2B) and 9/F is refuge floor.

設備說明表 Appliances Schedule

設備 Appliance	品牌 Brand	型號 Model No.	第2座 (2A) Tower 2 (2A)															
			5樓 5/F						6樓至8樓、10樓至12樓、15樓至23樓、 25樓至33樓及35樓至37樓 6/F-8/F, 10/F-12/F, 15/F-23/F, 25/F-33/F & 35/F-37/F						38樓 38/F			
			A	B	C	D	E	F	A	B	C	D	E	F	A	B	C	
乾衣機 Dryer	Gaggenau	WT260110	-	-	-	-	-	-	-	-	-	-	-	-	-	-	Y	-
酒櫃 Wine cellar		RW404261	-	-	-	-	-	-	-	-	-	-	-	-	-	-	Y	-
酒櫃 Wine cellar	名望 Vinvautz	VZ19SSUG	Y	-	-	Y	-	-	-	Y	-	-	Y	-	-	Y	-	Y
視像對講機 Video door phone	Urmet	NEXO 1708/1	Y	Y	Y	Y	Y	Y	Y	Y	Y	Y	Y	Y	Y	Y	Y	Y
分體式變頻冷暖空調機 (室內機) Split type inverter heat pump air-conditioner (Indoor unit)	樂聲牌 Panasonic	CS-Z50TKEW	-	-	-	-	Y	-	-	-	-	-	Y	-	-	-	-	-
		CS-Z42TKEW	-	Y	-	Y	-	Y	-	Y	Y	Y	Y	-	Y	-	-	-
		CS-Z25TKEW	-	Y	-	Y	Y	Y	-	Y	Y	Y	Y	Y	Y	-	-	-
		CS-YE24UKA1	-	-	-	-	-	Y	-	-	-	-	-	Y	-	-	-	
分體式變頻冷暖空調機 (室外機) Split type inverter heat pump air-conditioner (Outdoor unit)		CU-5E34PBE	-	-	-	-	Y	-	-	-	-	-	Y	-	-	-	-	-
		CU-4E23PBE	-	Y	-	Y	-	Y	-	Y	Y	Y	-	Y	-	-	-	
		CU-YE24UKA1	-	-	-	-	-	Y	-	-	-	-	-	Y	-	-	-	
可變冷媒流量空調機 (室內機) Variable refrigerant volume air-conditioner (Indoor unit)		S-73MK2E5A	-	-	-	-	-	-	-	-	-	-	-	-	-	-	Y	-
		S-56MK2E5A	-	-	-	-	-	-	-	-	-	-	-	-	-	Y	-	Y
		S-45MK2E5A	Y	-	Y	-	-	-	Y	-	-	-	-	-	-	Y	Y	Y
	S-28MK2E5A	Y	-	Y	-	-	-	Y	-	-	-	-	-	-	Y	-	Y	
可變冷媒流量風管式空調機 (室內機) Variable refrigerant volume duct type air-conditioner (Indoor unit)	S-22MK2E5A	Y	-	-	-	-	-	Y	-	-	-	-	-	Y	Y	Y		
	S-28MF2E5A	-	-	-	-	-	-	-	-	-	-	-	-	Y	Y	Y		

賣方承諾如期數中沒有安裝指明的品牌名稱或產品型號的升降機或設備，便會安裝品質相若的升降機或設備。

備註：

- "Y" 表示此設備於該住宅物業內提供及 / 或安裝。
- 上表 "-" 代表不適用。
- 第1座 (1A及1B) 不設13樓、14樓及24樓，9樓為庇護層。
- 第2座 (2A及2B) 不設13樓、14樓、24樓及34樓，9樓為庇護層。

The Vendor undertakes that if lifts or appliances of the specified brand name or model number are not installed in the Phase, lifts or appliances of comparable quality will be installed.

Notes:

- "Y" means such appliance(s) is / are provided and / or installed in the residential property.
- The symbol "-" as shown in the above table denotes "Not applicable".
- 13/F, 14/F and 24/F are omitted in Tower 1 (1A and 1B) and 9/F is refuge floor.
- 13/F, 14/F, 24/F and 34/F are omitted in Tower 2 (2A and 2B) and 9/F is refuge floor.

設備說明表 Appliances Schedule

設備 Appliance	品牌 Brand	型號 Model No.	第2座 (2A) Tower 2 (2A)																
			5樓 5/F						6樓至8樓、10樓至12樓、15樓至23樓、 25樓至33樓及35樓至37樓 6/F-8/F, 10/F-12/F, 15/F-23/F, 25/F-33/F & 35/F-37/F						38樓 38/F				
			A	B	C	D	E	F	A	B	C	D	E	F	A	B	C		
可變冷媒流量空調機 (室外機) Variable refrigerant volume air-conditioner (Outdoor unit)	樂聲牌 Panasonic	U-6LE2H7	-	-	-	-	-	-	-	-	-	-	-	-	-	Y	-	-	
		U-5LE2H7	-	-	-	-	-	-	-	-	-	-	-	-	-	Y	-	-	
		U-8LE1H7	-	-	Y	-	-	-	-	-	-	-	-	-	-	-	-	Y	Y
		U-4LE2H7	Y	-	-	-	-	-	-	Y	-	-	-	-	-	-	-	-	Y
抽氣扇 Exhaust fan	奧斯博格 Ostberg	LPK 125 B1-c	Y	Y	Y	Y	-	Y	Y	Y	Y	Y	-	Y	Y	Y	Y		
	樂聲牌 Panasonic	FV-04NU1H	-	-	Y	-	Y	-	-	-	Y	-	Y	-	-	Y	-		
換氣暖風機 Thermo ventilator	樂聲牌 Panasonic	FV-40BE3H2	Y	Y	Y	Y	Y	Y	Y	Y	Y	Y	Y	Y	Y	Y	Y		
電熱水爐 Electric water heater	斯寶亞創 Stiebel Eltron	DHB-E 27 LCD	Y	Y	Y	Y	Y	-	Y	Y	Y	Y	Y	-	Y	Y	Y		
煤氣熱水爐 Gas water heater	TGC	TNJW221	-	-	-	-	-	-	-	-	-	-	-	-	Y	-	-		
		161TFQL	Y	Y	Y	Y	-	Y	Y	Y	Y	Y	-	Y	-	Y	Y		

賣方承諾如期數中沒有安裝指明的品牌名稱或產品型號的升降機或設備，便會安裝品質相若的升降機或設備。

備註：

- "Y" 表示此設備於該住宅物業內提供及 / 或安裝。
- 上表 "-" 代表不適用。
- 第1座 (1A及1B) 不設13樓、14樓及24樓，9樓為庇護層。
- 第2座 (2A及2B) 不設13樓、14樓、24樓及34樓，9樓為庇護層。

The Vendor undertakes that if lifts or appliances of the specified brand name or model number are not installed in the Phase, lifts or appliances of comparable quality will be installed.

Notes:

- "Y" means such appliance(s) is / are provided and / or installed in the residential property.
- The symbol "-" as shown in the above table denotes "Not applicable".
- 13/F, 14/F and 24/F are omitted in Tower 1 (1A and 1B) and 9/F is refuge floor.
- 13/F, 14/F, 24/F and 34/F are omitted in Tower 2 (2A and 2B) and 9/F is refuge floor.

設備說明表 Appliances Schedule

設備 Appliance	品牌 Brand	型號 Model No.	第2座 (2B) Tower 2 (2B)																												
			5樓 5/F				6樓至8樓 6/F-8/F							10樓至12樓、15樓至23樓、 25樓至33樓及35樓至36樓 10/F-12/F, 15/F-23/F, 25/F-33/F & 35/F-36/F							37樓 37/F					37樓及38樓 (複式) 37/F & 38/F (Duplex)			38樓 38/F		
			A	B	C	G	A	B	C	D	E	F	G	A	B	C	E	F	G	B	C	E	F	G	A	B	C				
雙頭氣體煮食爐 Gas hob - 2 burners	Gaggenau	VG232320HK	-	-	-	-	-	-	-	-	-	-	-	-	-	-	-	-	-	-	-	-	-	-	-	-	-	Y	Y	Y	
單頭氣體煮食爐 Gas hob - 1 burner		VG231320HK	Y	Y	-	-	Y	Y	-	-	Y	-	-	Y	Y	Y	-	-	Y	Y	Y	-	-	Y	Y	Y	-	-	Y	Y	Y
電磁爐 Induction hob		VI232120	Y	Y	-	-	Y	Y	-	Y	Y	Y	-	Y	Y	Y	Y	-	Y	Y	Y	Y	-	Y	Y	Y	Y	-	Y	Y	Y
		CI262115	-	-	Y	Y	-	-	Y	-	-	-	Y	-	-	-	-	-	Y	-	-	-	-	Y	-	-	-	-	Y	-	-
抽油煙機 Cooker hood		AF210162	Y	Y	Y	Y	Y	Y	Y	Y	Y	Y	Y	Y	Y	Y	Y	Y	Y	Y	Y	Y	Y	Y	Y	Y	Y	Y	-	-	-
		AW240191	-	-	-	-	-	-	-	-	-	-	-	-	-	-	-	-	-	-	-	-	-	-	-	-	-	-	Y	-	Y
		AW442120	-	-	-	-	-	-	-	-	-	-	-	-	-	-	-	-	-	-	-	-	-	-	-	-	-	-	-	Y	-
蒸焗爐 Combi-steam oven		BSP250111 / BSP251111	Y	Y	Y	Y	Y	Y	Y	Y	Y	Y	Y	Y	Y	Y	Y	Y	Y	Y	Y	Y	Y	Y	Y	Y	Y	-	-	-	
蒸爐 Steamer		BSP220111 / BSP221111	-	-	-	-	-	-	-	-	-	-	-	-	-	-	-	-	-	-	-	-	-	-	-	-	-	Y	Y	Y	
焗爐 Oven		BOP210112 / BOP211112	-	-	-	-	-	-	-	-	-	-	-	-	-	-	-	-	-	-	-	-	-	-	-	-	-	Y	Y	Y	
洗碗碟機 Dishwasher		DF480100	-	-	-	-	-	-	-	-	-	-	-	-	-	-	-	-	-	-	-	-	-	-	-	-	-	-	Y	-	
咖啡機 Coffee machine		CMP250112	-	-	-	-	-	-	-	-	-	-	-	-	-	-	-	-	-	-	-	-	-	-	-	-	-	Y	Y	Y	
雪櫃 Fridge freezer		RB280304	Y	Y	Y	Y	Y	Y	Y	Y	Y	Y	Y	Y	Y	Y	Y	Y	Y	Y	Y	Y	Y	Y	Y	Y	Y	-	-	-	
		RB472303	-	-	-	-	-	-	-	-	-	-	-	-	-	-	-	-	-	-	-	-	-	-	-	-	-	-	-	-	-
		RY492303	-	-	-	-	-	-	-	-	-	-	-	-	-	-	-	-	-	-	-	-	-	-	-	-	-	-	-	-	-
		Sub-zero	ICBIT-30CIID	-	-	-	-	-	-	-	-	-	-	-	-	-	-	-	-	-	-	-	-	-	-	-	-	-	Y	-	Y
			ICBBI-36UFDID	-	-	-	-	-	-	-	-	-	-	-	-	-	-	-	-	-	-	-	-	-	-	-	-	-	-	Y	-
洗衣乾衣機 Washer dryer		WD200140	Y	Y	Y	Y	Y	Y	Y	Y	Y	Y	Y	Y	Y	Y	Y	Y	Y	Y	Y	Y	Y	Y	Y	Y	Y	-	-	Y	
		WD220140	-	-	-	-	-	-	-	-	-	-	-	-	-	-	-	-	-	-	-	-	-	-	-	-	-	Y	-	-	
洗衣機 Washer		WM260164	-	-	-	-	-	-	-	-	-	-	-	-	-	-	-	-	-	-	-	-	-	-	-	-	-	-	Y	-	

賣方承諾如期數中沒有安裝指明的品牌名稱或產品型號的升降機或設備，便會安裝品質相若的升降機或設備。

備註：

1. "Y" 表示此設備於該住宅物業內提供及 / 或安裝。
2. 上表 "-" 代表不適用。
3. 第1座 (1A 及 1B) 不設 13 樓、14 樓及 24 樓，9 樓為庇護層。
4. 第2座 (2A 及 2B) 不設 13 樓、14 樓、24 樓及 34 樓，9 樓為庇護層。

The Vendor undertakes that if lifts or appliances of the specified brand name or model number are not installed in the Phase, lifts or appliances of comparable quality will be installed.

Notes:

1. "Y" means such appliance(s) is / are provided and / or installed in the residential property.
2. The symbol "-" as shown in the above table denotes "Not applicable".
3. 13/F, 14/F and 24/F are omitted in Tower 1 (1A and 1B) and 9/F is refuge floor.
4. 13/F, 14/F, 24/F and 34/F are omitted in Tower 2 (2A and 2B) and 9/F is refuge floor.

設備說明表
Appliances Schedule

設備 Appliance	品牌 Brand	型號 Model No.	第2座(2B) Tower 2 (2B)																												
			5樓 5/F				6樓至8樓 6/F-8/F								10樓至12樓、15樓至23樓、 25樓至33樓及35樓至36樓 10/F-12/F, 15/F-23/F, 25/F-33/F & 35/F-36/F								37樓 37/F					37樓及38樓 (複式) 37/F & 38/F (Duplex)		38樓 38/F	
			A	B	C	G	A	B	C	D	E	F	G	A	B	C	E	F	G	B	C	E	F	G	A	B	C				
乾衣機 Dryer	Gaggenau	WT260110	-	-	-	-	-	-	-	-	-	-	-	-	-	-	-	-	-	-	-	-	-	-	-	-	-	Y	-		
酒櫃 Wine cellar		RW404261	-	-	-	-	-	-	-	-	-	-	-	-	-	-	-	-	-	-	-	-	-	-	-	-	-	Y	-		
酒櫃 Wine cellar	名望 Vinvautz	VZ19SSUG	-	-	-	-	-	-	-	-	-	-	-	-	-	-	-	-	-	-	-	-	-	-	-	-	Y	-	Y		
視像對講機 Video door phone	Urmet	NEXO 1708/1	Y	Y	Y	Y	Y	Y	Y	Y	Y	Y	Y	Y	Y	Y	Y	Y	Y	Y	Y	Y	Y	Y	Y	Y	Y	Y	Y		
分體式變頻冷暖空調機 (室內機) Split type inverter heat pump air-conditioner (Indoor unit)	樂聲牌 Panasonic	CS-Z50TKEW	-	-	-	-	-	-	Y	-	Y	-	-	-	-	-	Y	-	-	-	-	Y	-	-	-	-	-	-	-		
		CS-Z42TKEW	Y	Y	-	Y	Y	Y	-	-	Y	-	Y	Y	Y	Y	Y	-	Y	Y	Y	Y	-	Y	-	Y	-	-	-		
		CS-Z25TKEW	Y	Y	-	Y	Y	Y	-	Y	Y	Y	Y	Y	Y	Y	Y	Y	Y	Y	Y	Y	Y	Y	Y	Y	Y	-	-	-	
		CS-YE24UKA1	Y	Y	-	-	Y	Y	-	-	Y	-	-	Y	Y	Y	Y	-	-	Y	Y	Y	-	-	-	-	-	-	-	-	
		CS-YE18UKA1	-	-	-	Y	-	-	-	-	-	-	Y	-	-	-	-	-	Y	-	-	-	-	Y	-	-	-	Y	-	-	
分體式變頻冷暖空調機 (室外機) Split type inverter heat pump air-conditioner (Outdoor unit)	樂聲牌 Panasonic	CU-5E34PBE	-	-	-	-	-	-	Y	-	Y	-	-	-	-	-	Y	-	-	-	-	Y	-	-	-	Y	-	-	-		
		CU-4E23PBE	Y	Y	-	Y	Y	Y	-	-	Y	-	Y	Y	Y	Y	Y	-	Y	Y	Y	Y	-	Y	-	Y	-	-	-		
		CU-2E18SBE	-	-	-	-	-	-	-	-	-	-	-	-	-	Y	-	-	-	-	Y	-	-	-	-	-	-	-	-	-	
		CU-YE24UKA1	Y	Y	-	-	Y	Y	-	-	Y	-	-	Y	Y	Y	Y	-	-	Y	Y	Y	-	-	-	-	-	-	-	-	
		CU-YE18UKA1	-	-	-	Y	-	-	-	-	-	-	Y	-	-	-	-	-	Y	-	-	-	-	Y	-	-	-	Y	-	-	
可變冷媒流量空調機 (室內機) Variable refrigerant volume air-conditioner (Indoor unit)	樂聲牌 Panasonic	S-73MK2E5A	-	-	-	-	-	-	-	-	-	-	-	-	-	-	-	-	-	-	-	-	-	-	-	-	-	Y	Y	-	
		S-56MK2E5A	-	-	Y	-	-	-	Y	-	-	-	-	-	-	-	-	-	-	-	-	-	-	-	-	-	-	-	Y	-	-
		S-45MK2E5A	-	-	Y	-	-	-	Y	-	-	-	-	-	-	-	-	-	-	-	-	-	-	-	-	-	-	-	Y	Y	Y
		S-28MK2E5A	-	-	-	-	-	-	-	-	-	-	-	-	-	-	-	-	-	-	-	-	-	-	-	-	-	-	Y	Y	Y
		S-22MK2E5A	-	-	Y	-	-	-	Y	-	-	-	-	-	-	-	-	-	-	-	-	-	-	-	-	-	-	-	Y	Y	Y

賣方承諾如期數中沒有安裝指明的品牌名稱或產品型號的升降機或設備，便會安裝品質相若的升降機或設備。

備註：

- "Y" 表示此設備於該住宅物業內提供及 / 或安裝。
- 上表 "-" 代表不適用。
- 第1座 (1A 及 1B) 不設 13 樓、14 樓及 24 樓，9 樓為庇護層。
- 第2座 (2A 及 2B) 不設 13 樓、14 樓、24 樓及 34 樓，9 樓為庇護層。

The Vendor undertakes that if lifts or appliances of the specified brand name or model number are not installed in the Phase, lifts or appliances of comparable quality will be installed.

Notes:

- "Y" means such appliance(s) is / are provided and / or installed in the residential property.
- The symbol "-" as shown in the above table denotes "Not applicable".
- 13/F, 14/F and 24/F are omitted in Tower 1 (1A and 1B) and 9/F is refuge floor.
- 13/F, 14/F, 24/F and 34/F are omitted in Tower 2 (2A and 2B) and 9/F is refuge floor.

設備說明表

Appliances Schedule

設備 Appliance	品牌 Brand	型號 Model No.	第2座 (2B) Tower 2 (2B)																															
			5樓 5/F				6樓至8樓 6/F-8/F								10樓至12樓、15樓至23樓、 25樓至33樓及35樓至36樓 10/F-12/F, 15/F-23/F, 25/F-33/F & 35/F-36/F						37樓 37/F					37樓及38樓 (複式) 37/F & 38/F (Duplex)			38樓 38/F					
			A	B	C	G	A	B	C	D	E	F	G	A	B	C	E	F	G	B	C	E	F	G	A	B	C							
可變冷媒流量風管式空調機 (室內機) Variable refrigerant volume duct type air-conditioner (Indoor unit)	樂聲牌 Panasonic	S-45MF2E5A	-	-	-	-	-	-	-	-	-	-	-	-	-	-	-	-	-	-	-	-	-	-	-	-	-	-	-	-	Y	-	-	
		S-28MF2E5A	-	-	-	-	-	-	-	-	-	-	-	-	-	-	-	-	-	-	-	-	-	-	-	-	-	-	-	-	-	-	Y	Y
可變冷媒流量空調機 (室外機) Variable refrigerant volume air-conditioner (Outdoor unit)		U-8LE1H7	-	-	-	-	-	-	-	-	-	-	-	-	-	-	-	-	-	-	-	-	-	-	-	-	-	-	-	-	Y	-	-	
		U-6LE2H7	-	-	-	-	-	-	-	-	-	-	-	-	-	-	-	-	-	-	-	-	-	-	-	-	-	-	-	-	-	Y	Y	
		U-4LE2H7	-	-	-	-	-	-	-	-	-	-	-	-	-	-	-	-	-	-	-	-	-	-	-	-	-	-	-	-	-	-	Y	-
		U-5LE2H7	-	-	Y	-	-	-	Y	-	-	-	-	-	-	-	-	-	-	-	-	-	-	-	-	-	-	-	-	-	Y	-	-	
抽氣扇 Exhaust fan	奧斯博格 Ostberg	LPK 125 B1-c	Y	Y	-	-	Y	Y	-	-	Y	-	-	Y	Y	Y	Y	-	-	Y	Y	Y	-	-	Y	Y	Y	-	-	Y	Y	Y		
	樂聲牌 Panasonic	FV-04NU1H	-	-	-	Y	-	-	-	Y	Y	Y	Y	-	-	-	Y	Y	Y	-	-	Y	Y	Y	-	-	Y	Y	Y	-	-	Y	Y	
換氣暖風機 Thermo ventilator	樂聲牌 Panasonic	FV-40BE3H2	Y	Y	Y	Y	Y	Y	Y	Y	Y	Y	Y	Y	Y	Y	Y	Y	Y	Y	Y	Y	Y	Y	Y	Y	Y	Y	Y	Y	Y	Y	Y	
電熱水爐 Electric water heater	斯寶亞創 Stiebel Eltron	DHB-E 27 LCD	-	-	Y	Y	-	-	Y	Y	-	Y	Y	-	-	Y	-	Y	Y	-	Y	-	Y	Y	-	-	Y	Y	Y	Y	Y	Y	Y	
煤氣熱水爐 Gas water heater	TGC	TNJW221	Y	-	-	-	Y	-	-	-	-	-	-	Y	-	-	-	-	-	-	-	-	-	-	-	-	-	-	-	-	-	Y	-	
		161TFQL	-	Y	-	-	-	Y	-	-	Y	-	-	-	-	Y	Y	Y	-	-	Y	Y	Y	-	-	Y	Y	Y	-	-	Y	-	Y	

賣方承諾如期數中沒有安裝指明的品牌名稱或產品型號的升降機或設備，便會安裝品質相若的升降機或設備。

備註：

- "Y" 表示此設備於該住宅物業內提供及 / 或安裝。
- 上表 "-" 代表不適用。
- 第1座 (1A及1B) 不設13樓、14樓及24樓，9樓為庇護層。
- 第2座 (2A及2B) 不設13樓、14樓、24樓及34樓，9樓為庇護層。

The Vendor undertakes that if lifts or appliances of the specified brand name or model number are not installed in the Phase, lifts or appliances of comparable quality will be installed.

Notes:

- "Y" means such appliance(s) is / are provided and / or installed in the residential property.
- The symbol "-" as shown in the above table denotes "Not applicable".
- 13/F, 14/F and 24/F are omitted in Tower 1 (1A and 1B) and 9/F is refuge floor.
- 13/F, 14/F, 24/F and 34/F are omitted in Tower 2 (2A and 2B) and 9/F is refuge floor.

住宅物業機電裝置數量說明表
Schedule of Mechanical & Electrical Provisions of Residential Properties

位置 Location	描述 Description	第1座 (1A) Tower 1 (1A)												
		5樓 5/F					6樓至8樓、10樓至12樓、15樓至23樓及 25樓至31樓 (27樓A單位除外) 6/F-8/F, 10/F-12/F, 15/F-23/F & 25/F-31/F (Except Unit A on 27/F)					27樓 27/F	32樓 32/F	
		A	B	C	D	E	A	B	C	D	E	A	A	B
大門入口 Main Entrance	門鈴按鈕 Door bell push button	1	1	1	1	1	1	1	1	1	1	1	1	1
客廳/飯廳 Living Room / Dining Room	電視/電台天線接駁位 TV/FM outlet	2	2	2	2	2	2	2	2	2	2	2	2	2
	電話接駁位 Telephone outlet	2	2	2	2	2	2	2	2	2	2	2	2	2
	互聯網接駁位 Internet connection point	3	3	-	3	-	3	3	-	3	-	4	3	3
	單位電插座 Single socket outlet	-	-	-	-	-	-	-	-	-	-	4	1	-
	單位電插座 (連USB插座) Single socket outlet (with USB socket)	-	-	1	-	1	-	-	1	-	1	-	-	-
	雙位電插座 Twin socket outlet	3	3	2	3	2	3	3	2	3	2	3	3	3
	空調機開關掣 Switch for air-conditioner unit	2	2	1	2	1	2	2	1	2	1	2	3	3
	電窗簾預留接駁位 Reserved connection point for electric curtain	1	-	-	-	-	1	-	-	-	-	1	2	2
	抽氣扇開關掣 Exhaust fan switch	2	2	-	2	-	2	2	-	2	-	2	2	2
	總電掣箱 Miniature circuit breakers board	-	-	1	-	1	-	-	1	-	1	-	-	-
	燈掣 Lighting switch	5	5	5	5	5	5	5	5	5	5	9	8	8
	燈位 Lighting point	6	4	4	4	4	6	4	4	4	4	35	7	11
	門鐘 Door bell	-	-	1	-	1	-	-	1	-	1	-	-	-
	保安系統閃燈警鐘 Audio visual security alarm	-	-	1	-	1	-	-	-	-	-	-	-	-
	保安系統開關掣 Switch for security system	-	-	1	-	1	-	-	-	-	-	-	-	-
	保安系統保險非士蘇 Fused spur unit for security system	-	-	1	-	1	-	-	-	-	-	-	-	-
	保安系統面板 Security system panel	-	-	1	-	1	-	-	-	-	-	-	-	-
	視像對講機 Video door phone	1	1	1	1	1	1	1	1	1	1	1	1	1
煙霧探測器及蜂鳴底座 Smoke detector with sounder base	-	-	1	-	1	-	-	1	-	1	-	-	-	
調光系統單位電插座 Single socket outlet for dimming system	-	-	-	-	-	-	-	-	-	-	-	1	1	

備註:

1. 上表所顯示的“1, 2,”表示提供於該住宅物業內的裝置數量。
2. 上表“-”代表不適用。
3. 第1座 (1A及1B) 不設13樓、14樓及24樓，9樓為庇護層。
4. 第2座 (2A及2B) 不設13樓、14樓、24樓及34樓，9樓為庇護層。

Notes:

1. “1, 2,” as shown in the schedule above denotes the quantity of such provision(s) provided in the residential unit.
2. The symbol “-” as shown in the schedule above denotes “Not applicable”.
3. 13/F, 14/F and 24/F are omitted in Tower 1 (1A and 1B) and 9/F is refuge floor.
4. 13/F, 14/F, 24/F and 34/F are omitted in Tower 2 (2A and 2B) and 9/F is refuge floor.

住宅物業機電裝置數量說明表
Schedule of Mechanical & Electrical Provisions of Residential Properties

位置 Location	描述 Description	第1座 (1A) Tower 1 (1A)													
		5樓 5/F					6樓至8樓、10樓至12樓、15樓至23樓及 25樓至31樓 (27樓A單位除外) 6/F-8/F, 10/F-12/F, 15/F-23/F & 25/F-31/F (Except Unit A on 27/F)					27樓 27/F	32樓 32/F		
		A	B	C	D	E	A	B	C	D	E	A	A	B	
主人睡房 Master Bedroom	電視/電台天線接駁位 TV/FM outlet	1	1	1	1	1	1	1	1	1	1	1	1	1	1
	電話接駁位 Telephone outlet	1	1	1	1	1	1	1	1	1	1	1	1	1	1
	互聯網接駁位 Internet connection point	1	1	-	1	-	1	1	-	1	-	1	1	1	1
	單位電插座 Single socket outlet	3	3	2	3	2	3	3	2	3	2	5	3	3	
	單位電插座 (連USB插座) Single socket outlet (with USB socket)	1	1	1	1	1	1	1	1	1	1	-	1	1	
	雙位電插座 Twin socket outlet	-	-	-	-	-	-	-	-	-	-	1	-	-	
	空調機開關掣 Switch for air-conditioner unit	1	1	1	1	1	1	1	1	1	1	1	2	1	
	電窗簾預留接駁位 Reserved connection point for electric curtain	1	-	-	-	-	1	-	-	-	-	1	1	1	
	燈掣 Lighting switch	2	2	1	3	1	2	3	2	3	2	6	2	3	
	燈位 Lighting point	2	1	1	1	1	2	1	1	1	1	10	2	1	
睡房 Bedroom	電視/電台天線接駁位 TV/FM outlet	-	-	1	-	1	-	-	1	-	1	-	-	-	
	電話接駁位 Telephone outlet	-	-	1	-	1	-	-	1	-	1	-	-	-	
	單位電插座 Single socket outlet	-	-	1	-	1	-	-	1	-	1	-	-	-	
	單位電插座 (連USB插座) Single socket outlet (with USB socket)	-	-	1	-	1	-	-	1	-	1	-	-	-	
	空調機開關掣 Switch for air-conditioner unit	-	-	1	-	1	-	-	1	-	1	-	-	-	
	燈掣 Lighting switch	-	-	1	-	1	-	-	1	-	1	-	-	-	
	燈位 Lighting point	-	-	1	-	1	-	-	1	-	1	-	-	-	

備註:

1. 上表所顯示的“1, 2,”表示提供於該住宅物業內的裝置數量。
2. 上表“-”代表不適用。
3. 第1座 (1A及1B) 不設13樓、14樓及24樓，9樓為庇護層。
4. 第2座 (2A及2B) 不設13樓、14樓、24樓及34樓，9樓為庇護層。

Notes:

1. “1, 2,” as shown in the schedule above denotes the quantity of such provision(s) provided in the residential unit.
2. The symbol “-” as shown in the schedule above denotes “Not applicable”.
3. 13/F, 14/F and 24/F are omitted in Tower 1 (1A and 1B) and 9/F is refuge floor.
4. 13/F, 14/F, 24/F and 34/F are omitted in Tower 2 (2A and 2B) and 9/F is refuge floor.

住宅物業機電裝置數量說明表
Schedule of Mechanical & Electrical Provisions of Residential Properties

位置 Location	描述 Description	第1座 (1A) Tower 1 (1A)												
		5樓 5/F					6樓至8樓、10樓至12樓、15樓至23樓及 25樓至31樓 (27樓A單位除外) 6/F-8/F, 10/F-12/F, 15/F-23/F & 25/F-31/F (Except Unit A on 27/F)					27樓 27/F	32樓 32/F	
		A	B	C	D	E	A	B	C	D	E	A	A	B
睡房1 Bedroom 1	電視/電台天線接駁位 TV/FM outlet	1	1	-	1	-	1	1	-	1	-	1	1	1
	電話接駁位 Telephone outlet	1	1	-	1	-	1	1	-	1	-	1	1	1
	互聯網接駁位 Internet connection point	1	1	-	1	-	1	1	-	1	-	2	1	1
	單位電插座 Single socket outlet	1	1	-	1	-	1	1	-	1	-	2	1	1
	單位電插座 (連USB插座) Single socket outlet (with USB socket)	1	1	-	1	-	1	1	-	1	-	-	1	1
	空調機開關掣 Switch for air-conditioner unit	1	1	-	1	-	1	1	-	1	-	1	1	1
	電窗簾預留接駁位 Reserved connection point for electric curtain	1	-	-	-	-	1	-	-	-	-	1	1	1
	燈掣 Lighting switch	1	1	-	1	-	1	1	-	1	-	1	2	1
	抽氣扇開關掣 Exhaust fan switch	-	-	-	-	-	-	-	-	-	-	-	1	-
燈位 Lighting point	1	1	-	1	-	1	1	-	1	-	4	1	1	
睡房2 Bedroom 2	電視/電台天線接駁位 TV/FM outlet	1	1	-	1	-	1	1	-	1	-	1	1	1
	電話接駁位 Telephone outlet	1	1	-	1	-	1	1	-	1	-	1	1	1
	互聯網接駁位 Internet connection point	1	1	-	1	-	1	1	-	1	-	1	1	1
	單位電插座 Single socket outlet	1	1	-	1	-	1	1	-	1	-	3	1	1
	單位電插座 (連USB插座) Single socket outlet (with USB socket)	1	1	-	1	-	1	1	-	1	-	-	1	1
	空調機開關掣 Switch for air-conditioner unit	1	1	-	1	-	1	1	-	1	-	1	1	1
	電窗簾預留接駁位 Reserved connection point for electric curtain	1	-	-	-	-	1	-	-	-	-	1	1	1
	燈掣 Lighting switch	1	1	-	1	-	1	1	-	1	-	2	1	1
燈位 Lighting point	1	1	-	1	-	1	1	-	1	-	5	1	1	
睡房3 Bedroom 3	電視/電台天線接駁位 TV/FM outlet	1	-	-	-	-	1	-	-	-	-	1	1	-
	電話接駁位 Telephone outlet	1	-	-	-	-	1	-	-	-	-	1	1	-
	互聯網接駁位 Internet connection point	1	-	-	-	-	1	-	-	-	-	2	1	-
	單位電插座 Single socket outlet	1	-	-	-	-	1	-	-	-	-	3	3	-
	單位電插座 (連USB插座) Single socket outlet (with USB socket)	1	-	-	-	-	1	-	-	-	-	-	1	-
	雙位電插座 Twin socket outlet	-	-	-	-	-	-	-	-	-	-	1	-	-
	空調機開關掣 Switch for air-conditioner unit	1	-	-	-	-	1	-	-	-	-	1	1	-
	電窗簾預留接駁位 Reserved connection point for electric curtain	1	-	-	-	-	1	-	-	-	-	1	1	-
燈掣 Lighting switch	1	-	-	-	-	1	-	-	-	-	1	1	-	
燈位 Lighting point	1	-	-	-	-	1	-	-	-	-	5	2	-	

備註:

1. 上表所顯示的“1, 2,”表示提供於該住宅物業內的裝置數量。
2. 上表“-”代表不適用。
3. 第1座 (1A及1B) 不設13樓、14樓及24樓，9樓為庇護層。
4. 第2座 (2A及2B) 不設13樓、14樓、24樓及34樓，9樓為庇護層。

Notes:

1. “1, 2,” as shown in the schedule above denotes the quantity of such provision(s) provided in the residential unit.
2. The symbol “-” as shown in the schedule above denotes “Not applicable”.
3. 13/F, 14/F and 24/F are omitted in Tower 1 (1A and 1B) and 9/F is refuge floor.
4. 13/F, 14/F, 24/F and 34/F are omitted in Tower 2 (2A and 2B) and 9/F is refuge floor.

住宅物業機電裝置數量說明表

Schedule of Mechanical & Electrical Provisions of Residential Properties

位置 Location	描述 Description	第1座 (1A) Tower 1 (1A)												
		5樓 5/F					6樓至8樓、10樓至12樓、15樓至23樓及 25樓至31樓 (27樓A單位除外) 6/F-8/F, 10/F-12/F, 15/F-23/F & 25/F-31/F (Excpet Unit A on 27/F)					27樓 27/F	32樓 32/F	
		A	B	C	D	E	A	B	C	D	E	A	A	B
主人浴室 Master Bathroom	單位電插座 (鏡櫃內) Single socket outlet (at mirror cabinet)	1	1	-	1	-	1	1	-	1	-	1	2	1
	燈位 Lighting point	5	3	-	3	-	5	3	-	3	-	5	6	3
	換氣暖風機隔離開關掣 Isolator for thermo ventilator	1	1	-	1	-	1	1	-	1	-	1	1	1
	電熱水爐隔離開關掣 Isolator for electric water heater	1	1	-	1	-	1	1	-	1	-	1	1	1
	鏡子加熱器保險菲士蘇 Fused spur unit for mirror heater	-	-	-	-	-	-	-	-	-	-	-	1	1
浴室 Bathroom	單位電插座 (鏡櫃內) Single socket outlet (at mirror cabinet)	1	1	1	1	1	1	1	1	1	1	1	-	1
	煤氣熱水爐溫度控制器 Towngas water heater temperature controller	1	1	-	1	-	1	1	-	1	-	1	-	1
	燈位 Lighting point	3	3	3	3	3	3	3	3	3	3	3	-	3
	抽氣扇保險菲士蘇 Fused spur unit for exhaust fan	1	1	-	1	-	1	1	-	1	-	1	-	-
	換氣暖風機隔離開關掣 Isolator for thermo ventilator	-	-	1	-	1	-	-	1	-	1	-	-	-
	電熱水爐隔離開關掣 Isolator for electric water heater	-	-	1	-	1	-	-	1	-	1	-	-	-
浴室1 Bathroom 1	單位電插座 (鏡櫃內) Single socket outlet (at mirror cabinet)	-	-	-	-	-	-	-	-	-	-	-	1	-
	煤氣熱水爐溫度控制器 Towngas water heater temperature controller	-	-	-	-	-	-	-	-	-	-	-	1	-
	燈位 Lighting point	-	-	-	-	-	-	-	-	-	-	-	3	-
	鏡子加熱器保險菲士蘇 Fused spur unit for mirror heater	-	-	-	-	-	-	-	-	-	-	-	1	1
	抽氣扇保險菲士蘇 Fused spur unit for exhaust fan	-	-	-	-	-	-	-	-	-	-	-	1	1
浴室2 Bathroom 2	單位電插座 (鏡櫃內) Single socket outlet (at mirror cabinet)	-	-	-	-	-	-	-	-	-	-	-	1	-
	煤氣熱水爐溫度控制器 Towngas water heater temperature controller	-	-	-	-	-	-	-	-	-	-	-	1	-
	燈位 Lighting point	-	-	-	-	-	-	-	-	-	-	-	3	-
	鏡子加熱器保險菲士蘇 Fused spur unit for mirror heater	-	-	-	-	-	-	-	-	-	-	-	1	1
	抽氣扇保險菲士蘇 Fused spur unit for exhaust fan	-	-	-	-	-	-	-	-	-	-	-	1	1

備註：

1. 上表所顯示的“1, 2,”表示提供於該住宅物業內的裝置數量。
2. 上表“-”代表不適用。
3. 第1座 (1A及1B) 不設13樓、14樓及24樓，9樓為庇護層。
4. 第2座 (2A及2B) 不設13樓、14樓、24樓及34樓，9樓為庇護層。

Notes:

1. “1, 2,” as shown in the schedule above denotes the quantity of such provision(s) provided in the residential unit.
2. The symbol “-” as shown in the schedule above denotes “Not applicable”.
3. 13/F, 14/F and 24/F are omitted in Tower 1 (1A and 1B) and 9/F is refuge floor.
4. 13/F, 14/F, 24/F and 34/F are omitted in Tower 2 (2A and 2B) and 9/F is refuge floor.

住宅物業機電裝置數量說明表
Schedule of Mechanical & Electrical Provisions of Residential Properties

位置 Location	描述 Description	第1座 (1A) Tower 1 (1A)												
		5樓 5/F					6樓至8樓、10樓至12樓、15樓至23樓及 25樓至31樓 (27樓A單位除外) 6/F-8/F, 10/F-12/F, 15/F-23/F & 25/F-31/F (Except Unit A on 27/F)					27樓 27/F	32樓 32/F	
		A	B	C	D	E	A	B	C	D	E	A	A	B
開放式廚房 Open Kitchen	暗藏式灑水器 Concealed type sprinkler	-	-	1	-	1	-	-	1	-	1	-	-	-
	雙位電插座 Twin socket outlet	-	-	2	-	2	-	-	2	-	2	-	-	-
	廚房電器單位電插座 Single socket outlet for kitchen appliances	-	-	2	-	2	-	-	2	-	2	-	-	-
	抽油煙機保險菲士蘇 Fused spur for cooker hood	-	-	1	-	1	-	-	1	-	1	-	-	-
	蒸焗爐雙極開關掣 Double pole switch for combi-steam oven	-	-	1	-	1	-	-	1	-	1	-	-	-
	蒸焗爐接線座 Connection unit for combi-steam oven	-	-	1	-	1	-	-	1	-	1	-	-	-
	電磁爐雙極開關掣 Double pole switch for induction hob	-	-	1	-	1	-	-	1	-	1	-	-	-
	電磁爐接線座 Connection unit for induction hob	-	-	1	-	1	-	-	1	-	1	-	-	-
	燈位 Lighting point	-	-	2	-	2	-	-	2	-	2	-	-	-
	洗衣乾衣機來水位 Water inlet connection point for washer dryer	-	-	1	-	1	-	-	1	-	1	-	-	-
洗衣乾衣機去水位 Water outlet connection point for washer dryer	-	-	1	-	1	-	-	1	-	1	-	-	-	
廚房 Kitchen	電話接駁位 Telephone outlet	-	-	-	-	-	-	-	-	-	-	-	1	1
	雙位電插座 Twin socket outlet	2	2	-	2	-	2	2	-	2	-	2	2	2
	廚房電器單位電插座 Single socket outlet for kitchen appliances	5	3	-	2	-	5	3	-	2	-	5	5	5
	焗爐雙極開關掣 Double pole switch for oven	1	-	-	-	-	1	-	-	-	-	1	1	1
	焗爐接線座 Connection unit for oven	1	-	-	-	-	1	-	-	-	-	1	1	1
	電磁爐雙極開關掣 Double pole switch for induction hob	1	1	-	1	-	1	1	-	1	-	1	1	1
	電磁爐接線座 Connection unit for induction hob	1	1	-	1	-	1	1	-	1	-	1	1	1
	蒸焗爐雙極開關掣 Double pole switch for combi-steam oven	-	1	-	1	-	-	1	-	1	-	-	-	-
	蒸焗爐接線座 Connection unit for combi-steam oven	-	1	-	1	-	-	1	-	1	-	-	-	-
	抽油煙機保險菲士蘇 Fused spur for cooker hood	1	1	-	1	-	1	1	-	1	-	1	1	1
	煤氣熱水爐保險菲士蘇 Fused spur for gas water heater	1	1	-	1	-	1	1	-	1	-	1	1	1
	氣體煮食爐保險菲士蘇 Fused spur unit for gas hob	2	2	-	2	-	2	2	-	2	-	2	2	2
	燈掣 Lighting switch	-	-	-	-	-	-	-	-	-	-	-	-	1
	燈位 Lighting point	3	3	-	3	-	3	3	-	3	-	3	3	3
門鐘 Door bell	1	1	-	1	-	1	1	-	1	-	1	1	1	

備註:

1. 上表所顯示的“1, 2,”表示提供於該住宅物業內的裝置數量。
2. 上表“-”代表不適用。
3. 第1座 (1A及1B) 不設13樓、14樓及24樓，9樓為庇護層。
4. 第2座 (2A及2B) 不設13樓、14樓、24樓及34樓，9樓為庇護層。

Notes:

1. “1, 2,” as shown in the schedule above denotes the quantity of such provision(s) provided in the residential unit.
2. The symbol “-” as shown in the schedule above denotes “Not applicable”.
3. 13/F, 14/F and 24/F are omitted in Tower 1 (1A and 1B) and 9/F is refuge floor.
4. 13/F, 14/F, 24/F and 34/F are omitted in Tower 2 (2A and 2B) and 9/F is refuge floor.

住宅物業機電裝置數量說明表

Schedule of Mechanical & Electrical Provisions of Residential Properties

位置 Location	描述 Description	第1座 (1A) Tower 1 (1A)													
		5樓 5/F					6樓至8樓、10樓至12樓、15樓至23樓及 25樓至31樓 (27樓A單位除外) 6/F-8/F, 10/F-12/F, 15/F-23/F & 25/F-31/F (Except Unit A on 27/F)					27樓 27/F	32樓 32/F		
		A	B	C	D	E	A	B	C	D	E	A	A	B	
廚房 Kitchen	保安系統開關掣 Switch for security system	-	-	-	1	-	-	-	-	-	-	-	-	-	-
	保安系統閃燈警鐘 Audio visual security alarm	-	-	-	1	-	-	-	-	-	-	-	-	-	-
	保安系統保險菲士蘇 Fused spur unit for security system	-	-	-	1	-	-	-	-	-	-	-	-	-	-
	保安系統面板 Security system panel	-	-	-	1	-	-	-	-	-	-	-	-	-	-
	總電掣箱 Miniature circuit breakers board	-	-	-	1	-	-	-	-	1	-	-	-	-	-
	洗衣乾衣機來水位 Water inlet connection point for washer dryer	-	1	-	1	-	-	1	-	1	-	-	-	-	1
	洗衣乾衣機去水位 Water outlet connection point for washer dryer	-	1	-	1	-	-	1	-	1	-	-	-	-	1
	洗碗碟機來水位 Water inlet connection point for dishwasher	1	-	-	-	-	1	-	-	-	-	1	1	-	-
	洗碗碟機去水位 Water outlet connection point for dishwasher	1	-	-	-	-	1	-	-	-	-	1	1	-	-
	抽氣扇保險菲士蘇 Fused spur unit for exhaust fan	1	1	-	1	-	1	1	-	1	-	1	1	1	1
	空調開關掣 Switch for air-conditioner unit	1	-	-	-	-	1	-	-	-	-	1	1	1	1
熱水爐保險菲士蘇 Fused spur unit for gas water heater	-	1	-	1	-	-	1	-	1	-	-	1	1	1	
士多房 Store	調光系統 Dimmer system	-	-	-	-	-	-	-	-	-	-	-	-	-	1
	調光系統互聯網接駁位 Internet connection point for dimmer system	-	-	-	-	-	-	-	-	-	-	-	-	-	1
	調光系統單位電插座 Single socket outlet for dimmer system	-	-	-	-	-	-	-	-	-	-	-	-	-	1
	總電掣箱 Miniature circuit breakers board	1	1	-	-	-	1	1	-	-	-	1	-	1	1
	單位電插座 Single socket outlet	1	1	-	-	-	1	1	-	-	-	1	-	1	1
	燈掣 Lighting switch	2	1	-	-	-	2	1	-	-	-	2	-	2	2
	燈位 Lighting point	1	1	-	-	-	1	1	-	-	-	2	-	1	1
	抽氣扇開關掣 Exhaust fan switch	1	1	-	-	-	1	1	-	-	-	1	-	1	1
	乾衣機單位電插座 Single socket outlet for dryer	1	-	-	-	-	1	-	-	-	-	1	-	-	-
	洗衣機單位電插座 Single socket outlet for washer	1	-	-	-	-	1	-	-	-	-	1	-	-	-
	保安系統保險菲士蘇 Fused spur unit for security system	1	1	-	-	-	-	-	-	-	-	-	-	-	-
	保安系統面板 Security system panel	1	1	-	-	-	-	-	-	-	-	-	-	-	-
	保安系統開關掣 Switch for security system	1	1	-	-	-	-	-	-	-	-	-	-	-	-
保安系統閃燈警鐘 Audio visual security alarm	1	1	-	-	-	-	-	-	-	-	-	-	-	-	

備註：

1. 上表所顯示的“1, 2,”表示提供於該住宅物業內的裝置數量。
2. 上表“-”代表不適用。
3. 第1座 (1A及1B) 不設13樓、14樓及24樓，9樓為庇護層。
4. 第2座 (2A及2B) 不設13樓、14樓、24樓及34樓，9樓為庇護層。

Notes:

1. “1, 2,” as shown in the schedule above denotes the quantity of such provision(s) provided in the residential unit.
2. The symbol “-” as shown in the schedule above denotes “Not applicable”.
3. 13/F, 14/F and 24/F are omitted in Tower 1 (1A and 1B) and 9/F is refuge floor.
4. 13/F, 14/F, 24/F and 34/F are omitted in Tower 2 (2A and 2B) and 9/F is refuge floor.

住宅物業機電裝置數量說明表
Schedule of Mechanical & Electrical Provisions of Residential Properties

位置 Location	描述 Description	第1座 (1A) Tower 1 (1A)												
		5樓 5/F					6樓至8樓、10樓至12樓、15樓至23樓及 25樓至31樓 (27樓A單位除外) 6/F-8/F, 10/F-12/F, 15/F-23/F & 25/F-31/F (Except Unit A on 27/F)					27樓 27/F	32樓 32/F	
		A	B	C	D	E	A	B	C	D	E	A	A	B
士多房 Store	空調機開關掣 Switch for air-conditioner unit	1	1	-	-	-	1	1	-	-	-	1	-	1
	洗衣機來水位 Water inlet connection point for washer	1	-	-	-	-	1	-	-	-	-	1	-	-
	洗衣機去水位 Water outlet connection point for washer	1	-	-	-	-	1	-	-	-	-	1	-	-
士多房 1 Store 1	調光系統 Dimmer system	-	-	-	-	-	-	-	-	-	-	-	1	-
	調光系統互聯網接駁位 Internet connection point for dimmer system	-	-	-	-	-	-	-	-	-	-	-	1	-
	調光系統單位電插座 Single socket outlet for dimmer system	-	-	-	-	-	-	-	-	-	-	-	1	-
	總電掣箱 Miniature circuit breakers board	-	-	-	-	-	-	-	-	-	-	-	1	-
	單位電插座 Single socket outlet	-	-	-	-	-	-	-	-	-	-	-	1	-
	燈掣 Lighting switch	-	-	-	-	-	-	-	-	-	-	-	2	-
	燈位 Lighting point	-	-	-	-	-	-	-	-	-	-	-	1	-
	抽氣扇開關掣 Exhaust fan switch	-	-	-	-	-	-	-	-	-	-	-	1	-
	乾衣機單位電插座 Single socket outlet for dryer	-	-	-	-	-	-	-	-	-	-	-	1	-
	洗衣機單位電插座 Single socket outlet for washer	-	-	-	-	-	-	-	-	-	-	-	1	-
	空調機開關掣 Switch for air-conditioner unit	-	-	-	-	-	-	-	-	-	-	-	1	-
	洗衣機來水位 Water inlet connection point for washer	-	-	-	-	-	-	-	-	-	-	-	1	-
	洗衣機去水位 Water outlet connection point for washer	-	-	-	-	-	-	-	-	-	-	-	1	-
士多房 2 Store 2	燈掣 Lighting switch	-	-	-	-	-	-	-	-	-	-	-	1	-
	燈位 Lighting point	-	-	-	-	-	-	-	-	-	-	-	1	-
洗手間 Lavatory	燈位 Lighting point	1	1	-	-	-	1	1	-	-	-	1	1	1
	煤氣熱水爐溫度控制器 Towngas water heater temperature controller	1	1	-	-	-	1	1	-	-	-	1	1	1
	抽氣扇保險菲士蘇 Fused spur unit for exhaust fan	1	1	-	-	-	1	1	-	-	-	1	1	1

備註：

1. 上表所顯示的“1, 2,”表示提供於該住宅物業內的裝置數量。
2. 上表“-”代表不適用。
3. 第1座 (1A及1B) 不設13樓、14樓及24樓，9樓為庇護層。
4. 第2座 (2A及2B) 不設13樓、14樓、24樓及34樓，9樓為庇護層。

Notes:

1. “1, 2,” as shown in the schedule above denotes the quantity of such provision(s) provided in the residential unit.
2. The symbol “-” as shown in the schedule above denotes “Not applicable”.
3. 13/F, 14/F and 24/F are omitted in Tower 1 (1A and 1B) and 9/F is refuge floor.
4. 13/F, 14/F, 24/F and 34/F are omitted in Tower 2 (2A and 2B) and 9/F is refuge floor.

住宅物業機電裝置數量說明表

Schedule of Mechanical & Electrical Provisions of Residential Properties

位置 Location	描述 Description	第1座 (1A) Tower 1 (1A)												
		5樓 5/F					6樓至8樓、10樓至12樓、15樓至23樓及 25樓至31樓 (27樓A單位除外) 6/F-8/F, 10/F-12/F, 15/F-23/F & 25/F-31/F (Except Unit A on 27/F)					27樓 27/F	32樓 32/F	
		A	B	C	D	E	A	B	C	D	E	A	A	B
露台 Balcony	燈位 Lighting point	-	-	-	-	-	1	1	1	1	1	1	2	1
工作平台 Utility Platform	燈位 Lighting point	-	-	-	-	-	1	1	1	1	1	-	-	
平台 Flat Roof	燈位 Lighting point	-	-	-	-	-	-	-	-	-	-	8	9	
	防水單位電插座 Waterproof single socket outlet	-	-	-	-	-	-	-	-	-	-	1	2	
私人天台 Private Roof	防水單位電插座 Waterproof single socket outlet	-	-	-	-	-	-	-	-	-	-	2	2	
	室外空調機隔離開關掣 Isolator for outdoor air-conditioner unit	-	-	-	-	-	-	-	-	-	-	3	2	
	燈掣 Lighting switch	-	-	-	-	-	-	-	-	-	-	1	1	
	燈位 Lighting point	-	-	-	-	-	-	-	-	-	-	17	9	
	消防喉轆 Fire services hose reel	-	-	-	-	-	-	-	-	-	-	1	1	
	消防掣手 Fire services breakglass unit	-	-	-	-	-	-	-	-	-	-	1	1	
私人花園 Private Garden	消防警鐘 Fire services alarm bell	-	-	-	-	-	-	-	-	-	-	1	1	
	防水單位電插座 Waterproof single socket outlet	2	2	2	3	2	-	-	-	-	-	-	-	
	動作傳感器 Motion sensor	2	1	1	3	1	-	-	-	-	-	-	-	
	燈位 Lighting point	3	3	3	4	4	-	-	-	-	-	-	-	
	洗滌盆去水位 Water outlet connection point for sink	1	1	1	1	1	-	-	-	-	-	-	-	
洗滌盆來水位 Water inlet connection point for sink	1	1	1	1	1	-	-	-	-	-	-	-		
空調機平台 Air-Conditioner Platform	室外空調機隔離開關掣 Isolator for outdoor air-conditioner unit	-	-	-	-	-	3	3	2	1	2	3	-	-
鋼筋混凝土基座 Reinforced Concrete Plinth	室外空調機隔離開關掣 Isolator for outdoor air-conditioner unit	3	3	2	1	1	-	-	-	-	-	-	-	

備註：

1. 上表所顯示的“1, 2,”表示提供於該住宅物業內的裝置數量。
2. 上表“-”代表不適用。
3. 第1座 (1A及1B) 不設13樓、14樓及24樓，9樓為庇護層。
4. 第2座 (2A及2B) 不設13樓、14樓、24樓及34樓，9樓為庇護層。

Notes:

1. “1, 2,” as shown in the schedule above denotes the quantity of such provision(s) provided in the residential unit.
2. The symbol “-” as shown in the schedule above denotes “Not applicable”.
3. 13/F, 14/F and 24/F are omitted in Tower 1 (1A and 1B) and 9/F is refuge floor.
4. 13/F, 14/F, 24/F and 34/F are omitted in Tower 2 (2A and 2B) and 9/F is refuge floor.

住宅物業機電裝置數量說明表
Schedule of Mechanical & Electrical Provisions of Residential Properties

位置 Location	描述 Description	第1座(1B) Tower 1 (1B)														
		5樓 5/F						6樓至8樓、10樓至12樓、 15樓至23樓及25樓至31樓 6/F-8/F, 10/F-12/F, 15/F-23/F & 25/F-31/F						32樓 32/F		
		A	B	C	D	E	F	A	B	C	D	E	F	A	B	C
大門入口 Main Entrance	門鈴按鈕 Door bell push button	1	1	1	1	1	1	1	1	1	1	1	1	1	1	1
客廳/飯廳 Living Room / Dining Room	電視/電台天線接駁位 TV/FM outlet	2	2	2	2	2	2	2	2	2	2	2	2	2	2	2
	電話接駁位 Telephone outlet	2	2	2	2	2	2	2	2	2	2	2	2	2	2	2
	互聯網接駁位 Internet connection point	3	3	-	-	-	-	3	3	-	-	-	-	3	3	3
	雙位電插座 Twin socket outlet	3	3	2	2	2	2	3	3	2	2	2	2	5	3	3
	單位電插座 Single socket outlet	-	-	1	-	-	-	-	-	1	-	-	-	-	-	2
	單位電插座(連USB插座) Single socket outlet (with USB socket)	-	-	-	-	1	-	-	-	-	-	1	-	-	-	-
	空調機開關掣 Switch for air-conditioner unit	2	2	1	1	1	1	2	2	1	1	1	1	3	2	3
	電窗簾預留接駁位 Reserved connection point for electric curtain	1	-	-	-	-	-	1	-	-	-	-	-	2	1	1
	抽氣扇開關掣 Exhaust fan switch	2	2	2	-	-	-	2	2	2	-	-	-	2	2	2
	總電掣箱 Miniature circuit breakers board	-	-	-	-	1	-	-	-	-	-	1	-	-	-	-
	燈掣 Lighting switch	5	5	5	5	5	5	5	5	5	5	5	5	8	8	8
	燈位 Lighting point	7	4	3	4	4	4	7	4	3	4	4	4	7	6	11
	門鐘 Door bell	-	-	-	1	1	1	-	-	-	1	1	1	-	-	-
	保安系統保險非士蘇 Fused spur unit for security system	-	-	-	1	1	1	-	-	-	-	-	-	-	-	-
	保安系統面板 Security system panel	-	-	-	1	1	1	-	-	-	-	-	-	-	-	-
	保安系統閃燈警鐘 Audio visual security alarm	-	-	-	1	1	1	-	-	-	-	-	-	-	-	-
	保安系統開關掣 Switch for security system	-	-	-	1	1	1	-	-	-	-	-	-	-	-	-
	視像對講機 Video door phone	1	1	1	1	1	1	1	1	1	1	1	1	1	1	1
煙霧探測器及蜂鳴底座 Smoke detector with sounder base	-	-	-	1	1	1	-	-	-	1	1	1	-	-	-	
調光系統單位電插座 Single socket outlet for dimming system	-	-	-	-	-	-	-	-	-	-	-	-	1	1	1	

備註:

1. 上表所顯示的“1, 2,”表示提供於該住宅物業內的裝置數量。
2. 上表“-”代表不適用。
3. 第1座(1A及1B)不設13樓、14樓及24樓, 9樓為庇護層。
4. 第2座(2A及2B)不設13樓、14樓、24樓及34樓, 9樓為庇護層。

Notes:

1. “1, 2,” as shown in the schedule above denotes the quantity of such provision(s) provided in the residential unit.
2. The symbol “-” as shown in the schedule above denotes “Not applicable”.
3. 13/F, 14/F and 24/F are omitted in Tower 1 (1A and 1B) and 9/F is refuge floor.
4. 13/F, 14/F, 24/F and 34/F are omitted in Tower 2 (2A and 2B) and 9/F is refuge floor.

住宅物業機電裝置數量說明表
Schedule of Mechanical & Electrical Provisions of Residential Properties

位置 Location	描述 Description	第1座 (1B) Tower 1 (1B)														
		5樓 5/F						6樓至8樓、10樓至12樓、 15樓至23樓及25樓至31樓 6/F-8/F, 10/F-12/F, 15/F-23/F & 25/F-31/F						32樓 32/F		
		A	B	C	D	E	F	A	B	C	D	E	F	A	B	C
主人睡房 Master Bedroom	電視/電台天線接駁位 TV/FM outlet	1	1	1	1	1	1	1	1	1	1	1	1	1	1	1
	電話接駁位 Telephone outlet	1	1	1	1	1	1	1	1	1	1	1	1	1	1	1
	互聯網接駁位 Internet connection point	1	1	-	-	-	-	1	1	-	-	-	-	1	1	1
	單位電插座 Single socket outlet	3	3	2	2	2	2	3	3	2	2	2	2	3	3	4
	單位電插座 (連USB插座) Single socket outlet (with USB socket)	1	1	1	1	1	1	1	1	1	1	1	1	1	1	1
	空調機開關掣 Switch for air-conditioner unit	1	1	1	1	1	1	1	1	1	1	1	1	2	1	1
	電窗簾預留接駁位 Reserved connection point for electric curtain	1	-	-	-	-	-	1	-	-	-	-	-	1	1	1
	燈掣 Lighting switch	2	2	2	1	1	1	2	3	3	2	1	2	2	3	2
燈位 Lighting point	2	1	1	1	1	1	2	1	1	1	1	1	2	1	1	
睡房 Bedroom	電視/電台天線接駁位 TV/FM outlet	-	-	1	1	1	1	-	-	1	1	1	1	-	-	-
	電話接駁位 Telephone outlet	-	-	1	1	1	1	-	-	1	1	1	1	-	-	-
	單位電插座 Single socket outlet	-	-	1	1	1	1	-	-	1	1	1	1	-	-	-
	單位電插座 (連USB插座) Single socket outlet (with USB socket)	-	-	1	1	1	1	-	-	1	1	1	1	-	-	-
	空調機開關掣 Switch for air-conditioner unit	-	-	1	1	1	1	-	-	1	1	1	1	-	-	-
	燈掣 Lighting switch	-	-	1	1	1	1	-	-	1	1	1	1	-	-	-
	燈位 Lighting point	-	-	1	1	1	1	-	-	1	1	1	1	-	-	-
睡房1 Bedroom 1	電視/電台天線接駁位 TV/FM outlet	1	1	-	-	-	-	1	1	-	-	-	-	1	1	1
	電話接駁位 Telephone outlet	1	1	-	-	-	-	1	1	-	-	-	-	1	1	1
	互聯網接駁位 Internet connection point	1	1	-	-	-	-	1	1	-	-	-	-	1	1	1
	單位電插座 Single socket outlet	1	1	-	-	-	-	1	1	-	-	-	-	3	1	1
	單位電插座 (連USB插座) Single socket outlet (with USB socket)	1	1	-	-	-	-	1	1	-	-	-	-	1	1	1
	空調機開關掣 Switch for air-conditioner unit	1	1	-	-	-	-	1	1	-	-	-	-	1	1	1
	電窗簾預留接駁位 Reserved connection point for electric curtain	1	-	-	-	-	-	1	-	-	-	-	-	1	1	1
	燈掣 Lighting switch	2	1	-	-	-	-	2	1	-	-	-	-	3	1	1
	抽氣扇開關掣 Exhaust fan switch	1	-	-	-	-	-	1	-	-	-	-	-	1	-	-
燈位 Lighting point	1	1	-	-	-	-	1	1	-	-	-	-	1	1	1	

備註:

1. 上表所顯示的“1, 2,”表示提供於該住宅物業內的裝置數量。
2. 上表“-”代表不適用。
3. 第1座 (1A及1B) 不設13樓、14樓及24樓，9樓為庇護層。
4. 第2座 (2A及2B) 不設13樓、14樓、24樓及34樓，9樓為庇護層。

Notes:

1. “1, 2,” as shown in the schedule above denotes the quantity of such provision(s) provided in the residential unit.
2. The symbol “-” as shown in the schedule above denotes “Not applicable”.
3. 13/F, 14/F and 24/F are omitted in Tower 1 (1A and 1B) and 9/F is refuge floor.
4. 13/F, 14/F, 24/F and 34/F are omitted in Tower 2 (2A and 2B) and 9/F is refuge floor.

住宅物業機電裝置數量說明表

Schedule of Mechanical & Electrical Provisions of Residential Properties

位置 Location	描述 Description	第1座 (1B) Tower 1 (1B)														
		5樓 5/F						6樓至8樓、10樓至12樓、 15樓至23樓及25樓至31樓 6/F-8/F, 10/F-12/F, 15/F-23/F & 25/F-31/F						32樓 32/F		
		A	B	C	D	E	F	A	B	C	D	E	F	A	B	C
睡房2 Bedroom 2	電視/電台天線接駁位 TV/FM outlet	1	1	-	-	-	-	1	1	-	-	-	-	1	1	1
	電話接駁位 Telephone outlet	1	1	-	-	-	-	1	1	-	-	-	-	1	1	1
	互聯網接駁位 Internet connection point	1	1	-	-	-	-	1	1	-	-	-	-	1	1	1
	單位電插座 Single socket outlet	1	1	-	-	-	-	1	1	-	-	-	-	1	1	1
	單位電插座 (連USB插座) Single socket outlet (with USB socket)	1	1	-	-	-	-	1	1	-	-	-	-	1	1	1
	空調機開關掣 Switch for air-conditioner unit	1	1	-	-	-	-	1	1	-	-	-	-	1	1	1
	電窗簾預留接駁位 Reserved connection point for electric curtain	1	-	-	-	-	-	1	-	-	-	-	-	1	1	1
	燈掣 Lighting switch	1	1	-	-	-	-	1	1	-	-	-	-	2	1	1
	抽氣扇開關掣 Exhaust fan switch	-	-	-	-	-	-	-	-	-	-	-	-	1	-	-
燈位 Lighting point	1	1	-	-	-	-	1	1	-	-	-	-	1	1	1	
睡房3 Bedroom 3	電視/電台天線接駁位 TV/FM outlet	1	-	-	-	-	-	1	-	-	-	-	-	1	-	-
	電話接駁位 Telephone outlet	1	-	-	-	-	-	1	-	-	-	-	-	1	-	-
	互聯網接駁位 Internet connection point	1	-	-	-	-	-	1	-	-	-	-	-	1	-	-
	單位電插座 Single socket outlet	1	-	-	-	-	-	1	-	-	-	-	-	1	-	-
	單位電插座 (連USB插座) Single socket outlet (with USB socket)	1	-	-	-	-	-	1	-	-	-	-	-	1	-	-
	空調機開關掣 Switch for air-conditioner unit	1	-	-	-	-	-	1	-	-	-	-	-	1	-	-
	電窗簾預留接駁位 Reserved connection point for electric curtain	1	-	-	-	-	-	1	-	-	-	-	-	1	-	-
	燈掣 Lighting switch	1	-	-	-	-	-	1	-	-	-	-	-	1	-	-
燈位 Lighting point	1	-	-	-	-	-	1	-	-	-	-	-	1	-	-	
主人浴室 Master Bathroom	單位電插座 (鏡櫃內) Single socket outlet (at mirror cabinet)	1	1	1	-	-	-	1	1	1	-	-	-	1	1	1
	煤氣熱水爐溫度控制器 Towngas water heater temperature controller	-	-	1	-	-	-	-	-	1	-	-	-	-	-	-
	燈位 Lighting point	5	3	3	-	-	-	5	3	3	-	-	-	6	3	3
	換氣暖風機隔離開關掣 Isolator for thermo ventilator	1	1	1	-	-	-	1	1	1	-	-	-	1	1	1
	電熱水爐隔離開關掣 Isolator for electric water heater	1	1	-	-	-	-	1	1	-	-	-	-	1	1	1
	鏡子加熱器保險非士蘇 Fused spur unit for mirror heater	-	-	-	-	-	-	-	-	-	-	-	-	1	1	1

備註:

1. 上表所顯示的“1, 2,”表示提供於該住宅物業內的裝置數量。
2. 上表“-”代表不適用。
3. 第1座 (1A及1B) 不設13樓、14樓及24樓，9樓為庇護層。
4. 第2座 (2A及2B) 不設13樓、14樓、24樓及34樓，9樓為庇護層。

Notes:

1. “1, 2,” as shown in the schedule above denotes the quantity of such provision(s) provided in the residential unit.
2. The symbol “-” as shown in the schedule above denotes “Not applicable”.
3. 13/F, 14/F and 24/F are omitted in Tower 1 (1A and 1B) and 9/F is refuge floor.
4. 13/F, 14/F, 24/F and 34/F are omitted in Tower 2 (2A and 2B) and 9/F is refuge floor.

住宅物業機電裝置數量說明表

Schedule of Mechanical & Electrical Provisions of Residential Properties

位置 Location	描述 Description	第1座 (1B) Tower 1 (1B)														
		5樓 5/F						6樓至8樓、10樓至12樓、 15樓至23樓及25樓至31樓 6/F-8/F, 10/F-12/F, 15/F-23/F & 25/F-31/F						32樓 32/F		
		A	B	C	D	E	F	A	B	C	D	E	F	A	B	C
浴室 Bathroom	單位電插座 (鏡櫃內) Single socket outlet (at mirror cabinet)	-	1	1	1	1	1	-	1	1	1	1	1	-	1	1
	煤氣熱水爐溫度控制器 Towngas water heater temperature controller	-	1	1	-	-	-	-	1	1	-	-	-	-	1	1
	燈位 Lighting point	-	3	3	3	3	3	-	3	3	3	3	3	-	3	3
	抽氣扇保險非士蘇 Fused spur unit for exhaust fan	-	1	1	-	-	-	-	1	1	-	-	-	-	1	1
	換氣暖風機隔離開關掣 Isolator for thermo ventilator	-	-	-	1	1	1	-	-	-	1	1	1	-	-	-
	電熱水爐隔離開關掣 Isolator for electric water heater	-	-	-	1	1	1	-	-	-	1	1	1	-	-	-
	鏡子加熱器保險非士蘇 Fused spur unit for mirror heater	-	-	-	-	-	-	-	-	-	-	-	-	-	1	1
浴室1 Bathroom 1	單位電插座 (鏡櫃內) Single socket outlet (at mirror cabinet)	1	-	-	-	-	-	1	-	-	-	-	-	1	-	-
	煤氣熱水爐溫度控制器 Towngas water heater temperature controller	1	-	-	-	-	-	1	-	-	-	-	-	1	-	-
	燈位 Lighting point	3	-	-	-	-	-	3	-	-	-	-	-	3	-	-
	鏡子加熱器保險非士蘇 Fused spur unit for mirror heater	-	-	-	-	-	-	-	-	-	-	-	-	1	-	-
	抽氣扇保險非士蘇 Fused spur unit for exhaust fan	1	-	-	-	-	-	1	-	-	-	-	-	1	-	-
浴室2 Bathroom 2	單位電插座 (鏡櫃內) Single socket outlet (at mirror cabinet)	1	-	-	-	-	-	1	-	-	-	-	-	1	-	-
	煤氣熱水爐溫度控制器 Towngas water heater temperature controller	1	-	-	-	-	-	1	-	-	-	-	-	-	-	-
	燈位 Lighting point	3	-	-	-	-	-	3	-	-	-	-	-	3	-	-
	鏡子加熱器保險非士蘇 Fused spur unit for mirror heater	-	-	-	-	-	-	-	-	-	-	-	-	1	-	-
	抽氣扇保險非士蘇 Fused spur unit for exhaust fan	1	-	-	-	-	-	1	-	-	-	-	-	1	-	-
	電熱水爐隔離開關掣 Isolator for electric water heater	-	-	-	-	-	-	-	-	-	-	-	-	1	-	-
浴室3 Bathroom 3	單位電插座 Single socket outlet	-	-	-	-	-	-	-	-	-	-	-	-	1	-	-
	煤氣熱水爐溫度控制器 Towngas water heater temperature controller	-	-	-	-	-	-	-	-	-	-	-	-	1	-	-
	燈位 Lighting point	-	-	-	-	-	-	-	-	-	-	-	-	3	-	-
	鏡子加熱器保險非士蘇 Fused spur unit for mirror heater	-	-	-	-	-	-	-	-	-	-	-	-	1	-	-
	抽氣扇保險非士蘇 Fused spur unit for exhaust fan	-	-	-	-	-	-	-	-	-	-	-	-	1	-	-

備註：

1. 上表所顯示的“1, 2,”表示提供於該住宅物業內的裝置數量。
2. 上表“-”代表不適用。
3. 第1座 (1A及1B) 不設13樓、14樓及24樓，9樓為庇護層。
4. 第2座 (2A及2B) 不設13樓、14樓、24樓及34樓，9樓為庇護層。

Notes:

1. “1, 2,” as shown in the schedule above denotes the quantity of such provision(s) provided in the residential unit.
2. The symbol “-” as shown in the schedule above denotes “Not applicable”.
3. 13/F, 14/F and 24/F are omitted in Tower 1 (1A and 1B) and 9/F is refuge floor.
4. 13/F, 14/F, 24/F and 34/F are omitted in Tower 2 (2A and 2B) and 9/F is refuge floor.

住宅物業機電裝置數量說明表

Schedule of Mechanical & Electrical Provisions of Residential Properties

位置 Location	描述 Description	第1座 (1B) Tower 1 (1B)														
		5樓 5/F						6樓至8樓、10樓至12樓、 15樓至23樓及25樓至31樓 6/F-8/F, 10/F-12/F, 15/F-23/F & 25/F-31/F						32樓 32/F		
		A	B	C	D	E	F	A	B	C	D	E	F	A	B	C
開放式廚房 Open Kitchen	暗藏式灑水器 Concealed type sprinkler	-	-	-	1	1	1	-	-	-	1	1	1	-	-	-
	雙位電插座 Twin socket outlet	-	-	-	2	2	2	-	-	-	2	2	2	-	-	-
	廚房電器單位電插座 Single socket outlet for kitchen appliances	-	-	-	2	2	2	-	-	-	2	2	2	-	-	-
	抽油煙機保險非士蘇 Fused spur for cooker hood	-	-	-	1	1	1	-	-	-	1	1	1	-	-	-
	蒸焗爐雙極開關掣 Double pole switch for combi-steam oven	-	-	-	1	1	1	-	-	-	1	1	1	-	-	-
	蒸焗爐接線座 Connection unit for combi-steam oven	-	-	-	1	1	1	-	-	-	1	1	1	-	-	-
	電磁爐雙極開關掣 Double pole switch for induction hob	-	-	-	1	1	1	-	-	-	1	1	1	-	-	-
	電磁爐接線座 Connection unit for induction hob	-	-	-	1	1	1	-	-	-	1	1	1	-	-	-
	燈位 Lighting point	-	-	-	2	2	2	-	-	-	2	2	2	-	-	-
	總電掣箱 Miniature circuit breakers board	-	-	-	1	-	1	-	-	-	1	-	1	-	-	-
	洗衣乾衣機來水位 Water inlet connection point for washer dryer	-	-	-	1	1	1	-	-	-	1	1	1	-	-	-
	洗衣乾衣機去水位 Water outlet connection point for washer dryer	-	-	-	1	1	1	-	-	-	1	1	1	-	-	-
廚房 Kitchen	電話接駁位 Telephone outlet	-	-	-	-	-	-	-	-	-	-	-	-	1	1	1
	雙位電插座 Twin socket outlet	2	2	2	-	-	-	2	2	2	-	-	-	2	2	2
	廚房電器單位電插座 Single socket outlet for kitchen appliances	5	3	2	-	-	-	5	3	2	-	-	-	5	5	1
	焗爐雙極開關掣 Double pole switch for oven	1	-	-	-	-	-	1	-	-	-	-	-	1	1	-
	焗爐接線座 Connection unit for oven	1	-	-	-	-	-	1	-	-	-	-	-	1	1	-
	電磁爐雙極開關掣 Double pole switch for induction hob	1	1	1	-	-	-	1	1	1	-	-	-	1	1	1
	電磁爐接線座 Connection unit for induction hob	1	1	1	-	-	-	1	1	1	-	-	-	1	1	1
	蒸焗爐雙極開關掣 Double pole switch for combi-steam oven	-	1	1	-	-	-	-	1	1	-	-	-	-	-	1
	蒸焗爐接線座 Connection unit for combi-steam oven	-	1	1	-	-	-	-	1	1	-	-	-	-	-	1
抽油煙機保險非士蘇 Fused spur for cooker hood	1	1	1	-	-	-	1	1	1	-	-	-	1	1	1	

備註：

1. 上表所顯示的“1, 2,”表示提供於該住宅物業內的裝置數量。
2. 上表“-”代表不適用。
3. 第1座 (1A及1B) 不設13樓、14樓及24樓，9樓為庇護層。
4. 第2座 (2A及2B) 不設13樓、14樓、24樓及34樓，9樓為庇護層。

Notes:

1. “1, 2,” as shown in the schedule above denotes the quantity of such provision(s) provided in the residential unit.
2. The symbol “-” as shown in the schedule above denotes “Not applicable”.
3. 13/F, 14/F and 24/F are omitted in Tower 1 (1A and 1B) and 9/F is refuge floor.
4. 13/F, 14/F, 24/F and 34/F are omitted in Tower 2 (2A and 2B) and 9/F is refuge floor.

住宅物業機電裝置數量說明表

Schedule of Mechanical & Electrical Provisions of Residential Properties

位置 Location	描述 Description	第1座 (1B) Tower 1 (1B)														
		5樓 5/F						6樓至8樓、10樓至12樓、 15樓至23樓及25樓至31樓 6/F-8/F, 10/F-12/F, 15/F-23/F & 25/F-31/F						32樓 32/F		
		A	B	C	D	E	F	A	B	C	D	E	F	A	B	C
廚房 Kitchen	煤氣熱水爐保險非士蘇 Fused spur for gas water heater	1	1	1	-	-	-	1	1	1	-	-	-	1	1	1
	氣體煮食爐保險非士蘇 Fused spur unit for gas hob	2	2	1	-	-	-	2	2	1	-	-	-	2	2	2
	燈位 Lighting point	3	3	3	-	-	-	3	3	3	-	-	-	5	2	3
	門鐘 Door bell	1	1	1	-	-	-	1	1	1	-	-	-	1	1	1
	保安系統開關掣 Switch for security system	-	-	1	-	-	-	-	-	-	-	-	-	-	-	-
	保安系統閃燈警鐘 Audio visual security alarm	-	-	1	-	-	-	-	-	-	-	-	-	-	-	-
	保安系統保險非士蘇 Fused spur unit for security system	-	-	1	-	-	-	-	-	-	-	-	-	-	-	-
	保安系統面板 Security system panel	-	-	1	-	-	-	-	-	-	-	-	-	-	-	-
	總電掣箱 Miniature circuit breakers board	-	-	1	-	-	-	-	-	1	-	-	-	-	-	-
	洗衣乾衣機來水位 Water inlet connection point for washer dryer	-	1	1	-	-	-	-	1	1	-	-	-	-	1	-
	洗衣乾衣機去水位 Water outlet connection point for washer dryer	-	1	1	-	-	-	-	1	1	-	-	-	-	1	-
	洗碗碟機來水位 Water inlet connection point for dishwasher	1	-	-	-	-	-	1	-	-	-	-	-	1	-	-
	洗碗碟機去水位 Water outlet connection point for dishwasher	1	-	-	-	-	-	1	-	-	-	-	-	1	-	-
	抽氣扇保險非士蘇 Fused spur unit for exhaust fan	1	1	1	-	-	-	1	1	1	-	-	-	1	1	1
	空調開關掣 Switch for air-conditioner unit	-	-	-	-	-	-	-	-	-	-	-	-	1	1	1
熱水爐保險非士蘇 Fused spur unit for gas water heater	1	1	1	-	-	-	1	1	1	-	-	-	1	1	1	

備註：

1. 上表所顯示的“1, 2,”表示提供於該住宅物業內的裝置數量。
2. 上表“-”代表不適用。
3. 第1座 (1A及1B) 不設13樓、14樓及24樓，9樓為庇護層。
4. 第2座 (2A及2B) 不設13樓、14樓、24樓及34樓，9樓為庇護層。

Notes:

1. “1, 2,” as shown in the schedule above denotes the quantity of such provision(s) provided in the residential unit.
2. The symbol “-” as shown in the schedule above denotes “Not applicable”.
3. 13/F, 14/F and 24/F are omitted in Tower 1 (1A and 1B) and 9/F is refuge floor.
4. 13/F, 14/F, 24/F and 34/F are omitted in Tower 2 (2A and 2B) and 9/F is refuge floor.

住宅物業機電裝置數量說明表
Schedule of Mechanical & Electrical Provisions of Residential Properties

位置 Location	描述 Description	第1座 (1B) Tower 1 (1B)														
		5樓 5/F						6樓至8樓、10樓至12樓、 15樓至23樓及25樓至31樓 6/F-8/F, 10/F-12/F, 15/F-23/F & 25/F-31/F						32樓 32/F		
		A	B	C	D	E	F	A	B	C	D	E	F	A	B	C
士多房 Store	調光系統 Dimmer system	-	-	-	-	-	-	-	-	-	-	-	-	-	1	1
	調光系統互聯網接駁位 Internet connection point for dimmer system	-	-	-	-	-	-	-	-	-	-	-	-	-	1	1
	調光系統單位電插座 Single socket outlet for dimmer system	-	-	-	-	-	-	-	-	-	-	-	-	-	1	1
	總電掣箱 Miniature circuit breakers board	1	1	-	-	-	-	1	1	-	-	-	-	-	1	1
	單位電插座 Single socket outlet	1	1	-	-	-	-	1	1	-	-	-	-	-	-	1
	燈掣 Lighting switch	2	1	-	-	-	-	2	1	-	-	-	-	-	1	1
	燈位 Lighting point	1	1	-	-	-	-	1	1	-	-	-	-	-	1	1
	抽氣扇開關掣 Exhaust fan switch	1	1	-	-	-	-	1	1	-	-	-	-	-	1	1
	乾衣機單位電插座 Single socket outlet for dryer	1	-	-	-	-	-	1	-	-	-	-	-	-	-	-
	洗衣機單位電插座 Single socket outlet for washer	1	-	-	-	-	-	1	-	-	-	-	-	-	-	1
	保安系統保險非士蘇 Fused spur unit for security system	1	1	-	-	-	-	-	-	-	-	-	-	-	-	-
	保安系統面板 Security system panel	1	1	-	-	-	-	-	-	-	-	-	-	-	-	-
	保安系統開關掣 Switch for security system	1	1	-	-	-	-	-	-	-	-	-	-	-	-	-
	保安系統閃燈警鐘 Audio visual security alarm	1	1	-	-	-	-	-	-	-	-	-	-	-	-	-
	空調機開關掣 Switch for air-conditioner unit	1	1	-	-	-	-	1	1	-	-	-	-	-	1	1
	洗衣機來水位 Water inlet connection point for washer	1	-	-	-	-	-	1	-	-	-	-	-	-	-	1
	洗衣機去水位 Water outlet connection point for washer	1	-	-	-	-	-	1	-	-	-	-	-	-	-	1

備註：

1. 上表所顯示的“1, 2,”表示提供於該住宅物業內的裝置數量。
2. 上表“-”代表不適用。
3. 第1座 (1A及1B) 不設13樓、14樓及24樓，9樓為庇護層。
4. 第2座 (2A及2B) 不設13樓、14樓、24樓及34樓，9樓為庇護層。

Notes:

1. “1, 2,” as shown in the schedule above denotes the quantity of such provision(s) provided in the residential unit.
2. The symbol “-” as shown in the schedule above denotes “Not applicable”.
3. 13/F, 14/F and 24/F are omitted in Tower 1 (1A and 1B) and 9/F is refuge floor.
4. 13/F, 14/F, 24/F and 34/F are omitted in Tower 2 (2A and 2B) and 9/F is refuge floor.

住宅物業機電裝置數量說明表

Schedule of Mechanical & Electrical Provisions of Residential Properties

位置 Location	描述 Description	第1座 (1B) Tower 1 (1B)																
		5樓 5/F						6樓至8樓、10樓至12樓、 15樓至23樓及25樓至31樓 6/F-8/F, 10/F-12/F, 15/F-23/F & 25/F-31/F						32樓 32/F				
		A	B	C	D	E	F	A	B	C	D	E	F	A	B	C		
士多房1 Store 1	調光系統 Dimmer system	-	-	-	-	-	-	-	-	-	-	-	-	-	-	1	-	-
	調光系統互聯網接駁位 Internet connection point for dimmer system	-	-	-	-	-	-	-	-	-	-	-	-	-	-	1	-	-
	調光系統單位電插座 Single socket outlet for dimmer system	-	-	-	-	-	-	-	-	-	-	-	-	-	-	1	-	-
	總電掣箱 Miniature circuit breakers board	-	-	-	-	-	-	-	-	-	-	-	-	-	-	1	-	-
	燈掣 Lighting switch	-	-	-	-	-	-	-	-	-	-	-	-	-	-	2	-	-
	燈位 Lighting point	-	-	-	-	-	-	-	-	-	-	-	-	-	-	1	-	-
	抽氣扇開關掣 Exhaust fan switch	-	-	-	-	-	-	-	-	-	-	-	-	-	-	1	-	-
	空調機開關掣 Switch for air-conditioner unit	-	-	-	-	-	-	-	-	-	-	-	-	-	-	1	-	-
	洗衣機來水位 Water inlet connection point for washer	-	-	-	-	-	-	-	-	-	-	-	-	-	-	1	-	-
	洗衣機去水位 Water outlet connection point for washer	-	-	-	-	-	-	-	-	-	-	-	-	-	-	1	-	-
士多房2 Store 2	燈掣 Lighting switch	-	-	-	-	-	-	-	-	-	-	-	-	-	1	-	-	
	燈位 Lighting point	-	-	-	-	-	-	-	-	-	-	-	-	-	1	-	-	
洗手間 Lavatory	燈位 Lighting point	1	1	-	-	-	-	1	1	-	-	-	-	-	1	1	1	
	煤氣熱水爐溫度控制器 Towngas water heater temperature controller	1	1	-	-	-	-	1	1	-	-	-	-	-	1	-	1	
	抽氣扇保險非士蘇 Fused spur unit for exhaust fan	1	1	-	-	-	-	1	1	-	-	-	-	-	1	1	1	
露台 Balcony	燈位 Lighting point	-	-	-	-	-	-	1	1	1	1	1	1	1	2	1	1	
工作平台 Utility Platform	燈位 Lighting point	-	-	-	-	-	-	1	1	1	1	1	1	1	-	1	1	
平台 Flat Roof	燈位 Lighting point	-	-	-	-	-	-	-	-	-	-	-	-	-	11	-	-	
	防水單位電插座 Waterproof single socket outlet	-	-	-	-	-	-	-	-	-	-	-	-	-	1	-	-	

備註：

1. 上表所顯示的“1, 2,”表示提供於該住宅物業內的裝置數量。
2. 上表“-”代表不適用。
3. 第1座 (1A及1B) 不設13樓、14樓及24樓，9樓為庇護層。
4. 第2座 (2A及2B) 不設13樓、14樓、24樓及34樓，9樓為庇護層。

Notes:

1. “1, 2,” as shown in the schedule above denotes the quantity of such provision(s) provided in the residential unit.
2. The symbol “-” as shown in the schedule above denotes “Not applicable”.
3. 13/F, 14/F and 24/F are omitted in Tower 1 (1A and 1B) and 9/F is refuge floor.
4. 13/F, 14/F, 24/F and 34/F are omitted in Tower 2 (2A and 2B) and 9/F is refuge floor.

住宅物業機電裝置數量說明表
Schedule of Mechanical & Electrical Provisions of Residential Properties

位置 Location	描述 Description	第1座 (1B) Tower 1 (1B)															
		5樓 5/F						6樓至8樓、10樓至12樓、 15樓至23樓及25樓至31樓 6/F-8/F, 10/F-12/F, 15/F-23/F & 25/F-31/F						32樓 32/F			
		A	B	C	D	E	F	A	B	C	D	E	F	A	B	C	
私人天台 Private Roof	防水單位電插座 Waterproof single socket outlet	-	-	-	-	-	-	-	-	-	-	-	-	-	2	2	2
	室外空調機隔離開關掣 Isolator for outdoor air-conditioner unit	-	-	-	-	-	-	-	-	-	-	-	-	-	3	2	2
	燈掣 Lighting switch	-	-	-	-	-	-	-	-	-	-	-	-	-	1	1	1
	燈位 Lighting point	-	-	-	-	-	-	-	-	-	-	-	-	-	16	17	19
	消防喉轆 Fire services hose reel	-	-	-	-	-	-	-	-	-	-	-	-	-	1	1	1
	消防掣手 Fire services breakglass unit	-	-	-	-	-	-	-	-	-	-	-	-	-	1	1	1
	消防警鐘 Fire services alarm bell	-	-	-	-	-	-	-	-	-	-	-	-	-	1	1	1
私人花園 Private Garden	防水單位電插座 Waterproof single socket outlet	2	2	2	2	2	2	-	-	-	-	-	-	-	-	-	-
	動作傳感器 Motion sensor	2	1	1	1	2	1	-	-	-	-	-	-	-	-	-	-
	燈位 Lighting point	4	5	5	2	7	4	-	-	-	-	-	-	-	-	-	-
	洗滌盆去水位 Water outlet connection point for sink	1	1	1	1	1	1	-	-	-	-	-	-	-	-	-	-
	洗滌盆來水位 Water inlet connection point for sink	1	1	1	1	1	1	-	-	-	-	-	-	-	-	-	-
空調機平台 Air-Conditioner Platform	室外空調機隔離開關掣 Isolator for outdoor air-conditioner unit	-	-	-	-	-	-	4	3	2	2	2	2	-	-	-	
鋼筋混凝土基座 Reinforced Concrete Plinth	室外空調機隔離開關掣 Isolator for outdoor air-conditioner unit	4	3	1	2	2	1	-	-	-	-	-	-	-	-	-	

備註：

1. 上表所顯示的“1, 2,”表示提供於該住宅物業內的裝置數量。
2. 上表“-”代表不適用。
3. 第1座 (1A及1B) 不設13樓、14樓及24樓，9樓為庇護層。
4. 第2座 (2A及2B) 不設13樓、14樓、24樓及34樓，9樓為庇護層。

Notes:

1. “1, 2,” as shown in the schedule above denotes the quantity of such provision(s) provided in the residential unit.
2. The symbol “-” as shown in the schedule above denotes “Not applicable”.
3. 13/F, 14/F and 24/F are omitted in Tower 1 (1A and 1B) and 9/F is refuge floor.
4. 13/F, 14/F, 24/F and 34/F are omitted in Tower 2 (2A and 2B) and 9/F is refuge floor.

住宅物業機電裝置數量說明表
Schedule of Mechanical & Electrical Provisions of Residential Properties

位置 Location	描述 Description	第2座 (2A) Tower 2 (2A)														
		5樓 5/F						6樓至8樓、10樓至12樓、15樓至23樓、 25樓至33樓及35樓至37樓 6/F-8/F, 10/F-12/F, 15/F-23/F, 25/F-33/F & 35/F-37/F						38樓 38/F		
		A	B	C	D	E	F	A	B	C	D	E	F	A	B	C
大門入口 Main Entrance	門鈴按鈕 Door bell push button	1	1	1	1	1	1	1	1	1	1	1	1	1	1	1
客廳/飯廳 Living Room / Dining Room	電視/電台天線接駁位 TV/FM outlet	2	2	2	2	2	2	2	2	2	2	2	2	2	2	2
	電話接駁位 Telephone outlet	2	2	2	2	2	2	2	2	2	2	2	2	2	2	2
	互聯網接駁位 Internet connection point	3	3	3	3	-	-	3	3	3	3	-	-	3	3	3
	雙位電插座 Twin socket outlet	3	3	3	3	2	2	3	3	3	3	2	2	3	3	3
	單位電插座 Single socket outlet	-	-	-	-	-	1	-	-	-	-	-	1	-	1	-
	單位電插座 (連USB插座) Single socket outlet (with USB socket)	-	-	-	-	1	-	-	-	-	-	1	-	-	-	-
	空調機開關掣 Switch for air-conditioner unit	2	2	2	2	1	1	2	2	2	2	1	1	4	2	3
	電窗簾預留接駁位 Reserved connection point for electric curtain	-	-	-	-	-	-	-	-	-	-	-	-	3	3	1
	抽氣扇開關掣 Exhaust fan switch	2	2	2	2	-	1	2	2	2	2	-	1	2	1	2
	總電掣箱 Miniature circuit breakers board	-	-	-	-	1	-	-	-	-	-	1	-	-	-	-
	燈掣 Lighting switch	5	5	5	5	3	5	5	5	5	5	4	5	8	5	9
	燈位 Lighting point	5	4	4	5	2	4	5	4	4	5	2	4	13	8	10
	門鐘 Door bell	-	-	-	-	1	-	-	-	-	-	1	-	-	-	-
	視像對講機 Video door phone	1	1	1	1	1	1	1	1	1	1	1	1	1	1	1
煙霧探測器及蜂鳴底座 Smoke detector with sounder base	-	-	-	-	1	-	-	-	-	-	1	-	-	-	-	
調光系統單位電插座 Single socket outlet for dimming system	-	-	-	-	-	-	-	-	-	-	-	-	1	-	1	
走廊 Corridor	單位電插座 Single socket outlet	-	-	-	-	-	-	-	-	-	-	-	-	-	1	-
	燈掣 Lighting switch	-	-	-	-	-	-	-	-	-	-	-	-	-	3	-
	燈位 Lighting point	-	-	-	-	-	-	-	-	-	-	-	-	-	2	-
	抽氣扇開關掣 Exhaust fan switch	-	-	-	-	-	-	-	-	-	-	-	-	-	1	-
	調光系統單位電插座 Single socket outlet for dimming system	-	-	-	-	-	-	-	-	-	-	-	-	-	1	-

備註:

1. 上表所顯示的“1, 2,”表示提供於該住宅物業內的裝置數量。
2. 上表“-”代表不適用。
3. 第1座 (1A及1B) 不設13樓、14樓及24樓，9樓為庇護層。
4. 第2座 (2A及2B) 不設13樓、14樓、24樓及34樓，9樓為庇護層。

Notes:

1. “1, 2,” as shown in the schedule above denotes the quantity of such provision(s) provided in the residential unit.
2. The symbol “-” as shown in the schedule above denotes “Not applicable”.
3. 13/F, 14/F and 24/F are omitted in Tower 1 (1A and 1B) and 9/F is refuge floor.
4. 13/F, 14/F, 24/F and 34/F are omitted in Tower 2 (2A and 2B) and 9/F is refuge floor.

住宅物業機電裝置數量說明表
Schedule of Mechanical & Electrical Provisions of Residential Properties

位置 Location	描述 Description	第2座 (2A) Tower 2 (2A)														
		5樓 5/F						6樓至8樓、10樓至12樓、15樓至23樓、 25樓至33樓及35樓至37樓 6/F-8/F, 10/F-12/F, 15/F-23/F, 25/F-33/F & 35/F-37/F						38樓 38/F		
		A	B	C	D	E	F	A	B	C	D	E	F	A	B	C
主人睡房 Master Bedroom	電視/電台天線接駁位 TV/FM outlet	1	1	1	1	-	1	1	1	1	1	-	1	1	1	1
	電話接駁位 Telephone outlet	1	1	1	1	-	1	1	1	1	1	-	1	1	1	1
	互聯網接駁位 Internet connection point	1	1	1	1	-	-	1	1	1	1	-	-	1	1	1
	單位電插座 Single socket outlet	3	3	3	3	-	2	3	3	3	3	-	2	3	3	3
	單位電插座 (連USB插座) Single socket outlet (with USB socket)	1	1	1	1	-	1	1	1	1	1	-	1	1	1	1
	空調機開關掣 Switch for air-conditioner unit	1	1	1	1	-	1	1	1	1	1	-	1	2	2	2
	電窗簾預留接駁位 Reserved connection point for electric curtain	-	-	-	-	-	-	-	-	-	-	-	-	1	1	1
	燈掣 Lighting switch	2	2	2	2	-	1	3	3	3	3	-	1	3	3	2
燈位 Lighting point	1	1	1	1	-	1	1	1	1	1	-	1	1	2	1	
睡房 Bedroom	電視/電台天線接駁位 TV/FM outlet	-	-	-	-	1	1	-	-	-	-	1	1	-	-	-
	電話接駁位 Telephone outlet	-	-	-	-	1	1	-	-	-	-	1	1	-	-	-
	單位電插座 Single socket outlet	-	-	-	-	1	1	-	-	-	-	1	1	-	-	-
	單位電插座 (連USB插座) Single socket outlet (with USB socket)	-	-	-	-	1	1	-	-	-	-	1	1	-	-	-
	空調機開關掣 Switch for air-conditioner unit	-	-	-	-	1	1	-	-	-	-	1	1	-	-	-
	燈掣 Lighting switch	-	-	-	-	2	1	-	-	-	-	2	1	-	-	-
燈位 Lighting point	-	-	-	-	1	1	-	-	-	-	1	1	-	-	-	
睡房1 Bedroom 1	電視/電台天線接駁位 TV/FM outlet	1	1	1	1	-	-	1	1	1	1	-	-	1	1	1
	電話接駁位 Telephone outlet	1	1	1	1	-	-	1	1	1	1	-	-	1	1	1
	互聯網接駁位 Internet connection point	1	1	1	1	-	-	1	1	1	1	-	-	1	1	1
	單位電插座 Single socket outlet	1	1	1	1	-	-	1	1	1	1	-	-	1	2	1
	單位電插座 (連USB插座) Single socket outlet (with USB socket)	1	1	1	1	-	-	1	1	1	1	-	-	1	1	1
	空調機開關掣 Switch for air-conditioner unit	1	1	1	1	-	-	1	1	1	1	-	-	1	1	1
	電窗簾預留接駁位 Reserved connection point for electric curtain	-	-	-	-	-	-	-	-	-	-	-	-	1	1	1
	燈掣 Lighting switch	1	1	1	1	-	-	1	1	1	1	-	-	2	2	1
	抽氣扇開關掣 Exhaust fan switch	-	-	-	-	-	-	-	-	-	-	-	-	1	1	-
燈位 Lighting point	1	1	1	1	-	-	1	1	1	1	-	-	1	1	1	

備註:

1. 上表所顯示的“1, 2,”表示提供於該住宅物業內的裝置數量。
2. 上表“-”代表不適用。
3. 第1座 (1A及1B) 不設13樓、14樓及24樓，9樓為庇護層。
4. 第2座 (2A及2B) 不設13樓、14樓、24樓及34樓，9樓為庇護層。

Notes:

1. “1, 2,” as shown in the schedule above denotes the quantity of such provision(s) provided in the residential unit.
2. The symbol “-” as shown in the schedule above denotes “Not applicable”.
3. 13/F, 14/F and 24/F are omitted in Tower 1 (1A and 1B) and 9/F is refuge floor.
4. 13/F, 14/F, 24/F and 34/F are omitted in Tower 2 (2A and 2B) and 9/F is refuge floor.

住宅物業機電裝置數量說明表
Schedule of Mechanical & Electrical Provisions of Residential Properties

位置 Location	描述 Description	第2座 (2A) Tower 2 (2A)														
		5樓 5/F						6樓至8樓、10樓至12樓、15樓至23樓、 25樓至33樓及35樓至37樓 6/F-8/F, 10/F-12/F, 15/F-23/F, 25/F-33/F & 35/F-37/F						38樓 38/F		
		A	B	C	D	E	F	A	B	C	D	E	F	A	B	C
睡房2 Bedroom 2	電視/電台天線接駁位 TV/FM outlet	1	1	1	1	-	-	1	1	1	1	-	-	1	1	1
	電話接駁位 Telephone outlet	1	1	1	1	-	-	1	1	1	1	-	-	1	1	1
	互聯網接駁位 Internet connection point	1	1	1	1	-	-	1	1	1	1	-	-	1	1	1
	單位電插座 Single socket outlet	1	1	1	1	-	-	1	1	1	1	-	-	1	1	1
	單位電插座 (連USB插座) Single socket outlet (with USB socket)	1	1	1	1	-	-	1	1	1	1	-	-	1	1	1
	空調機開關掣 Switch for air-conditioner unit	1	1	1	1	-	-	1	1	1	1	-	-	1	1	1
	電窗簾預留接駁位 Reserved connection point for electric curtain	-	-	-	-	-	-	-	-	-	-	-	-	1	1	1
	燈掣 Lighting switch	1	1	1	1	-	-	1	1	1	1	-	-	1	1	1
	燈位 Lighting point	1	1	1	1	-	-	1	1	1	1	-	-	1	1	1
睡房3 Bedroom 3	電視/電台天線接駁位 TV/FM outlet	-	-	-	-	-	-	-	-	-	-	-	-	1	1	-
	電話接駁位 Telephone outlet	-	-	-	-	-	-	-	-	-	-	-	-	1	1	-
	互聯網接駁位 Internet connection point	-	-	-	-	-	-	-	-	-	-	-	-	1	1	-
	單位電插座 Single socket outlet	-	-	-	-	-	-	-	-	-	-	-	-	1	1	-
	單位電插座 (連USB插座) Single socket outlet (with USB socket)	-	-	-	-	-	-	-	-	-	-	-	-	1	1	-
	空調機開關掣 Switch for air-conditioner unit	-	-	-	-	-	-	-	-	-	-	-	-	1	1	-
	電窗簾預留接駁位 Reserved connection point for electric curtain	-	-	-	-	-	-	-	-	-	-	-	-	1	1	-
	燈掣 Lighting switch	-	-	-	-	-	-	-	-	-	-	-	-	2	1	-
燈位 Lighting point	-	-	-	-	-	-	-	-	-	-	-	-	1	1	-	

備註:

1. 上表所顯示的“1, 2,”表示提供於該住宅物業內的裝置數量。
2. 上表“-”代表不適用。
3. 第1座 (1A及1B) 不設13樓、14樓及24樓，9樓為庇護層。
4. 第2座 (2A及2B) 不設13樓、14樓、24樓及34樓，9樓為庇護層。

Notes:

1. “1, 2,” as shown in the schedule above denotes the quantity of such provision(s) provided in the residential unit.
2. The symbol “-” as shown in the schedule above denotes “Not applicable”.
3. 13/F, 14/F and 24/F are omitted in Tower 1 (1A and 1B) and 9/F is refuge floor.
4. 13/F, 14/F, 24/F and 34/F are omitted in Tower 2 (2A and 2B) and 9/F is refuge floor.

住宅物業機電裝置數量說明表

Schedule of Mechanical & Electrical Provisions of Residential Properties

位置 Location	描述 Description	第2座 (2A) Tower 2 (2A)														
		5樓 5/F						6樓至8樓、10樓至12樓、15樓至23樓、 25樓至33樓及35樓至37樓 6/F-8/F, 10/F-12/F, 15/F-23/F, 25/F-33/F & 35/F-37/F						38樓 38/F		
		A	B	C	D	E	F	A	B	C	D	E	F	A	B	C
主人浴室 Master Bathroom	單位電插座 (鏡櫃內) Single socket outlet (at mirror cabinet)	1	1	1	1	-	-	1	1	1	1	-	-	2	2	1
	燈位 Lighting point	3	3	3	3	-	-	3	3	3	3	-	-	4	6	3
	換氣暖風機隔離開關掣 Isolator for thermo ventilator	1	1	1	1	-	-	1	1	1	1	-	-	1	1	1
	電熱水爐隔離開關掣 Isolator for electric water heater	1	1	1	1	-	-	1	1	1	1	-	-	1	1	1
	鏡子加熱器保險非士蘇 Fused spur unit for mirror heater	-	-	-	-	-	-	-	-	-	-	-	-	1	1	1
浴室 Bathroom	單位電插座 (鏡櫃內) Single socket outlet (at mirror cabinet)	1	1	1	1	1	1	1	1	1	1	1	1	-	-	1
	煤氣熱水爐溫度控制器 Towngas water heater temperature controller	1	1	1	1	-	1	1	1	1	1	-	1	-	-	1
	燈位 Lighting point	3	3	3	3	3	3	3	3	3	3	3	3	-	-	3
	抽氣扇保險非士蘇 Fused spur unit for exhaust fan	1	1	1	1	-	-	1	1	1	1	-	-	-	-	1
	換氣暖風機隔離開關掣 Isolator for thermo ventilator	-	-	-	-	1	1	-	-	-	-	1	1	-	-	-
	電熱水爐隔離開關掣 Isolator for electric water heater	-	-	-	-	1	-	-	-	-	-	1	-	-	-	-
	鏡子加熱器保險非士蘇 Fused spur unit for mirror heater	-	-	-	-	-	-	-	-	-	-	-	-	-	-	1
浴室1 Bathroom 1	單位電插座 (鏡櫃內) Single socket outlet (at mirror cabinet)	-	-	-	-	-	-	-	-	-	-	-	-	1	1	-
	煤氣熱水爐溫度控制器 Towngas water heater temperature controller	-	-	-	-	-	-	-	-	-	-	-	-	1	1	-
	燈位 Lighting point	-	-	-	-	-	-	-	-	-	-	-	-	3	3	-
	鏡子加熱器保險非士蘇 Fused spur unit for mirror heater	-	-	-	-	-	-	-	-	-	-	-	-	1	1	-
	抽氣扇保險非士蘇 Fused spur unit for exhaust fan	-	-	-	-	-	-	-	-	-	-	-	-	1	1	-
浴室2 Bathroom 2	單位電插座 (鏡櫃內) Single socket outlet (at mirror cabinet)	-	-	-	-	-	-	-	-	-	-	-	-	1	1	-
	煤氣熱水爐溫度控制器 Towngas water heater temperature controller	-	-	-	-	-	-	-	-	-	-	-	-	1	1	-
	燈位 Lighting point	-	-	-	-	-	-	-	-	-	-	-	-	3	3	-
	鏡子加熱器保險非士蘇 Fused spur unit for mirror heater	-	-	-	-	-	-	-	-	-	-	-	-	1	1	-
	抽氣扇保險非士蘇 Fused spur unit for exhaust fan	-	-	-	-	-	-	-	-	-	-	-	-	1	1	-

備註:

1. 上表所顯示的“1, 2,”表示提供於該住宅物業內的裝置數量。
2. 上表“-”代表不適用。
3. 第1座 (1A及1B) 不設13樓、14樓及24樓，9樓為庇護層。
4. 第2座 (2A及2B) 不設13樓、14樓、24樓及34樓，9樓為庇護層。

Notes:

1. “1, 2,” as shown in the schedule above denotes the quantity of such provision(s) provided in the residential unit.
2. The symbol “-” as shown in the schedule above denotes “Not applicable”.
3. 13/F, 14/F and 24/F are omitted in Tower 1 (1A and 1B) and 9/F is refuge floor.
4. 13/F, 14/F, 24/F and 34/F are omitted in Tower 2 (2A and 2B) and 9/F is refuge floor.

住宅物業機電裝置數量說明表

Schedule of Mechanical & Electrical Provisions of Residential Properties

位置 Location	描述 Description	第2座 (2A) Tower 2 (2A)														
		5樓 5/F						6樓至8樓、10樓至12樓、15樓至23樓、 25樓至33樓及35樓至37樓 6/F-8/F, 10/F-12/F, 15/F-23/F, 25/F-33/F & 35/F-37/F						38樓 38/F		
		A	B	C	D	E	F	A	B	C	D	E	F	A	B	C
開放式廚房 Open Kitchen	暗藏式灑水器 Concealed type sprinkler	-	-	-	-	1	-	-	-	-	-	1	-	-	-	-
	雙位電插座 Twin socket outlet	-	-	-	-	2	-	-	-	-	-	2	-	-	-	-
	廚房電器單位電插座 Single socket outlet for kitchen appliances	-	-	-	-	2	-	-	-	-	-	2	-	-	-	-
	抽油煙機保險非士蘇 Fused spur for cooker hood	-	-	-	-	1	-	-	-	-	-	1	-	-	-	-
	蒸焗爐雙極開關掣 Double pole switch for combi-steam oven	-	-	-	-	1	-	-	-	-	-	1	-	-	-	-
	電磁爐雙極開關掣 Double pole switch for induction hob	-	-	-	-	1	-	-	-	-	-	1	-	-	-	-
	燈位 Lighting point	-	-	-	-	2	-	-	-	-	-	2	-	-	-	-
	洗衣乾衣機來水位 Water inlet connection point for washer dryer	-	-	-	-	1	-	-	-	-	-	1	-	-	-	-
	洗衣乾衣機去水位 Water outlet connection point for washer dryer	-	-	-	-	1	-	-	-	-	-	1	-	-	-	-
廚房 Kitchen	雙位電插座 Twin socket outlet	2	2	2	2	-	2	2	2	2	2	-	2	2	2	2
	廚房電器單位電插座 Single socket outlet for kitchen appliances	3	2	2	3	-	2	3	2	2	3	-	2	6	5	5
	焗爐雙極開關掣 Double pole switch for oven	-	-	-	-	-	-	-	-	-	-	-	-	1	1	1
	焗爐接線座 Connection unit for oven	-	-	-	-	-	-	-	-	-	-	-	-	1	1	1
	電磁爐雙極開關掣 Double pole switch for induction hob	1	1	1	1	-	1	1	1	1	1	-	1	1	1	1
	電磁爐接線座 Connection unit for induction hob	1	1	1	1	-	1	1	1	1	1	-	1	1	1	1
	蒸焗爐雙極開關掣 Double pole switch for combi-steam oven	1	1	1	1	-	1	1	1	1	1	-	1	-	-	-
	蒸焗爐接線座 Connection unit for combi-steam oven	1	1	1	1	-	1	1	1	1	1	-	1	-	-	-
	抽油煙機保險非士蘇 Fused spur for cooker hood	1	1	1	1	-	1	1	1	1	1	-	1	1	1	1
	煤氣熱水爐保險非士蘇 Fused spur for gas water heater	1	1	1	1	-	1	1	1	1	1	-	1	1	1	1
	氣體煮食爐保險非士蘇 Fused spur unit for gas hob	2	2	2	2	-	1	2	2	2	2	-	1	2	2	2
	燈位 Lighting point	3	3	3	3	-	3	3	3	3	3	-	3	3	3	3
	門鐘 Door bell	1	1	1	1	-	1	1	1	1	1	-	1	1	1	1
	保安系統開關掣 Switch for security system	-	-	-	-	-	1	-	-	-	-	-	-	-	-	-
	保安系統閃燈警鐘 Audio visual security alarm	-	-	-	-	-	1	-	-	-	-	-	-	-	-	-
	保安系統保險非士蘇 Fused spur unit for security system	-	-	-	-	-	1	-	-	-	-	-	-	-	-	-
保安系統面板 Security system panel	-	-	-	-	-	1	-	-	-	-	-	-	-	-	-	

備註：

1. 上表所顯示的“1, 2,”表示提供於該住宅物業內的裝置數量。
2. 上表“-”代表不適用。
3. 第1座 (1A及1B) 不設13樓、14樓及24樓，9樓為庇護層。
4. 第2座 (2A及2B) 不設13樓、14樓、24樓及34樓，9樓為庇護層。

Notes:

1. “1, 2,” as shown in the schedule above denotes the quantity of such provision(s) provided in the residential unit.
2. The symbol “-” as shown in the schedule above denotes “Not applicable”.
3. 13/F, 14/F and 24/F are omitted in Tower 1 (1A and 1B) and 9/F is refuge floor.
4. 13/F, 14/F, 24/F and 34/F are omitted in Tower 2 (2A and 2B) and 9/F is refuge floor.

住宅物業機電裝置數量說明表
Schedule of Mechanical & Electrical Provisions of Residential Properties

位置 Location	描述 Description	第2座 (2A) Tower 2 (2A)														
		5樓 5/F						6樓至8樓、10樓至12樓、15樓至23樓、 25樓至33樓及35樓至37樓 6/F-8/F, 10/F-12/F, 15/F-23/F, 25/F-33/F & 35/F-37/F						38樓 38/F		
		A	B	C	D	E	F	A	B	C	D	E	F	A	B	C
廚房 Kitchen	總電掣箱 Miniature circuit breakers board	-	-	-	-	-	1	-	-	-	-	-	1	-	-	-
	洗衣乾衣機來水位 Water inlet connection point for washer dryer	1	1	1	1	-	1	1	1	1	1	-	1	1	-	1
	洗衣乾衣機去水位 Water outlet connection point for washer dryer	1	1	1	1	-	1	1	1	1	1	-	1	1	-	1
	洗碗碟機來水位 Water inlet connection point for dishwasher	-	-	-	-	-	-	-	-	-	-	-	-	1	1	-
	洗碗碟機去水位 Water outlet connection point for dishwasher	-	-	-	-	-	-	-	-	-	-	-	-	1	1	-
	抽氣扇保險非士蘇 Fused spur unit for exhaust fan	1	1	1	1	-	1	1	1	1	1	-	1	1	1	1
	空調開關掣 Switch for air-conditioner unit	-	-	-	-	-	-	-	-	-	-	-	-	1	1	1
	熱水爐保險非士蘇 Fused spur unit for gas water heater	1	1	1	1	-	1	1	1	1	1	-	1	1	1	1
	電話接駁位 Telephone outlet	-	-	-	-	-	-	-	-	-	-	-	-	1	1	1
士多房 Store	調光系統 Dimmer system	-	-	-	-	-	-	-	-	-	-	-	-	1	-	-
	調光系統互聯網接駁位 Internet connection point for dimmer system	-	-	-	-	-	-	-	-	-	-	-	-	1	-	-
	調光系統單位電插座 Single socket outlet for dimmer system	-	-	-	-	-	-	-	-	-	-	-	-	1	-	-
	總電掣箱 Miniature circuit breakers board	1	1	1	1	-	-	1	1	1	1	-	-	1	-	-
	單位電插座 Single socket outlet	1	1	1	1	-	-	1	1	1	1	-	-	1	-	-
	燈掣 Lighting switch	1	1	2	1	-	-	1	1	2	1	-	-	1	-	-
	燈位 Lighting point	1	1	1	1	-	-	1	1	1	1	-	-	1	-	-
	抽氣扇開關掣 Exhaust fan switch	1	1	1	1	-	-	1	1	1	1	-	-	1	-	-
	保安系統保險非士蘇 Fused spur unit for security system	1	1	1	1	-	-	-	-	-	-	-	-	-	-	-
	保安系統面板 Security system panel	1	1	1	1	-	-	-	-	-	-	-	-	-	-	-
	保安系統開關掣 Local Switch for security system	1	1	1	1	-	-	-	-	-	-	-	-	-	-	-
	保安系統閃燈警鐘 Audio visual security alarm	1	1	1	1	-	-	-	-	-	-	-	-	-	-	-
空調機開關掣 Switch for air-conditioner unit	1	1	1	1	-	-	1	1	1	1	-	-	1	-	-	

備註：

1. 上表所顯示的“1, 2,”表示提供於該住宅物業內的裝置數量。
2. 上表“-”代表不適用。
3. 第1座 (1A及1B) 不設13樓、14樓及24樓，9樓為庇護層。
4. 第2座 (2A及2B) 不設13樓、14樓、24樓及34樓，9樓為庇護層。

Notes:

1. “1, 2,” as shown in the schedule above denotes the quantity of such provision(s) provided in the residential unit.
2. The symbol “-” as shown in the schedule above denotes “Not applicable”.
3. 13/F, 14/F and 24/F are omitted in Tower 1 (1A and 1B) and 9/F is refuge floor.
4. 13/F, 14/F, 24/F and 34/F are omitted in Tower 2 (2A and 2B) and 9/F is refuge floor.

住宅物業機電裝置數量說明表
Schedule of Mechanical & Electrical Provisions of Residential Properties

位置 Location	描述 Description	第2座 (2A) Tower 2 (2A)														
		5樓 5/F						6樓至8樓、10樓至12樓、15樓至23樓、 25樓至33樓及35樓至37樓 6/F-8/F, 10/F-12/F, 15/F-23/F, 25/F-33/F & 35/F-37/F						38樓 38/F		
		A	B	C	D	E	F	A	B	C	D	E	F	A	B	C
士多房1 Store 1	調光系統 Dimmer system	-	-	-	-	-	-	-	-	-	-	-	-	-	1	1
	調光系統互聯網接駁位 Internet connection point for dimmer system	-	-	-	-	-	-	-	-	-	-	-	-	-	1	1
	調光系統單位電插座 Single socket outlet for dimmer system	-	-	-	-	-	-	-	-	-	-	-	-	-	1	1
	總電掣箱 Miniature circuit breakers board	-	-	-	-	-	-	-	-	-	-	-	-	-	1	1
	單位電插座 Single socket outlet	-	-	-	-	-	-	-	-	-	-	-	-	-	2	1
	燈掣 Lighting switch	-	-	-	-	-	-	-	-	-	-	-	-	-	1	2
	燈位 Lighting point	-	-	-	-	-	-	-	-	-	-	-	-	-	1	1
	抽氣扇開關掣 Exhaust fan switch	-	-	-	-	-	-	-	-	-	-	-	-	-	1	1
	空調機開關掣 Switch for air-conditioner unit	-	-	-	-	-	-	-	-	-	-	-	-	-	1	1
	洗衣機來水位 Water inlet connection point for washer	-	-	-	-	-	-	-	-	-	-	-	-	-	1	-
洗衣機去水位 Water outlet connection point for washer	-	-	-	-	-	-	-	-	-	-	-	-	-	1	-	
士多房2 Store 2	燈掣 Lighting switch	-	-	-	-	-	-	-	-	-	-	-	-	-	1	1
	燈位 Lighting point	-	-	-	-	-	-	-	-	-	-	-	-	-	1	1
洗手間 Lavatory	燈位 Lighting point	1	1	1	1	-	-	1	1	1	1	-	-	1	1	1
	煤氣熱水爐溫度控制器 Towngas water heater temperature controller	1	1	1	1	-	-	1	1	1	1	-	-	1	1	1
	抽氣扇保險非士蘇 Fused spur unit for exhaust fan	1	1	1	1	-	-	1	1	1	1	-	-	-	1	1
露台 Balcony	燈位 Lighting point	-	-	-	-	-	-	1	1	1	1	1	1	1	1	1
工作平台 Utility Platform	燈位 Lighting point	-	-	-	-	-	-	1	1	1	1	-	1	-	-	-

備註:

1. 上表所顯示的“1, 2,”表示提供於該住宅物業內的裝置數量。
2. 上表“-”代表不適用。
3. 第1座 (1A及1B) 不設13樓、14樓及24樓，9樓為庇護層。
4. 第2座 (2A及2B) 不設13樓、14樓、24樓及34樓，9樓為庇護層。

Notes:

1. “1, 2,” as shown in the schedule above denotes the quantity of such provision(s) provided in the residential unit.
2. The symbol “-” as shown in the schedule above denotes “Not applicable”.
3. 13/F, 14/F and 24/F are omitted in Tower 1 (1A and 1B) and 9/F is refuge floor.
4. 13/F, 14/F, 24/F and 34/F are omitted in Tower 2 (2A and 2B) and 9/F is refuge floor.

住宅物業機電裝置數量說明表

Schedule of Mechanical & Electrical Provisions of Residential Properties

位置 Location	描述 Description	第2座 (2A) Tower 2 (2A)														
		5樓 5/F						6樓至8樓、10樓至12樓、15樓至23樓、 25樓至33樓及35樓至37樓 6/F-8/F, 10/F-12/F, 15/F-23/F, 25/F-33/F & 35/F-37/F						38樓 38/F		
		A	B	C	D	E	F	A	B	C	D	E	F	A	B	C
平台 Flat Roof	燈位 Lighting point	-	-	-	-	-	-	-	-	-	-	-	-	2	2	1
私人天台 Private Roof	防水單位電插座 Waterproof single socket outlet	-	-	-	-	-	-	-	-	-	-	-	-	2	2	2
	室外空調機隔離開關掣 Isolator for outdoor air-conditioner unit	-	-	-	-	-	-	-	-	-	-	-	-	3	2	2
	燈掣 Lighting switch	-	-	-	-	-	-	-	-	-	-	-	-	1	1	1
	燈位 Lighting point	-	-	-	-	-	-	-	-	-	-	-	-	21	19	13
	消防喉轆 Fire services hose reel	-	-	-	-	-	-	-	-	-	-	-	-	1	1	1
	消防掣手 Fire services breakglass unit	-	-	-	-	-	-	-	-	-	-	-	-	1	1	1
	消防警鐘 Fire services alarm bell	-	-	-	-	-	-	-	-	-	-	-	-	1	1	1
私人花園 Private Garden	防水單位電插座 Waterproof single socket outlet	2	2	3	3	-	2	-	-	-	-	-	-	-	-	-
	動作傳感器 Motion sensor	3	1	2	2	-	1	-	-	-	-	-	-	-	-	-
	燈位 Lighting point	5	4	5	7	-	1	-	-	-	-	-	-	-	-	-
	洗滌盆去水位 Water outlet connection point for sink	1	1	1	1	-	-	-	-	-	-	-	-	-	-	-
	洗滌盆來水位 Water inlet connection point for sink	1	1	1	1	-	-	-	-	-	-	-	-	-	-	-
空調機平台 Air-Conditioner Platform	室外空調機隔離開關掣 Isolator for outdoor air-conditioner unit	-	-	-	-	-	-	2	3	3	3	1	2	-	-	-
鋼筋混凝土基座 Reinforced Concrete Plinth	室外空調機隔離開關掣 Isolator for outdoor air-conditioner unit	2	3	1	3	1	2	-	-	-	-	-	-	-	-	-

備註：

1. 上表所顯示的“1, 2, ……”表示提供於該住宅物業內的裝置數量。
2. 上表“-”代表不適用。
3. 第1座 (1A及1B) 不設13樓、14樓及24樓，9樓為庇護層。
4. 第2座 (2A及2B) 不設13樓、14樓、24樓及34樓，9樓為庇護層。

Notes:

1. “1, 2, ……” as shown in the schedule above denotes the quantity of such provision(s) provided in the residential unit.
2. The symbol “-” as shown in the schedule above denotes “Not applicable”.
3. 13/F, 14/F and 24/F are omitted in Tower 1 (1A and 1B) and 9/F is refuge floor.
4. 13/F, 14/F, 24/F and 34/F are omitted in Tower 2 (2A and 2B) and 9/F is refuge floor.

住宅物業機電裝置數量說明表

Schedule of Mechanical & Electrical Provisions of Residential Properties

位置 Location	描述 Description	第2座 (2B) Tower 2 (2B)																											
		5樓 5/F				6樓至8樓 6/F-8/F							10樓至12樓、15樓至23樓、 25樓至33樓及35樓至36樓 10/F-12/F, 15/F-23/F, 25/F-33/F & 35/F-36/F							37樓 37/F					37樓及38樓 (複式) 37/F & 38/F (Duplex)			38樓 38/F	
		A	B	C	G	A	B	C	D	E	F	G	A	B	C	E	F	G	B	C	E	F	G	A	B	C			
大門入口 Main Entrance	門鈴按鈕 Door bell push button	1	1	1	1	1	1	1	1	1	1	1	1	1	1	1	1	1	1	1	1	1	1	1	1	1	1	1	
客廳/飯廳 Living Room / Dining Room	電視/電台天線接駁位 TV/FM outlet	2	2	2	2	2	2	2	2	2	2	2	2	2	2	2	2	2	2	2	2	2	2	2	2	2	2	2	
	電話接駁位 Telephone outlet	2	2	2	2	2	2	2	2	2	2	2	2	2	2	2	2	2	2	2	2	2	2	2	2	2	2	2	
	互聯網接駁位 Internet connection point	-	-	-	-	-	-	-	-	-	-	-	-	3	-	-	-	-	3	-	-	-	3	-	-	3	3	3	
	雙位電插座 Twin socket outlet	2	2	2	2	2	2	2	2	2	2	2	2	3	2	2	2	2	3	2	2	2	2	3	2	2	3	3	
	單位電插座 Single socket outlet	1	1	-	-	1	1	-	-	1	-	-	1	1	-	1	-	1	-	1	-	-	1	-	1	6	1	-	
	單位電插座 (連USB插座) Single socket outlet (with USB socket)	-	-	-	-	-	-	-	1	-	1	-	-	-	-	1	-	-	-	-	-	1	-	-	-	-	-	-	
	空調機開關掣 Switch for air-conditioner unit	1	1	1	1	1	1	1	1	1	1	1	1	1	1	1	1	1	1	1	1	1	1	1	1	2	3	3	
	電窗簾預留接駁位 Reserved connection point for electric curtain	-	-	-	-	-	-	-	-	-	-	-	-	-	-	-	-	-	-	-	-	-	-	-	-	1	2	1	
	抽氣扇開關掣 Exhaust fan switch	2	1	-	-	2	1	-	-	1	-	-	2	1	2	1	-	1	2	1	-	-	1	2	1	1	2	2	
	總電掣箱 Miniature circuit breakers board	-	-	-	-	-	-	-	1	-	1	-	-	-	-	1	-	-	-	-	-	1	-	-	-	-	-	-	
	燈掣 Lighting switch	4	5	4	4	4	5	5	4	5	4	5	4	5	5	4	5	5	5	5	5	4	5	5	5	4	7	6	8
	燈位 Lighting point	2	3	4	4	2	3	4	3	3	2	4	2	4	4	3	2	4	4	4	3	2	4	4	3	2	35	11	10
	門鐘 Door bell	-	-	1	1	-	-	1	1	-	1	1	-	-	-	1	1	-	-	-	-	1	1	-	-	-	-	-	-
	視像對講機 Video door phone	1	1	1	1	1	1	1	1	1	1	1	1	1	1	1	1	1	1	1	1	1	1	1	1	1	1	1	
	煙霧探測器及蜂鳴底座 Smoke detector with sounder base	-	-	1	1	-	-	1	1	-	1	1	-	-	-	1	1	-	-	-	-	1	1	-	-	-	-	-	-
調光系統單位電插座 Single socket outlet for dimming system	-	-	-	-	-	-	-	-	-	-	-	-	-	-	-	-	-	-	-	-	-	-	-	-	2	1	1		
主人睡房 Master Bedroom	電視/電台天線接駁位 TV/FM outlet	1	1	1	1	1	1	1	-	1	-	1	1	1	1	-	1	1	1	1	-	1	1	1	1	1	1	1	
	電話接駁位 Telephone outlet	1	1	1	1	1	1	1	-	1	-	1	1	1	1	-	1	1	1	1	-	1	1	1	1	1	1	1	
	互聯網接駁位 Internet connection point	-	-	-	-	-	-	-	-	-	-	-	-	-	-	-	-	-	-	-	-	-	-	-	1	1	1		
	單位電插座 Single socket outlet	2	2	2	2	2	2	2	-	2	-	2	2	3	2	-	2	2	3	2	-	2	2	3	2	6	3	3	
	單位電插座 (連USB插座) Single socket outlet (with USB socket)	1	1	1	1	1	1	1	-	1	-	1	1	1	1	-	1	1	1	1	-	1	1	1	1	-	1	1	
	空調機開關掣 Switch for air-conditioner unit	1	1	1	1	1	1	1	-	1	-	1	1	1	1	-	1	1	1	1	-	1	1	1	1	1	2	1	
	電窗簾預留接駁位 Reserved connection point for electric curtain	-	-	-	-	-	-	-	-	-	-	-	-	-	-	-	-	-	-	-	-	-	-	-	1	1	1		
	燈掣 Lighting switch	2	1	1	1	2	2	2	-	2	-	2	2	3	2	-	2	2	3	2	-	2	2	3	2	5	2	2	
燈位 Lighting point	1	1	1	1	1	1	1	-	1	-	1	1	1	1	-	1	1	1	1	-	1	1	1	1	14	2	2		

備註:

1. 上表所顯示的“1, 2,”表示提供於該住宅物業內的裝置數量。
2. 上表“-”代表不適用。
3. 第1座 (1A及1B) 不設13樓、14樓及24樓，9樓為庇護層。
4. 第2座 (2A及2B) 不設13樓、14樓、24樓及34樓，9樓為庇護層。

Notes:

1. “1, 2,” as shown in the schedule above denotes the quantity of such provision(s) provided in the residential unit.
2. The symbol “-” as shown in the schedule above denotes “Not applicable”.
3. 13/F, 14/F and 24/F are omitted in Tower 1 (1A and 1B) and 9/F is refuge floor.
4. 13/F, 14/F, 24/F and 34/F are omitted in Tower 2 (2A and 2B) and 9/F is refuge floor.

住宅物業機電裝置數量說明表
Schedule of Mechanical & Electrical Provisions of Residential Properties

位置 Location	描述 Description	第2座 (2B) Tower 2 (2B)																												
		5樓 5/F				6樓至8樓 6/F-8/F								10樓至12樓、15樓至23樓、 25樓至33樓及35樓至36樓 10/F-12/F, 15/F-23/F, 25/F-33/F & 35/F-36/F							37樓 37/F					37樓及38樓 (複式) 37/F & 38/F (Duplex)			38樓 38/F	
		A	B	C	G	A	B	C	D	E	F	G	A	B	C	E	F	G	B	C	E	F	G	A	B	C				
睡房 Bedroom	電視/電台天線接駁位 TV/FM outlet	1	1	1	1	1	1	1	1	1	1	1	1	1	-	1	1	1	1	-	1	1	1	-	-	-				
	電話接駁位 Telephone outlet	1	1	1	1	1	1	1	1	1	1	1	1	1	-	1	1	1	1	-	1	1	1	-	-	-				
	單位電插座 Single socket outlet	1	1	1	1	1	1	1	1	1	1	1	1	1	-	1	1	1	1	-	1	1	1	-	-	-				
	單位電插座 (連USB插座) Single socket outlet (with USB socket)	1	1	1	1	1	1	1	1	1	1	1	1	1	-	1	1	1	1	-	1	1	1	-	-	-				
	空調機開關掣 Switch for air-conditioner unit	1	1	1	1	1	1	1	1	1	1	1	1	1	-	1	1	1	1	-	1	1	1	-	-	-				
	燈掣 Lighting switch	1	1	1	1	1	1	1	2	1	2	1	1	1	-	1	2	1	1	-	1	2	1	-	-	-				
燈位 Lighting point	1	1	1	1	1	1	1	1	1	1	1	1	1	-	1	1	1	1	-	1	1	1	-	-	-					
睡房1 Bedroom 1	電視/電台天線接駁位 TV/FM outlet	-	-	-	-	-	-	-	-	-	-	-	-	-	1	-	-	-	-	1	-	-	-	1	1	1				
	電話接駁位 Telephone outlet	-	-	-	-	-	-	-	-	-	-	-	-	-	1	-	-	-	-	1	-	-	-	1	1	1				
	互聯網接駁位 Internet connection point	-	-	-	-	-	-	-	-	-	-	-	-	-	1	-	-	-	-	1	-	-	-	1	1	1				
	單位電插座 Single socket outlet	-	-	-	-	-	-	-	-	-	-	-	-	-	1	-	-	-	-	1	-	-	-	2	3	1				
	單位電插座 (連USB插座) Single socket outlet (with USB socket)	-	-	-	-	-	-	-	-	-	-	-	-	-	1	-	-	-	-	1	-	-	-	-	1	1				
	雙位電插座 Twin socket outlet	-	-	-	-	-	-	-	-	-	-	-	-	-	-	-	-	-	-	-	-	-	-	1	-	-				
	空調機開關掣 Switch for air-conditioner unit	-	-	-	-	-	-	-	-	-	-	-	-	-	1	-	-	-	-	1	-	-	-	1	2	1				
	電窗簾預留接駁位 Reserved connection point for electric curtain	-	-	-	-	-	-	-	-	-	-	-	-	-	-	-	-	-	-	-	-	-	-	1	1	1				
	抽氣扇開關掣 Exhaust fan switch	-	-	-	-	-	-	-	-	-	-	-	-	-	-	-	-	-	-	-	-	-	-	-	1	-				
	燈掣 Lighting switch	-	-	-	-	-	-	-	-	-	-	-	-	-	1	-	-	-	-	1	-	-	-	1	3	1				
燈位 Lighting point	-	-	-	-	-	-	-	-	-	-	-	-	-	1	-	-	-	-	1	-	-	-	3	1	1					
睡房2 Bedroom 2	電視/電台天線接駁位 TV/FM outlet	-	-	-	-	-	-	-	-	-	-	-	-	-	1	-	-	-	-	1	-	-	-	1	1	1				
	電話接駁位 Telephone outlet	-	-	-	-	-	-	-	-	-	-	-	-	-	1	-	-	-	-	1	-	-	-	1	1	1				
	互聯網接駁位 Internet connection point	-	-	-	-	-	-	-	-	-	-	-	-	-	1	-	-	-	-	1	-	-	-	1	1	1				
	單位電插座 Single socket outlet	-	-	-	-	-	-	-	-	-	-	-	-	-	1	-	-	-	-	1	-	-	-	1	1	1				
	雙位電插座 Twin socket outlet	-	-	-	-	-	-	-	-	-	-	-	-	-	-	-	-	-	-	-	-	-	-	1	-	-				
	單位電插座 (連USB插座) Single socket outlet (with USB socket)	-	-	-	-	-	-	-	-	-	-	-	-	-	1	-	-	-	-	1	-	-	-	-	1	1				
	空調機開關掣 Switch for air-conditioner unit	-	-	-	-	-	-	-	-	-	-	-	-	-	1	-	-	-	-	1	-	-	-	1	1	1				
	電窗簾預留接駁位 Reserved connection point for electric curtain	-	-	-	-	-	-	-	-	-	-	-	-	-	-	-	-	-	-	-	-	-	-	1	1	1				
	燈掣 Lighting switch	-	-	-	-	-	-	-	-	-	-	-	-	-	1	-	-	-	-	1	-	-	-	1	1	1				
燈位 Lighting point	-	-	-	-	-	-	-	-	-	-	-	-	-	1	-	-	-	-	1	-	-	-	4	1	1					

備註:

1. 上表所顯示的“1, 2,”表示提供於該住宅物業內的裝置數量。
2. 上表“-”代表不適用。
3. 第1座 (1A及1B) 不設13樓、14樓及24樓，9樓為庇護層。
4. 第2座 (2A及2B) 不設13樓、14樓、24樓及34樓，9樓為庇護層。

Notes:

1. “1, 2,” as shown in the schedule above denotes the quantity of such provision(s) provided in the residential unit.
2. The symbol “-” as shown in the schedule above denotes “Not applicable”.
3. 13/F, 14/F and 24/F are omitted in Tower 1 (1A and 1B) and 9/F is refuge floor.
4. 13/F, 14/F, 24/F and 34/F are omitted in Tower 2 (2A and 2B) and 9/F is refuge floor.

住宅物業機電裝置數量說明表

Schedule of Mechanical & Electrical Provisions of Residential Properties

位置 Location	描述 Description	第2座 (2B) Tower 2 (2B)																											
		5樓 5/F				6樓至8樓 6/F-8/F							10樓至12樓、15樓至23樓、 25樓至33樓及35樓至36樓 10/F-12/F, 15/F-23/F, 25/F-33/F & 35/F-36/F							37樓 37/F					37樓及38樓 (複式) 37/F & 38/F (Duplex)			38樓 38/F	
		A	B	C	G	A	B	C	D	E	F	G	A	B	C	E	F	G	B	C	E	F	G	A	B	C			
睡房3 Bedroom 3	電視/電台天線接駁位 TV/FM outlet	-	-	-	-	-	-	-	-	-	-	-	-	-	-	-	-	-	-	-	-	-	-	-	-	1	-		
	電話接駁位 Telephone outlet	-	-	-	-	-	-	-	-	-	-	-	-	-	-	-	-	-	-	-	-	-	-	-	-	-	1	-	
	互聯網接駁位 Internet connection point	-	-	-	-	-	-	-	-	-	-	-	-	-	-	-	-	-	-	-	-	-	-	-	-	-	1	-	
	單位電插座 Single socket outlet	-	-	-	-	-	-	-	-	-	-	-	-	-	-	-	-	-	-	-	-	-	-	-	-	-	1	-	
	單位電插座 (連USB插座) Single socket outlet (with USB socket)	-	-	-	-	-	-	-	-	-	-	-	-	-	-	-	-	-	-	-	-	-	-	-	-	-	1	-	
	空調機開關掣 Switch for air-conditioner unit	-	-	-	-	-	-	-	-	-	-	-	-	-	-	-	-	-	-	-	-	-	-	-	-	-	1	-	
	電窗簾預留接駁位 Reserved connection point for electric curtain	-	-	-	-	-	-	-	-	-	-	-	-	-	-	-	-	-	-	-	-	-	-	-	-	-	1	-	
	燈掣 Lighting switch	-	-	-	-	-	-	-	-	-	-	-	-	-	-	-	-	-	-	-	-	-	-	-	-	-	1	-	
燈位 Lighting point	-	-	-	-	-	-	-	-	-	-	-	-	-	-	-	-	-	-	-	-	-	-	-	-	-	1	-		
主人浴室 Master Bathroom	單位電插座 (鏡櫃內) Single socket outlet (at mirror cabinet)	1	-	1	-	1	-	-	-	-	-	1	-	1	-	-	-	-	1	-	-	-	1	-	2	1			
	煤氣熱水爐溫度控制器 Towngas water heater temperature controller	1	-	-	-	1	-	-	-	-	-	1	-	-	-	-	-	-	-	-	-	-	-	-	-	-	-	-	
	燈位 Lighting point	3	-	3	-	3	-	-	-	-	-	3	-	3	-	-	-	-	3	-	-	-	3	-	5	3			
	換氣暖風機隔離開關掣 Isolator for thermo ventilator	1	-	1	-	1	-	-	-	-	-	1	-	1	-	-	-	-	1	-	-	-	1	-	1	1			
	電熱水爐隔離開關掣 Isolator for electric water heater	-	-	1	-	-	-	-	-	-	-	-	-	1	-	-	-	-	1	-	-	-	1	-	1	1			
	鏡子加熱器保險菲士蘇 Fused spur unit for mirror heater	-	-	-	-	-	-	-	-	-	-	-	-	-	-	-	-	-	-	-	-	-	-	-	1	1	1		
浴室 Bathroom	單位電插座 (鏡櫃內) Single socket outlet (at mirror cabinet)	1	1	-	1	1	1	1	1	1	1	1	1	1	1	1	1	1	1	1	1	1	1	1	1	-	1		
	煤氣熱水爐溫度控制器 Towngas water heater temperature controller	1	1	-	-	1	1	-	-	1	-	-	1	1	1	-	-	1	1	1	-	-	-	-	-	-	1		
	燈位 Lighting point	3	3	-	3	3	3	3	3	3	3	3	3	3	3	3	3	3	3	3	3	3	3	3	3	3	-	3	
	抽氣扇保險菲士蘇 Fused spur unit for exhaust fan	1	-	-	-	1	-	-	-	-	-	-	1	-	1	-	-	-	1	-	-	-	1	-	-	-	-		
	換氣暖風機隔離開關掣 Isolator for thermo ventilator	-	1	-	1	-	1	1	1	1	1	-	1	-	1	1	1	1	-	1	1	1	-	-	-	-	-		
	電熱水爐隔離開關掣 Isolator for electric water heater	-	-	-	1	-	-	1	1	-	1	1	-	-	-	1	1	-	-	-	-	1	1	1	1	-	-		
	鏡子加熱器保險菲士蘇 Fused spur unit for mirror heater	-	-	-	-	-	-	-	-	-	-	-	-	-	-	-	-	-	-	-	-	-	-	-	-	1	-		

備註:

1. 上表所顯示的“1, 2,”表示提供於該住宅物業內的裝置數量。
2. 上表“-”代表不適用。
3. 第1座 (1A及1B) 不設13樓、14樓及24樓，9樓為庇護層。
4. 第2座 (2A及2B) 不設13樓、14樓、24樓及34樓，9樓為庇護層。

Notes:

1. “1, 2,” as shown in the schedule above denotes the quantity of such provision(s) provided in the residential unit.
2. The symbol “-” as shown in the schedule above denotes “Not applicable”.
3. 13/F, 14/F and 24/F are omitted in Tower 1 (1A and 1B) and 9/F is refuge floor.
4. 13/F, 14/F, 24/F and 34/F are omitted in Tower 2 (2A and 2B) and 9/F is refuge floor.

住宅物業機電裝置數量說明表
Schedule of Mechanical & Electrical Provisions of Residential Properties

位置 Location	描述 Description	第2座 (2B) Tower 2 (2B)																										
		5樓 5/F				6樓至8樓 6/F-8/F							10樓至12樓、15樓至23樓、 25樓至33樓及35樓至36樓 10/F-12/F, 15/F-23/F, 25/F-33/F & 35/F-36/F							37樓 37/F					37樓及38樓 (複式) 37/F & 38/F (Duplex)		38樓 38/F	
		A	B	C	G	A	B	C	D	E	F	G	A	B	C	E	F	G	B	C	E	F	G	A	B	C		
浴室1 Bathroom 1	單位電插座 (鏡櫃內) Single socket outlet (at mirror cabinet)	-	-	-	-	-	-	-	-	-	-	-	-	-	-	-	-	-	-	-	-	-	-	1	-			
	煤氣熱水爐溫度控制器 Towngas water heater temperature controller	-	-	-	-	-	-	-	-	-	-	-	-	-	-	-	-	-	-	-	-	-	-	1	-			
	燈位 Lighting point	-	-	-	-	-	-	-	-	-	-	-	-	-	-	-	-	-	-	-	-	-	-	3	-			
	鏡子加熱器保險非士蘇 Fused spur unit for mirror heater	-	-	-	-	-	-	-	-	-	-	-	-	-	-	-	-	-	-	-	-	-	-	1	-			
	抽氣扇保險非士蘇 Fused spur unit for exhaust fan	-	-	-	-	-	-	-	-	-	-	-	-	-	-	-	-	-	-	-	-	-	-	1	-			
浴室2 Bathroom 2	單位電插座 (鏡櫃內) Single socket outlet (at mirror cabinet)	-	-	-	-	-	-	-	-	-	-	-	-	-	-	-	-	-	-	-	-	-	-	1	-			
	煤氣熱水爐溫度控制器 Towngas water heater temperature controller	-	-	-	-	-	-	-	-	-	-	-	-	-	-	-	-	-	-	-	-	-	-	1	-			
	燈位 Lighting point	-	-	-	-	-	-	-	-	-	-	-	-	-	-	-	-	-	-	-	-	-	-	3	-			
	鏡子加熱器保險非士蘇 Fused spur unit for mirror heater	-	-	-	-	-	-	-	-	-	-	-	-	-	-	-	-	-	-	-	-	-	-	1	-			
	抽氣扇保險非士蘇 Fused spur unit for exhaust fan	-	-	-	-	-	-	-	-	-	-	-	-	-	-	-	-	-	-	-	-	-	-	1	-			
開放式廚房 Open Kitchen	暗藏式灑水器 Concealed type sprinkler	-	-	1	1	-	-	1	1	-	1	1	-	-	-	-	1	1	-	-	-	1	1	-	-	-		
	雙位電插座 Twin socket outlet	-	-	2	2	-	-	2	2	-	2	2	-	-	-	-	2	2	-	-	-	2	2	-	-	-		
	廚房電器單位電插座 Single socket outlet for kitchen appliances	-	-	2	2	-	-	2	2	-	2	2	-	-	-	-	2	2	-	-	-	2	2	-	-	-		
	抽油煙機保險非士蘇 Fused spur for cooker hood	-	-	1	1	-	-	1	1	-	1	1	-	-	-	-	1	1	-	-	-	1	1	-	-	-		
	蒸焗爐雙極開關掣 Double pole switch for combi-steam oven	-	-	1	1	-	-	1	1	-	1	1	-	-	-	-	1	1	-	-	-	1	1	-	-	-		
	蒸焗爐接線座 Connection unit for combi-steam oven	-	-	1	1	-	-	1	-	-	-	1	-	-	-	-	1	-	-	-	-	-	1	-	-	-		
	電磁爐雙極開關掣 Double pole switch for induction hob	-	-	1	1	-	-	1	1	-	1	1	-	-	-	-	1	1	-	-	-	1	1	-	-	-		
	電磁爐接線座 Connection unit for induction hob	-	-	1	1	-	-	1	-	-	-	1	-	-	-	-	1	-	-	-	-	-	1	-	-	-		
	燈位 Lighting point	-	-	2	2	-	-	2	2	-	2	2	-	-	-	-	2	2	-	-	-	2	2	-	-	-		
	總電掣箱 Miniature circuit breakers board	-	-	1	-	-	-	1	-	-	-	1	-	-	-	-	1	-	-	-	-	-	1	-	-	-		
	洗衣乾衣機來水位 Water inlet connection point for washer dryer	-	-	1	1	-	-	1	1	-	1	1	-	-	-	-	1	1	-	-	-	1	1	-	-	-		
	洗衣乾衣機去水位 Water outlet connection point for washer dryer	-	-	1	1	-	-	1	1	-	1	1	-	-	-	-	1	1	-	-	-	1	1	-	-	-		

備註:

1. 上表所顯示的“1, 2,”表示提供於該住宅物業內的裝置數量。
2. 上表“-”代表不適用。
3. 第1座 (1A及1B) 不設13樓、14樓及24樓，9樓為庇護層。
4. 第2座 (2A及2B) 不設13樓、14樓、24樓及34樓，9樓為庇護層。

Notes:

1. “1, 2,” as shown in the schedule above denotes the quantity of such provision(s) provided in the residential unit.
2. The symbol “-” as shown in the schedule above denotes “Not applicable”.
3. 13/F, 14/F and 24/F are omitted in Tower 1 (1A and 1B) and 9/F is refuge floor.
4. 13/F, 14/F, 24/F and 34/F are omitted in Tower 2 (2A and 2B) and 9/F is refuge floor.

住宅物業機電裝置數量說明表

Schedule of Mechanical & Electrical Provisions of Residential Properties

位置 Location	描述 Description	第2座 (2B) Tower 2 (2B)																												
		5樓 5/F				6樓至8樓 6/F-8/F								10樓至12樓、15樓至23樓、 25樓至33樓及35樓至36樓 10/F-12/F, 15/F-23/F, 25/F-33/F & 35/F-36/F							37樓 37/F					37樓及38樓 (複式) 37/F & 38/F (Duplex)			38樓 38/F	
		A	B	C	G	A	B	C	D	E	F	G	A	B	C	E	F	G	B	C	E	F	G	A	B	C				
廚房 Kitchen	雙位電插座 Twin socket outlet	2	2	-	-	2	2	-	-	2	-	-	2	2	2	2	-	-	2	2	2	-	-	2	2	2				
	單位電插座 Single socket outlet	2	2	-	-	2	2	-	-	2	-	-	2	2	2	2	-	-	2	2	2	-	-	4	5	5				
	焗爐雙極開關掣 Double pole switch for oven	-	-	-	-	-	-	-	-	-	-	-	-	-	-	-	-	-	-	-	-	-	-	1	1	1				
	焗爐接線座 Connection unit for oven	-	-	-	-	-	-	-	-	-	-	-	-	-	-	-	-	-	-	-	-	-	-	1	1	1				
	電磁爐雙極開關掣 Double pole switch for induction hob	1	1	-	-	1	1	-	-	1	-	-	1	1	1	1	-	-	1	1	1	-	-	1	1	1				
	電磁爐接線座 Connection unit for induction hob	1	1	-	-	1	1	-	-	1	-	-	1	1	1	1	-	-	1	1	1	-	-	1	1	1				
	蒸焗爐雙極開關掣 Double pole switch for combi-steam oven	1	1	-	-	1	1	-	-	1	-	-	1	1	1	1	-	-	1	1	1	-	-	-	-	-				
	蒸焗爐接線座 Connection unit for combi-steam oven	1	1	-	-	1	1	-	-	1	-	-	1	1	1	1	-	-	1	1	1	-	-	-	-	-				
	抽油煙機保險非士蘇 Fused spur for cooker hood	1	1	-	-	1	1	-	-	1	-	-	1	1	1	1	-	-	1	1	1	-	-	1	1	1				
	煤氣熱水爐保險非士蘇 Fused spur for gas water heater	1	1	-	-	1	1	-	-	1	-	-	1	1	1	1	-	-	1	1	1	-	-	1	1	1				
	氣體煮食爐保險非士蘇 Fused spur unit for gas hob	1	1	-	-	1	1	-	-	1	-	-	1	1	1	1	-	-	1	1	1	-	-	2	2	2				
	燈掣 Lighting switch	-	-	-	-	1	-	-	-	-	-	-	1	-	-	-	-	-	-	-	-	-	-	-	-	-				
	燈位 Lighting point	3	2	-	-	3	3	-	-	3	-	-	3	3	3	3	-	-	3	3	3	-	-	3	4	4				
	門鐘 Door bell	1	1	-	-	1	1	-	-	1	-	-	1	1	1	1	-	-	1	1	1	-	-	1	1	1				
	保安系統開關掣 Switch for security system	1	1	-	-	-	-	-	-	-	-	-	-	-	-	-	-	-	-	-	-	-	-	-	-	-				
	保安系統閃燈警鐘 Audio visual security alarm	1	1	-	-	-	-	-	-	-	-	-	-	-	-	-	-	-	-	-	-	-	-	-	-	-				
	保安系統保險非士蘇 Fused spur unit for security system	1	1	-	-	-	-	-	-	-	-	-	-	-	-	-	-	-	-	-	-	-	-	-	-	-				
	保安系統面板 Security system panel	1	1	-	-	-	-	-	-	-	-	-	-	-	-	-	-	-	-	-	-	-	-	-	-	-				
	總電掣箱 Miniature circuit breakers board	1	1	-	-	1	1	-	-	1	-	-	1	1	-	1	-	-	1	-	1	-	-	-	-	-				
	洗衣乾衣機來水位 Water inlet connection point for washer dryer	1	1	-	-	1	1	-	-	1	-	-	1	1	1	1	-	-	1	1	1	-	-	-	-	1				
	洗衣乾衣機去水位 Water outlet connection point for washer dryer	1	1	-	-	1	1	-	-	1	-	-	1	1	1	1	-	-	1	1	1	-	-	-	-	1				
	洗碗碟機來水位 Water inlet connection point for dishwasher	-	-	-	-	-	-	-	-	-	-	-	-	-	-	-	-	-	-	-	-	-	-	-	1	-				
	洗碗碟機去水位 Water outlet connection point for dishwasher	-	-	-	-	-	-	-	-	-	-	-	-	-	-	-	-	-	-	-	-	-	-	-	1	-				
抽氣扇保險非士蘇 Fused spur unit for exhaust fan	1	1	-	-	1	1	-	-	1	-	-	1	1	1	1	-	-	1	1	1	-	-	1	1	1					
空調開關掣 Switch for air-conditioner unit	-	-	-	-	-	-	-	-	-	-	-	-	-	-	-	-	-	-	-	-	-	-	1	1	1					
熱水爐保險非士蘇 Fused spur unit for gas water heater	1	1	-	-	1	1	-	-	1	-	-	1	1	1	1	-	-	1	1	1	-	-	-	1	1					
電話接駁位 Telephone outlet	-	-	-	-	-	-	-	-	-	-	-	-	-	-	-	-	-	-	-	-	-	-	1	1	1					

備註：

1. 上表所顯示的“1, 2,”表示提供於該住宅物業內的裝置數量。
2. 上表“-”代表不適用。
3. 第1座 (1A及1B) 不設13樓、14樓及24樓，9樓為庇護層。
4. 第2座 (2A及2B) 不設13樓、14樓、24樓及34樓，9樓為庇護層。

Notes:

1. “1, 2,” as shown in the schedule above denotes the quantity of such provision(s) provided in the residential unit.
2. The symbol “-” as shown in the schedule above denotes “Not applicable”.
3. 13/F, 14/F and 24/F are omitted in Tower 1 (1A and 1B) and 9/F is refuge floor.
4. 13/F, 14/F, 24/F and 34/F are omitted in Tower 2 (2A and 2B) and 9/F is refuge floor.

住宅物業機電裝置數量說明表
Schedule of Mechanical & Electrical Provisions of Residential Properties

位置 Location	描述 Description	第2座 (2B) Tower 2 (2B)																											
		5樓 5/F				6樓至8樓 6/F-8/F							10樓至12樓、15樓至23樓、 25樓至33樓及35樓至36樓 10/F-12/F, 15/F-23/F, 25/F-33/F & 35/F-36/F							37樓 37/F					37樓及38樓 (複式) 37/F & 38/F (Duplex)			38樓 38/F	
		A	B	C	G	A	B	C	D	E	F	G	A	B	C	E	F	G	B	C	E	F	G	A	B	C			
士多房 Store	調光系統 Dimmer system	-	-	-	-	-	-	-	-	-	-	-	-	-	-	-	-	-	-	-	-	-	-	1	-				
	調光系統互聯網接駁位 Internet connection point for dimmer system	-	-	-	-	-	-	-	-	-	-	-	-	-	-	-	-	-	-	-	-	-	-	-	1	-			
	調光系統單位電插座 Single socket outlet for dimmer system	-	-	-	-	-	-	-	-	-	-	-	-	-	-	-	-	-	-	-	-	-	-	-	1	-			
	總電掣箱 Miniature circuit breakers board	-	-	-	-	-	-	-	-	-	-	-	-	1	-	-	-	-	1	-	-	-	-	-	1	-			
	單位電插座 Single socket outlet	-	-	-	-	-	-	-	-	-	-	-	-	1	-	-	-	-	1	-	-	-	-	-	1	-			
	燈掣 Lighting switch	-	-	-	-	-	-	-	-	-	-	-	-	1	-	-	-	-	1	-	-	-	-	-	2	-			
	燈位 Lighting point	-	-	-	-	-	-	-	-	-	-	-	-	1	-	-	-	-	1	-	-	-	-	-	1	-			
	抽氣扇開關掣 Exhaust fan switch	-	-	-	-	-	-	-	-	-	-	-	-	-	-	-	-	-	-	-	-	-	-	-	1	-			
	乾衣機單位電插座 Single socket outlet for dryer	-	-	-	-	-	-	-	-	-	-	-	-	-	-	-	-	-	-	-	-	-	-	-	1	-			
	洗衣機單位電插座 Single socket outlet for washer	-	-	-	-	-	-	-	-	-	-	-	-	-	-	-	-	-	-	-	-	-	-	-	1	-			
	空調機開關掣 Switch for air-conditioner unit	-	-	-	-	-	-	-	-	-	-	-	-	1	-	-	-	-	1	-	-	-	-	-	1	-			
洗衣機來水位 Water inlet connection point for washer	-	-	-	-	-	-	-	-	-	-	-	-	-	-	-	-	-	-	-	-	-	-	-	1	-				
洗衣機去水位 Water outlet connection point for washer	-	-	-	-	-	-	-	-	-	-	-	-	-	-	-	-	-	-	-	-	-	-	-	1	-				
士多房 1 Store 1	調光系統 Dimmer system	-	-	-	-	-	-	-	-	-	-	-	-	-	-	-	-	-	-	-	-	-	1	-	1				
	調光系統互聯網接駁位 Internet connection point for dimmer system	-	-	-	-	-	-	-	-	-	-	-	-	-	-	-	-	-	-	-	-	-	1	-	1				
	調光系統單位電插座 Single socket outlet for dimmer system	-	-	-	-	-	-	-	-	-	-	-	-	-	-	-	-	-	-	-	-	-	1	-	1				
	總電掣箱 Miniature circuit breakers board	-	-	-	-	-	-	-	-	-	-	-	-	-	-	-	-	-	-	-	-	-	1	-	1				
	單位電插座 Single socket outlet	-	-	-	-	-	-	-	-	-	-	-	-	-	-	-	-	-	-	-	-	-	1	-	1				
	燈掣 Lighting switch	-	-	-	-	-	-	-	-	-	-	-	-	-	-	-	-	-	-	-	-	-	1	-	1				
	燈位 Lighting point	-	-	-	-	-	-	-	-	-	-	-	-	-	-	-	-	-	-	-	-	-	2	-	1				
	抽氣扇開關掣 Exhaust fan switch	-	-	-	-	-	-	-	-	-	-	-	-	-	-	-	-	-	-	-	-	-	1	-	1				
	洗衣機單位電插座 Single socket outlet for washer	-	-	-	-	-	-	-	-	-	-	-	-	-	-	-	-	-	-	-	-	-	1	-	-				
	空調機開關掣 Switch for air-conditioner unit	-	-	-	-	-	-	-	-	-	-	-	-	-	-	-	-	-	-	-	-	-	1	-	1				
洗衣機來水位 Water inlet connection point for washer	-	-	-	-	-	-	-	-	-	-	-	-	-	-	-	-	-	-	-	-	-	1	-	-					
洗衣機去水位 Water outlet connection point for washer	-	-	-	-	-	-	-	-	-	-	-	-	-	-	-	-	-	-	-	-	-	1	-	-					
士多房 2 Store 2	燈掣 Lighting switch	-	-	-	-	-	-	-	-	-	-	-	-	-	-	-	-	-	-	-	-	1	-	1					
	燈位 Lighting point	-	-	-	-	-	-	-	-	-	-	-	-	-	-	-	-	-	-	-	-	1	-	1					
37樓走廊 37/F Corridor	燈掣 Lighting switch	-	-	-	-	-	-	-	-	-	-	-	-	-	-	-	-	-	-	-	-	3	-	-					
	燈位 Lighting point	-	-	-	-	-	-	-	-	-	-	-	-	-	-	-	-	-	-	-	-	5	-	-					
	單位電插座 Single socket outlet	-	-	-	-	-	-	-	-	-	-	-	-	-	-	-	-	-	-	-	-	1	-	-					
	抽氣扇開關掣 Exhaust fan switch	-	-	-	-	-	-	-	-	-	-	-	-	-	-	-	-	-	-	-	-	1	-	-					

備註：

1. 上表所顯示的“1, 2,”表示提供於該住宅物業內的裝置數量。
2. 上表“-”代表不適用。
3. 第1座 (1A及1B) 不設13樓、14樓及24樓，9樓為庇護層。
4. 第2座 (2A及2B) 不設13樓、14樓、24樓及34樓，9樓為庇護層。

Notes:

1. “1, 2,” as shown in the schedule above denotes the quantity of such provision(s) provided in the residential unit.
2. The symbol “-” as shown in the schedule above denotes “Not applicable”.
3. 13/F, 14/F and 24/F are omitted in Tower 1 (1A and 1B) and 9/F is refuge floor.
4. 13/F, 14/F, 24/F and 34/F are omitted in Tower 2 (2A and 2B) and 9/F is refuge floor.

住宅物業機電裝置數量說明表
Schedule of Mechanical & Electrical Provisions of Residential Properties

位置 Location	描述 Description	第2座 (2B) Tower 2 (2B)																											
		5樓 5/F				6樓至8樓 6/F-8/F							10樓至12樓、15樓至23樓、 25樓至33樓及35樓至36樓 10/F-12/F, 15/F-23/F, 25/F-33/F & 35/F-36/F							37樓 37/F					37樓及38樓 (複式) 37/F & 38/F (Duplex)			38樓 38/F	
		A	B	C	G	A	B	C	D	E	F	G	A	B	C	E	F	G	B	C	E	F	G	A	B	C			
樓梯 Staircase	燈掣 Lighting switch	-	-	-	-	-	-	-	-	-	-	-	-	-	-	-	-	-	-	-	-	-	-	-	3	-	-		
	燈位 Lighting point	-	-	-	-	-	-	-	-	-	-	-	-	-	-	-	-	-	-	-	-	-	-	-	14	-	-		
	空調機開關掣 Switch for air-conditioner unit	-	-	-	-	-	-	-	-	-	-	-	-	-	-	-	-	-	-	-	-	-	-	-	1	-	-		
洗手間 Lavatory	燈位 Lighting point	-	-	-	-	-	-	-	-	-	-	-	-	-	-	-	-	-	-	-	-	-	-	-	1	1	1		
	煤氣熱水爐溫度控制器 Towngas water heater temperature controller	-	-	-	-	-	-	-	-	-	-	-	-	-	-	-	-	-	-	-	-	-	-	-	1	1	1		
	抽氣扇保險菲士蘇 Fused spur unit for exhaust fan	-	-	-	-	-	-	-	-	-	-	-	-	-	-	-	-	-	-	-	-	-	-	-	1	1	1		
露台 Balcony	燈位 Lighting point	-	-	-	-	1	1	1	1	1	1	1	1	1	1	1	1	1	1	1	1	1	1	1	1	1	1		
工作平台 Utility Platform	燈位 Lighting point	-	-	-	-	1	1	1	-	1	-	1	1	1	1	-	1	1	1	1	-	1	-	-	-	-	-		
平台 Flat Roof	燈位 Lighting point	-	-	-	-	-	-	-	-	-	-	-	-	-	-	-	-	-	-	-	-	-	-	-	-	2	-		
私人天台 Private Roof	防水單位電插座 Waterproof single socket outlet	-	-	-	-	-	-	-	-	-	-	-	-	-	-	-	-	-	-	-	-	-	-	-	2	2	2		
	室外空調機隔離開關掣 Isolator for outdoor air-conditioner unit	-	-	-	-	-	-	-	-	-	-	-	-	-	-	-	-	-	-	-	-	-	-	-	2	3	2		
	燈位 Lighting point	-	-	-	-	-	-	-	-	-	-	-	-	-	-	-	-	-	-	-	-	-	-	-	7	16	13		
	消防喉轆 Fire services hose reel	-	-	-	-	-	-	-	-	-	-	-	-	-	-	-	-	-	-	-	-	-	-	-	1	1	1		
	消防掣手 Fire services breakglass unit	-	-	-	-	-	-	-	-	-	-	-	-	-	-	-	-	-	-	-	-	-	-	-	1	1	1		
	消防警鐘 Fire services alarm bell	-	-	-	-	-	-	-	-	-	-	-	-	-	-	-	-	-	-	-	-	-	-	1	1	1			
私人花園 Private Garden	防水單位電插座 Waterproof single socket outlet	2	2	-	-	-	-	-	-	-	-	-	-	-	-	-	-	-	-	-	-	-	-	-	-	-	-		
	動作傳感器 Motion sensor	1	1	-	-	-	-	-	-	-	-	-	-	-	-	-	-	-	-	-	-	-	-	-	-	-	-		
	燈位 Lighting point	5	4	-	-	-	-	-	-	-	-	-	-	-	-	-	-	-	-	-	-	-	-	-	-	-	-		
	洗滌盆去水位 Water outlet connection point for sink	1	1	-	-	-	-	-	-	-	-	-	-	-	-	-	-	-	-	-	-	-	-	-	-	-	-		
	洗滌盆來水位 Water inlet connection point for sink	1	1	-	-	-	-	-	-	-	-	-	-	-	-	-	-	-	-	-	-	-	-	-	-	-	-		
空調機平台 Air-Conditioner Platform	室外空調機隔離開關掣 Isolator for outdoor air-conditioner unit	-	-	-	-	2	2	1	1	2	1	2	2	2	3	2	1	2	2	3	2	1	2	-	-	-			
鋼筋混凝土基座 Reinforced Concrete Plinth	室外空調機隔離開關掣 Isolator for outdoor air-conditioner unit	2	2	1	2	-	-	-	-	-	-	-	-	-	-	-	-	-	-	-	-	-	-	-	-	-	-		

備註:

1. 上表所顯示的“1, 2,”表示提供於該住宅物業內的裝置數量。
2. 上表“-”代表不適用。
3. 第1座 (1A及1B) 不設13樓、14樓及24樓，9樓為庇護層。
4. 第2座 (2A及2B) 不設13樓、14樓、24樓及34樓，9樓為庇護層。

Notes:

1. “1, 2,” as shown in the schedule above denotes the quantity of such provision(s) provided in the residential unit.
2. The symbol “-” as shown in the schedule above denotes “Not applicable”.
3. 13/F, 14/F and 24/F are omitted in Tower 1 (1A and 1B) and 9/F is refuge floor.
4. 13/F, 14/F, 24/F and 34/F are omitted in Tower 2 (2A and 2B) and 9/F is refuge floor.

24 服務協議 SERVICE AGREEMENTS

食水及沖廁水由水務署供應。
電力由香港電燈有限公司供應。
煤氣由香港中華煤氣有限公司供應。

Potable and flushing water is supplied by Water Supplies Department.
Electricity is supplied by The Hongkong Electric Company, Limited.
Towngas is supplied by The Hong Kong and China Gas Company Limited.

25 地稅 GOVERNMENT RENT

擁有人（即香港鐵路有限公司）有法律責任就指明住宅物業繳付直至並包括有關個別指明住宅物業之轉讓契之日期為止的地稅。

The Owner (i.e. MTR Corporation Limited) is liable for the Government rent payable for the specified residential properties up to and including the date of the respective assignments of the specified residential properties.

26 買方的雜項付款 MISCELLANEOUS PAYMENTS BY PURCHASER

1. 在向買方交付指明住宅物業在空置情況下的管有權時，買方須負責向擁有人（即香港鐵路有限公司）補還水、電力及氣體的按金。
2. 在交付時，買方不須向擁有人支付清理廢料的費用。

備註：

1. 在交付時，買方須根據主公契向期數的管理人（而非擁有人）支付清理廢料的費用，而如擁有人已支付清理廢料的費用，買方須向擁有人補還清理廢料的費用。

1. On the delivery of the vacant possession of the specified residential property to the purchaser, the purchaser is liable to reimburse the Owner (i.e. MTR Corporation Limited) for the deposits for water, electricity and gas.
2. On that delivery, the purchaser is not liable to pay to the Owner a debris removal fee.

Note:

1. On that delivery, the purchaser is liable to pay a debris removal fee to the manager (not the Owner) of the Phase under the Principal Deed of Mutual Covenant and where the Owner has paid that debris removal fee, the purchaser shall reimburse the Owner for the same.

27 欠妥之處的保養責任期 DEFECT LIABILITY WARRANTY PERIOD

凡任何指明住宅物業或於買賣合約列出裝設於該物業內的裝置、裝修物料或設備有欠妥之處，而該欠妥之處並非由買方的行為或疏忽造成，則賣方在接獲買方在買賣成交日期後的6個月內送達的書面通知後，須於合理地切實可行的範圍內，盡快自費作出補救。

The Vendor shall, at its own cost and as soon as reasonably practicable after receipt of a written notice served by the purchaser within 6 months after the date of completion of the sale and purchase of any specified residential property, remedy any defects in such property, or the fittings, finishes or appliances incorporated into such property as set out in the agreement for sale and purchase concerned, caused otherwise than by the act or neglect of the purchaser.

28 斜坡維修 MAINTENANCE OF SLOPES

不適用

Not applicable

29 修訂 MODIFICATION

不適用

Not applicable

噪音緩解措施

期數興建或安裝下文所列之噪音緩解措施。

- a. 隔音簷篷
於園景平台以外約1米至3米興建隔音簷篷。
- b. 隔音窗
於以下第1座(1A及1B)單位安裝隔音窗：
 - 第1座(1A) 10樓至12樓、15樓至23樓及25樓至29樓A單位主人睡房
 - 第1座(1A) 10樓至12樓、15樓至23樓及25樓至26樓A單位睡房1
 - 第1座(1A) 10樓至12樓、15樓至23樓及25樓至26樓A單位睡房2
 - 第1座(1A) 10樓至12樓、15樓至23樓及25樓至31樓A單位睡房3
 - 第1座(1A) 12樓、15樓至23樓及25樓至31樓B單位主人睡房
 - 第1座(1A) 11樓至12樓、15樓至23樓及25樓至30樓B單位睡房1
 - 第1座(1A) 11樓至12樓、15樓至23樓及25樓至30樓B單位睡房2
 - 第1座(1A) 32樓A單位睡房1
 - 第1座(1B) 7樓至8樓、10樓至12樓、15樓至23樓及25樓至29樓A單位主人睡房
 - 第1座(1B) 11樓至12樓及15樓至21樓A單位睡房1
 - 第1座(1B) 10樓至12樓及15樓至23樓A單位睡房2
 - 第1座(1B) 10樓至12樓、15樓至23樓及25樓至31樓A單位睡房3
- c. 隔音露台
於以下第1座(1A及1B)單位安裝隔音露台：
 - 第1座(1A) 10樓至12樓、15樓至23樓及25樓至30樓A單位
 - 第1座(1A) 10樓至12樓、15樓至23樓及25樓至30樓B單位
 - 第1座(1B) 12樓及15樓至21樓A單位
- d. 自動關閉門
於以下第1座(1A)單位之工作平台安裝自動關閉門：
 - 第1座(1A) 12樓、15樓至23樓及25樓至31樓B單位
- e. 吸音物料牆身
於以下第1座(1A及1B)單位之露台分隔牆位置安裝吸音物料牆身：
 - 第1座(1A) 8樓及31樓A單位
 - 第1座(1A) 8樓及31樓B單位
 - 第1座(1B) 10樓至11樓、22樓至23樓及25樓至31樓A單位
 - 第1座(1B) 11樓至12樓、15樓至23樓及25樓至31樓B單位

備註：

1. 第1座(1A及1B)不設13樓、14樓及24樓，9樓為庇護層。
2. 第2座(2A及2B)不設13樓、14樓、24樓及34樓，9樓為庇護層。

Noise Mitigation Measures

The noise mitigation measures specified below are constructed or implemented in the Phase.

- a. Noise Canopy
Noise canopy with approximately 1.0m – 3.0m extent from landscape deck.
- b. Acoustic Window
Acoustic windows are provided for the following units in Tower 1 (1A and 1B):
 - Master Bedroom of Unit A on 10/F-12/F, 15/F-23/F and 25/F-29/F of Tower 1 (1A)
 - Bedroom 1 of Unit A on 10/F-12/F, 15/F-23/F and 25/F-26/F of Tower 1 (1A)
 - Bedroom 2 of Unit A on 10/F-12/F, 15/F-23/F and 25/F-26/F of Tower 1 (1A)
 - Bedroom 3 of Unit A on 10/F-12/F, 15/F-23/F and 25/F-31/F of Tower 1 (1A)
 - Master Bedroom of Unit B on 12/F, 15/F-23/F and 25/F-31/F of Tower 1 (1A)
 - Bedroom 1 of Unit B on 11/F-12/F, 15/F-23/F and 25/F-30/F of Tower 1 (1A)
 - Bedroom 2 of Unit B on 11/F-12/F, 15/F-23/F and 25/F-30/F of Tower 1 (1A)
 - Bedroom 1 of Unit A on 32/F of Tower 1 (1A)
 - Master Bedroom of Unit A on 7/F-8/F, 10/F-12/F, 15/F-23/F and 25/F-29/F of Tower 1 (1B)
 - Bedroom 1 of Unit A on 11/F-12/F and 15/F-21/F of Tower 1 (1B)
 - Bedroom 2 of Unit A on 10/F-12/F and 15/F-23/F of Tower 1 (1B)
 - Bedroom 3 of Unit A on 10/F-12/F, 15/F-23/F and 25/F-31/F of Tower 1 (1B)
- c. Acoustic Balcony
Acoustic balconies are provided for the following units in Tower 1 (1A and 1B):
 - Unit A on 10/F-12/F, 15/F-23/F and 25/F-30/F of Tower 1 (1A)
 - Unit B on 10/F-12/F, 15/F-23/F and 25/F-30/F of Tower 1 (1A)
 - Unit A on 12/F and 15/F-21/F of Tower 1 (1B)
- d. Self-closing Door
Self-closing door is provided at the utility platform of the following units in Tower 1 (1A):
 - Unit B on 12/F, 15/F-23/F and 25/F-31/F of Tower 1 (1A)
- e. Noise Absorptive Wall Lining
Noise absorptive wall linings are provided at the separation wall of balconies of the following unit in Tower 1 (1A and 1B):
 - Unit A on 8/F and 31/F of Tower 1 (1A)
 - Unit B on 8/F and 31/F of Tower 1 (1A)
 - Unit A on 10/F-11/F, 22/F-23/F and 25/F-31/F of Tower 1 (1B)
 - Unit B on 11/F-12/F, 15/F-23/F and 25/F-31/F of Tower 1 (1B)

Note :

1. 13/F, 14/F and 24/F are omitted in Tower 1 (1A and 1B) and 9/F is refuge floor.
2. 13/F, 14/F, 24/F and 34/F are omitted in Tower 2 (2A and 2B) and 9/F is refuge floor.

賣方為施行《一手住宅物業銷售條例》(第621章)第2部而就期數指定的互聯網網站的網址為：
www.lamarina.com.hk

The address of the website designated by the Vendor for the Phase for the purposes of part 2 of the Residential Properties (First-hand Sales) Ordinance (Cap. 621) is: www.lamarina.com.hk

獲寬免總樓面面積的設施分項

Breakdown of GFA Concessions Obtained for All Features

於印製售樓說明書前呈交予並已獲建築事務監督批准的一般建築圖則上有關總樓面面積寬免的分項的最新資料，請見下表。如印製售樓說明書時尚未呈交最終修訂圖則予建築事務監督，則有(#)號的資料可以由認可人士提供的資料作為基礎。直至最終修訂圖則於發出期數估用許可證前呈交予並獲建築事務監督批准前，以下分項資料仍可能有所修改。

Latest information on breakdown of GFA concessions as shown on the general building plans submitted to and approved by the Building Authority (BA) prior to the printing of the sales brochure is tabulated below. Information marked (#) may be based on information provided by the Authorized Person if the sales brochure is printed prior to submission of the final amendment plans to the BA. The breakdown of GFA concessions may be subject to further changes until final amendment plans are submitted to and approved by the BA prior to the issuance of the occupation permit for the Phase.

		面積 (平方米) Area (m ²)
根據《建築物(規劃)規例》第23(3)(b)條不計算的總樓面面積 Disregarded GFA under Building (Planning) Regulations 23(3)(b)		
1(#)	停車場及上落客貨地方 (公共交通總站除外) Carpark and loading/unloading area excluding public transport terminus	4,265.923
2	機房及相類設施 Plant rooms and similar services	
2.1	所佔面積受相關《認可人士、註冊結構工程師及註冊岩土工程師作業備考》(《作業備考》)或規例限制的強制性設施或必要機房，例如升降機機房、電訊及廣播設備室、垃圾及物料回收房等 Mandatory feature or essential plant room, area of which is limited by respective Practice Notes for Authorized Persons, Registered Structural Engineers and Registered Geotechnical Engineers (PNAP) or regulation such as lift machine room, telecommunications and broadcasting (TBE) room, refuse storage and material recovery chamber, etc.	440.149
2.2(#)	所佔面積不受任何《作業備考》或規例限制的強制性設施或必要機房，例如僅由消防裝置及設備佔用的房間、電錶房、電力變壓房、食水及鹹水缸等 Mandatory feature or essential plant room, area of which is NOT limited by any PNAP or regulation such as room occupied solely by fire services installations (FSI) and equipment, meter room, transformer room, potable and flushing water tank, etc.	3,154.850
2.3	非強制性或非必要機房，例如空調機房、送風櫃房等 Non-mandatory or non-essential plant room such as air-conditioning (A/C) plant room, air handling unit (AHU) room, etc.	110.112
根據聯合作業備考第1號及第2號提供的環保設施 Green Features under Joint Practice Notes 1 and 2		
3	露台 Balcony	801.445
4	加闊的公用走廊及升降機大堂 Wider common corridor and lift lobby	1,112.099
5	公用空中花園 Communal sky garden	不適用 Not applicable
6.	隔聲鰭 Acoustic fin	不適用 Not applicable
7	翼牆、捕風器及風斗 Wing wall, wind catcher and funnel	不適用 Not applicable

8.	非結構預製外牆 Non-structural prefabricated external wall	432.345
9	工作平台 Utility platform	418.356
10	隔音屏障 Noise barrier	274.525
適意設施 Amenity Features		
11	管理員宿舍、供保安人員和管理處員工使用的櫃位、辦事處、貯物室、警衛室和廁所，以及業主立案法團辦事處 Caretaker's quarters, counter, office, store, guard room and lavatory for watchman and management staff and owners' corporation office	57.963
12	住戶康樂設施，包括僅供康樂設施使用的中空空間、機房、游泳池的濾水機房、有蓋人行道等 Residential recreational facilities including void, plant room, swimming pool filtration plant room, covered walkway, etc. serving solely the recreational facilities	1,141.509
13	有蓋園景區及遊樂場地 Covered landscaped and play area	1,319.546
14	橫向屏障/有蓋人行道及花棚 Horizontal screen/covered walkway and trellis	25.913
15	擴大升降機槽 Larger lift shaft	450.231
16	煙囪管道 Chimney shaft	不適用 Not applicable
17	其他非強制性或非必要機房，例如鍋爐房、衛星電視共用天線房 Other non-mandatory or non-essential plant room, such as boiler room, satellite master antenna television (SMATV) room	27.148
18(#)	強制性設施或必要機房所需的管槽及氣槽 Pipe duct, air duct for mandatory feature or essential plant room	1,217.336
19	非強制性設施或非必要機房所需的管槽及氣槽 Pipe duct, air duct for non-mandatory or non-essential plant room	1.036
20	環保系統及設施所需的機房、管槽及氣槽 Plant room, pipe duct, air duct for environmentally friendly system and feature	不適用 Not applicable
21	複式住宅單位及洋房的中空空間 Void in duplex domestic flat and house	不適用 Not applicable
22	遮陽篷及反光罩 Sunshade and reflector	不適用 Not applicable
23(#)	小型伸出物，例如空調機箱、空調機平台、窗檻及伸出的窗台 Minor projection such as A/C box, A/C platform, window cill and projecting window	不適用 Not applicable
24	《作業備考》APP-19 第3(b)及(c)段沒有涵蓋的其他伸出物，如空調機箱及空調機平台 Other projection such as A/C box and platform not covered in paragraph 3(b) and (c) of PNAP APP-19	不適用 Not applicable

其他寬免項目 Other Exempted Items		
25(#)	庇護層，包括庇護層兼空中花園 Refuge floor including refuge floor cum sky garden	1,477.252
26	大型伸出/外懸設施下的有蓋地方 Covered area under large projecting/overhanging feature	不適用 Not applicable
27	公共交通總站 Public transport terminus	不適用 Not applicable
28(#)	共用構築物及公用樓梯 Party structure and common staircase	不適用 Not applicable
29(#)	僅供獲接納不計入總樓面面積的樓層使用的樓梯、升降機槽及垂直管道的水平面積 Horizontal area of staircase, lift shaft and vertical duct solely serving floor accepted as not being accountable for GFA	701.747
30	公眾通道 Public passage	不適用 Not applicable
31	有蓋的後移部分 Covered set back area	不適用 Not applicable
額外總樓面面積 Bonus GFA		
32	額外總樓面面積 Bonus GFA	不適用 Not applicable
根據聯合作業備考（第8號）提供的額外環保設施 Additional Green Features under Joint Practice Note (No. 8)		
33	採用「組裝合成」建築法的樓宇 Buildings adopting Modular Integrated Construction	不適用 Not applicable

備註：

上述表格是根據屋宇署所發出的《認可人士、註冊結構工程師及註冊岩土工程師作業備考》ADM-2規定的要求而制訂的。屋宇署會按實際需要不時更改有關要求。

Note :

The above table is based on the requirements as stipulated in the Practice Note for Authorized Persons, Registered Structural Engineers and Registered Geotechnical Engineers ADM-2 issued by the Buildings Department. The Buildings Department may revise such requirements from time to time as appropriate.

建築物的環境評估

Environmental Assessment of the Building



期數的公用部分的預計能量表現或消耗

Estimated Energy Performance or Consumption for the Common Parts of the Phase

於印製售樓說明書前呈交予建築事務監督期數的公用部份的預計能量表現或消耗的最近期資料：

Latest information on the estimated energy performance or consumption for the common parts of the Phase as submitted to the Building Authority prior to the printing of the sales brochure:

第I部分 Part I	
提供中央空調 Provision of central air conditioning	否 NO
提供具能源效益的設施 Provision of energy efficient features	是 YES
擬安裝的具能源效益的設施 Energy efficient features proposed	1. 高 COP 值空調機 High COP A/C Units
	2. 發光二極管或 T5 熒光管燈 LED or T5 fluorescent lighting

第II部分：擬興建樓宇/部分樓宇預計每年能源消耗量^(註腳1)Part II : The predicted annual energy use of the proposed building / part of building^(Note 1)

位置 Location	使用有關裝置的內部樓面面積 (平方米) Internal floor area served (m ²)	基線樓宇 ^(註腳2) 每年能源消耗量 Annual energy use of baseline building ^(Note 2)		擬興建樓宇每年能源消耗量 Annual energy use of proposed building	
		電力 千瓦小時/平方米/年 Electricity kWh / m ² / annum	煤氣/石油氣 用量單位/平方米/年 Town Gas / LPG unit / m ² / annum	電力 千瓦小時/平方米/年 Electricity kWh / m ² / annum	煤氣/石油氣 用量單位/平方米/年 Town Gas / LPG unit / m ² / annum
有使用中央屋宇裝備裝置 ^(註腳3) 的部分 Area served by central building services installation ^(Note 3)	11,161.394	155.02	不適用 Not applicable	133.86	不適用 Not applicable

32 申請建築物總樓面面積寬免的資料

INFORMATION IN APPLICATION FOR CONCESSION ON GROSS FLOOR AREA OF BUILDING

第III部分：以下裝置乃按機電工程署公布的相關實務守則設計 Part III : The following installations are designed in accordance with the relevant Codes of Practices published by the Electrical & Mechanical Services Department (EMSD)			
裝置類型 Type of installations	是 YES	否 NO	不適用 NOT APPLICABLE
照明裝置 Lighting installations	✓		
空調裝置 Air conditioning installations	✓		
電力裝置 Electrical installations	✓		
升降機及自動梯的裝置 Lift & Escalator installations	✓		
以總能源為本的方法 Performance-based approach			✓

註腳：

- 一般而言，一棟樓宇的預計“每年能源消耗量”愈低，其節約能源的效益愈高。如一棟樓宇預計的“每年能源消耗量”低於該樓宇的“基線樓宇每年能源消耗量”，則代表預計該樓宇的能源應用較其基線樓宇有效，削減幅度愈大則代表有關樓宇能源節約的效益愈高。
預計每年能源消耗量 [以耗電量 (千瓦小時 / 平方米 / 年) 及煤氣 / 石油氣消耗量 (用量單位 / 平方米 / 年) 計算] ，指將發展項目的每年能源消耗總量除以使用有關裝置的內部樓面面積所得出的商，其中：
(a) “每年能源消耗量”與新建樓宇 BEAM Plus 標準 (現行版本) 中的「年能源消耗」具有相同涵義；及
(b) 樓宇、空間或單位的“內部樓面面積”，指外牆及 / 或共用牆的內壁之內表面起量度出來的樓面面積。
- “基準樓宇”與新建樓宇 BEAM Plus 標準 (現行版本) 中的“基準建築物模式 (零分標準) ”具有相同涵義。
- “中央屋宇裝備裝置”與機電工程署發出的《屋宇裝備裝置能源效益實務守則》中的涵義相同。

Notes :

- In general, the lower the estimated “Annual Energy Use” of the building, the more efficient of the building in terms of energy use. For example, if the estimated “annual energy use of proposed building” is less than the estimated “annual energy use of baseline building”, it means the predicted use of energy is more efficient in the proposed building than in the baseline building. The larger the reduction, the greater the efficiency.
The predicted annual energy use, in terms of electricity consumption (kWh/m²/annum) and town gas/LPG consumption (unit/m²/annum), of the development by the internal floor area served, where:
(a) “total annual energy use” has the same meaning of “annual energy use” in the BEAM Plus New Buildings (current version); and
(b) “internal floor area”, in relation a building, a space or a unit means the floor area of all enclosed space measured to the internal faces of enclosing external and/or party walls.
- “Baseline Building” has the same meaning as “Baseline Building Model (zero-credit benchmark)” in the BEAM Plus New Buildings (current version).
- “Central Building Services Installation” has the same meaning as that in the Code of Practice for Energy Efficiency of Building Services Installation issued by the Electrical and Mechanical Services Department.



This page is intentionally left blank.
此頁乃特意留白。

期數及其周邊地區日後可能出現改變。
There may be future changes to the Phase and the surrounding areas.

印製日期：2021年8月16日
Date of Printing：16 August 2021

檢視紀錄
Examination Record

檢視 / 修改日期 Examination / Revision Date	所作修改 Revision Made	
	頁次 Page Number	所作修改 Revision Made
2021年10月31日 31 October 2021	14	更新發展項目的所在位置圖 Location plan of the Development is updated
	158, 159, 168, 169 & 189	更新裝置、裝修物料及設備 Fittings, Finishes and Appliances are updated
	225	更新修訂 Modification is updated
2021年12月29日 29 December 2021	14	更新發展項目的所在位置圖 Location plan of the Development is updated
	20	更新發展項目的布局圖 Layout plan of the Development is updated
	24, 26, 28, 30, 32, 34, 36, 38, 40, 42, 44 & 46	更新期數的住宅物業的樓面平面圖 Floor plans of Residential Properties in the Phase are updated
	60 & 61	更新期數中的停車位的樓面平面圖 Floor plans of Parking Spaces in the Phase are updated
	64 & 70	更新公契的摘要 Summary of Deed of Mutual Covenant is updated
	145	更新公共設施及公眾休憩用地的資料 Information on Public Facilities and Public Open Spaces is updated
	148 & 149	更新期數中的建築物的橫截面圖 Cross-section plans of Building in the Phase are updated
	150-154	更新立面圖 Elevation plans are updated
	155	更新期數中的公用設施的資料 Information on Common Facilities in the Phase is updated
228-230	更新申請建築物總樓面面積寬免的資料 Information in Application for Concession on Gross Floor Area of Building is updated	

檢視 / 修改日期 Examination / Revision Date	所作修改 Revision Made	
	頁次 Page Number	所作修改 Revision Made
2022年3月29日 29 March 2022	14	更新發展項目的所在位置圖 Location plan of the Development is updated
	16, 17 & 18	更新期數的鳥瞰照片 Aerial photographs of the Phase are updated
	20	更新發展項目的布局圖 Layout plan of the Development is updated
	26, 30, 32, 34, 36 & 46	更新期數的住宅物業的樓面平面圖 Floor plans of Residential Properties in the Phase are updated
	60 & 61	更新期數中的停車位的樓面平面圖 Floor plans of Parking Spaces in the Phase are updated
	145	更新公共設施及公眾休憩用地的資料 Information on Public Facilities and Public Open Spaces is updated
2022年6月8日 8 June 2022	150, 151, 152 & 153	更新立面圖 Elevation plans are updated
	155	更新期數中的公用設施的資料 Information on Common Facilities in the Phase is updated
2022年6月8日 8 June 2022	14	更新發展項目的所在位置圖 Location plan of the Development is updated

檢視紀錄
Examination Record

檢視 / 修改日期 Examination / Revision Date	所作修改 Revision Made	
	頁次 Page Number	所作修改 Revision Made
2022年9月8日 8 September 2022	14	更新發展項目的所在位置圖 Location plan of the Development is updated
	16 & 17	更新期數的鳥瞰照片 Aerial photographs of the Phase are updated
	20 & 21	更新發展項目的布局圖 Layout plan of the Development is updated
	26, 32, 34, 36 & 42	更新期數的住宅物業的樓面平面圖 Floor plans of Residential Properties in the Phase are updated
	60 & 61	更新期數中的停車位的樓面平面圖 Floor plans of Parking Spaces in the Phase are updated
	64 & 70	更新公契的摘要 Summary of Deed of Mutual Covenant is updated
	80 & 91	更新批地文件的摘要 Summary of Land Grant is updated
	106, 112, 113, 115, 119, 120, 122, 130, 131, 132, 134, 140 & 142	更新公共設施及公眾休憩用地的資料 Information on Public Facilities and Public Open Spaces is updated
	150, 151, 152, 153 & 154	更新立面圖 Elevation plans are updated
	155	更新期數中的公用設施的資料 Information on Common Facilities in the Phase is updated
	158, 159, 162, 163, 170 & 171	更新裝置、裝修物料及設備 Fittings, Finishes and Appliances are updated
	225	更新修訂 Modification is updated
228, 229 & 230	更新申請建築物總樓面面積寬免的資料 Information in Application for Concession on Gross Floor Area of Building is updated	

檢視 / 修改日期 Examination / Revision Date	所作修改 Revision Made	
	頁次 Page Number	所作修改 Revision Made
2022年12月8日 8 December 2022	8	更新期數的資料 Information on the Phase is updated
	14	更新發展項目的所在位置圖 Location plan of the Development is updated
	17	更新期數的鳥瞰照片 Aerial photographs of the Phase are updated
	20 & 21	更新發展項目的布局圖 Layout plan of the Development is updated
	156, 157, 158, 159, 160, 161, 170, 171, 192, 193, 194, 195, 196, 197, 198, 199, 212, 217, 218, 221, 222 & 223 (158A, 159A (additional pages 加頁))	更新裝置、裝修物料及設備 Fittings, Finishes and Appliances are updated
	14	更新發展項目的所在位置圖 Location plan of the Development is updated
2023年3月8日 8 March 2023	20 & 21	更新發展項目的布局圖 Layout plan of the Development is updated
	143, 144, 145 & 146	更新公共設施及公眾休憩用地的資料 Information on Public Facilities and Public Open Spaces is updated
	158, 159, 158A, 159A, 162, 171	更新裝置、裝修物料及設備 Fittings, Finishes and Appliances are updated

檢視紀錄
Examination Record

檢視 / 修改日期 Examination / Revision Date	所作修改 Revision Made	
	頁次 Page Number	所作修改 Revision Made
2023年6月8日 8 June 2023	4, 7	更新一手住宅物業買家須知 Notes to purchasers of first-hand residential properties are updated
	8	更新期數的資料 Information on the Phase is updated
	11, 12	更新期數的設計的資料 Information on design of the Phase is updated
	13	更新物業管理的資料 Information on property management is updated
	14	更新發展項目的所在位置圖 Location plan of the Development is updated
	21	更新發展項目的布局圖 Layout Plan of the Development is updated
	64, 70	更新公契的摘要 Summary of deed of mutual covenant is updated
	121, 142, 144, 145, 146	公共設施及公眾休憩用地的資料 Information on Public Facilities and Public Open Spaces is updated
	155	更新閱覽圖則及公契 Inspection of Plans and Deed of Mutual Covenant is updated
	224	更新買方的雜項付款 Miscellaneous Payments by Purchaser is updated
226	更新有關資料 Relevant Information is updated	
233	刪除地政總署署長作為給予預售樓花同意書的條件而規定列於售樓說明書的資料 Information required by the Director of Lands to be set out in the sales brochure as a condition for giving the presale consent is deleted	

檢視 / 修改日期 Examination / Revision Date	所作修改 Revision Made	
	頁次 Page Number	所作修改 Revision Made
2023年9月8日 8 September 2023	14	更新發展項目的所在位置圖 Location plan of the Development is updated
	40	更新期數的住宅物業的樓面平面圖 Floor plan of Residential Properties in the Phase is updated
	228, 229, 230, 232	更新申請建築物總樓面面積寬免的資料 Information in Application for Concession on Gross Floor Area of Building is updated
2023年12月8日 8 December 2023	14	更新發展項目的所在位置圖 Location plan of the Development is updated
	16 & 17	更新期數的鳥瞰照片 Aerial photographs of the Phase are updated
	20	更新發展項目的布局圖 Layout Plan of the Development is updated
2024年3月1日 1 March 2024	14	更新發展項目的所在位置圖 Location plan of the Development is updated
	18	更新期數的鳥瞰照片 Aerial photograph of the Phase is updated
	20	更新發展項目的布局圖 Layout Plan of the Development is updated

